

ARMY TECHNICAL MANUAL
AIR FORCE TECHNICAL ORDER
NAVY PUBLICATION
MARINE CORPS STOCK LIST

*TM 9-6115-465-24P
TO-35C2-3-446-4
NAVFAC P-8-625-24P
SL-4-06858B/06859D

TECHNICAL MANUAL

UNIT, DIRECT SUPPORT, AND
GENERAL SUPPORT MAINTENANCE REPAIR PARTS AND
SPECIAL TOOLS LISTS (INCLUDING DEPOT MAINTENANCE
REPAIR PARTS AND SPECIAL TOOLS)

GENERATOR SET, DIESEL ENGINE DRIVEN, TACTICAL SKID MTD. 30 KW,
3 PHASE, 4 WIRE, 120/208 AND 240/416 VOLTS

<u>DOD MODEL</u>	<u>CLASS</u>	<u>HERTZ</u>	<u>NSN</u>
MEP-005A	UTILITY	50/60	6115-00-118-1240
MEP-104A	PRECISE	50/60	6115-00-118-1247
MEP-114A	PRECISE	400	6115-00-118-1248

INCLUDING OPTIONAL KITS

<u>DOD MODEL</u>	<u>NOMENCLATURE</u>	<u>NSN</u>
MEP-005-AWF	WINTERIZATION KIT, FUEL BURNING	6115-00-63-9083
MEP-005-AWE	WINTERIZATION KIT, ELECTRIC	6115-00-463-9085
MEP-002-ALM	LOAD BANK KIT	6115-00463-9088
MEP-005-AWM	WHEEL MOUNTING KIT	6115-00-463-9094

Approved for public release; distribution is unlimited.

*This manual supersedes TM 5-6115-465-24P/TO 35C2-3-446-4 / NAVFAC P-8-625-24P / SL-4-06858B/06859D, dated 15 January 1982, including all changes.

HEADQUARTERS, DEPARTMENTS OF THE ARMY, AIR FORCE, NAVY
AND HEADQUARTERS U.S. MARINE CORPS

3 JUNE 1992

CHANGE

HEADQUARTERS, DEPARTMENTS OF
 THE ARMY, AIR FORCE AND NAVY, AND
 HEADQUARTERS, US MARINE CORPS
 WASHINGTON, D.C., 30 November 1996

NO. 2

Unit, Direct Support, and General Support Maintenance
 Repair Parts and Special Tools Lists
 (Including Depot Maintenance Repair Parts and Special Tools)

**GENERATOR SET, DIESEL ENGINE DRIVEN,
 TACTICAL SKID MTD., 30 KW, 3 PHASE,
 4 WIRE, 120/208 AND 240/416 VOLTS**

<u>DOD MODEL</u>	<u>CLASS</u>	<u>HERTZ</u>	<u>NSN</u>
MEP-005A	UTILITY	50/60	6115-00-118-1240
MEP-104A	PRECISE	50/60	6115-00-118-1247
MEP-114A	PRECISE	400	6115-00-118-1248

INCLUDING OPTIONAL KITS

<u>DOD MODEL</u>	<u>NOMENCLATURE</u>	<u>NSN</u>
MEP-005-AWF	WINTERIZATION KIT, FUEL BURNING	6115-00-463-9083
MEP-005-AWE	WINTERIZATION KIT, ELECTRIC	6115-00-463-9085
MEP-002-ALM	LOAD BANK KIT	6115-00-463-9088
MEP-005-AWM	WHEEL MOUNTING KIT	6115-00-463-9094

DISTRIBUTION STATEMENT A: Approved for public release; distribution is unlimited

TM 9-6115-465-24P/TO 35C2-3-446-4/NAVFAC P-8-625-24P/SL-4-06858B/06859D, 3 June 1992, is changed as follows:

1. Remove and insert pages as indicated below. New or changed text material is indicated by a vertical bar in the margin. An illustration change is indicated by a miniature pointing hand.

Remove pages
 i and ii
 11 and 12
 15 and 16
 31 and 32
 159 and 160
 183 and 184
 187 and 188
 191 and 192
 199 and 200
 219 and 220

Insert pages
 i and ii
 11 and 12
 15 and 16
 31 and 32
 159 and 160
 183 and 184
 187 and 188
 191 and 192
 199 and 200
 219 and 220

TM 9-6115-465-24P
TO 35C2-3-446-4
NAVFAC P-8-625-24P
SL-4-06858B/06859D
C2

Remove pages
237 and 238
247 and 248
257 blank/258
277 and 278
281 and 282
383 through 390
393 and 394
397 and 398
405 through 408
413 and 414
417 and 418
421 and 422
425 through 428
433 and 434
439 through 442

Insert Pages
237 and 238
247 and 248
257 blank/258
277 and 278
281 and 282
383 through 390
393 and 394
397 and 398
405 through 408
413 and 414
417 and 418
421 and 422
425 through 428
433 and 434
439 through 442

2. Retain these sheets in front of manual for reference purposes.

TM 9-6115-465-24P
TO 35C2-3-446-4
NAVFAC P-8-625-24P
SL-4-06858B/06859D
C2

By Order of the Secretaries of the Army, Air Force, and Navy (Including the Marine Corps):

Official:

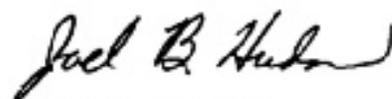

JOEL B. HUDSON
*Administrative Assistant to the
Secretary of the Army*
03090

DENNIS J. REIMER
*General, United States Army
Chief of Staff*

RONALD R. FOGELMAN
*General, USAF
Chief of Staff*

Official:

HENRY VICCELIO, JR.
*General, USAF
Commander, Air Force Material Command*

J. E. BUFFINGTON
*Rear Admiral, CEC, US Navy
Commander
Navy Facilities Engineering
Command*

M. K. HAYDEN
*Colonel, USMC
Director, Program Support
Marine Corps Systems Command*

DISTRIBUTION:

To be distributed in accordance with DA Form 12-25-E, block no. 5784, requirements for TM 9-6115 465-24P.

CHANGE

HEADQUARTERS, DEPARTMENTS OF
THE ARMY, NAVY AND THE AIR FORCE AND
HEADQUARTERS, U.S. MARINE CORPS
WASHINGTON, D. C., 30 DECEMBER 1992

NO. 1

Unit, Direct Support, and General Support Maintenance
Repair Parts and Special Tools Lists
(Including Depot Maintenance Repair Parts and Special Tools)

**GENERATOR SET, DIESEL ENGINE DRIVEN,
TACTICAL SKID MTD., 30 KW, 3 PHASE,
4 WIRE, 120/208 AND 240/416 VOLTS**

DOD MODEL	CLASS	HERTZ	NSN
MEP-005A	UTILITY	50/60	6115-00-118-1240
MEP-104A	PRECISE	50/60	6115-00-118-1247
MEP-114A	PRECISE	4 0 0	6115-00-118-1248

INCLUDING OPTIONAL KITS

<u>DOD MODEL</u>	<u>NOMENCLATURE</u>	<u>NSN</u>
MEP-005-AWF	WINTERIZATION KIT, FUEL BURNING	6115-00-463-9083
MEP-005-AWE	WINTERIZATION KIT, ELECTRIC	6115-00-463-9085
MEP-002-ALM	LOAD BANK KIT	6115-00-463-9088
MEP-005-AWM	WHEEL MOUNTING KIT	6115-00-463-9094

DISTRIBUTION STATEMENT A: Approved for public release; distribution is unlimited

TM 9-6115-465-24P/TO 35C2-3-446-4/NAVFAC P-8-625-24P/SL-4-06858B/06859D, 3 June 1992, is changed as follows:

1. Remove and insert pages as indicated below. New or changed text material is indicated by a vertical bar in the margin. An illustration change is indicated by a miniature pointing hand.

Remove pages

Insert pages

5 through 7/(8 blank)

5 through 7/(8 blank)

2. Retain this sheet in front of manual for reference purposes.

TM9-6115-465-24P
TO 35C2-3-446-4
NAVFACP-8-625-24P
SL-4-06858B/06859D
C1

By Order of the Secretaries of the Army, Air Force, and Navy:

Official:



MILTON H. HAMILTON
*Administrative Assistant to the
Secretary of the Army*
04015

GORDON R. SULLIVAN
*General, United States Army
Chief of Staff*

MERRILL A. McPEAK
*General, USAF
Chief of Staff*

Official:

RONALD W. YATES
*General, USAF
Commander Air Force Materiel Command*

DAVID E. BOTTORFF
*Rear Admiral, CEC, US Navy
Commander
Navy Facilities Engineering
Command*

RONALD D. ELLIOTT
*Executive Director
Marine Corps Systems Command*

DISTRIBUTION:

To be distributed in accordance with DA Form 12-25-E, block no. 5784, requirements for TM 9-6115-465-24P.

ARMY TECHNICAL MANUAL
AIR FORCE TECHNICAL ORDER
NAVY PUBLICATION
MARINE CORPS STOCK LIST

*TM 9-6115-465-24P
TO 35C2-3-446-4
NAVFAC P-8-625-24P
SL-4-06858B/06859D

TECHNICAL MANUAL

HEADQUARTERS, DEPARTMENTS OF
THE ARMY, AIR FORCE, AND NAVY, AND
HEADQUARTERS, US MARINE CORPS
WASHINGTON, D.C., 3 June 1992

NO. 9-6115-465-24P

TECHNICAL MANUAL

UNIT, DIRECT SUPPORT, AND GENERAL SUPPORT MAINTENANCE
REPAIR PARTS AND SPECIAL TOOLS LIST
(INCLUDING DEPOT MAINTENANCE REPAIR PARTS AND SPECIAL TOOLS)

**GENERATOR SET, DIESEL ENGINE DRIVEN,
TACTICAL SKID MTD. 30 KW, 3 PHASE,
4 WIRE, 120/208 AND 240/416 VOLTS**

<u>DOD MODEL</u>	<u>CLASS</u>	<u>HERTZ</u>	<u>NSN</u>
MEP-005A	UTILITY	50/50	6115-00-118-1240
MEP-104A	PRECISE	50/60	6115-00-118-1247
MEP-114A	PRECISE	400	6115-00-118-1248

INCLUDING OPTIONAL KITS

<u>DOD MODEL</u>	<u>NOMENCLATURE</u>	<u>NSN</u>
MEP-005-AWF	WINTERIZATION KIT, FUEL BURNING	6115-00-463-9083
MEP-005-AWE	WINTERIZATION KIT, ELECTRIC	6115-00-463-9085
MEP-002-ALM	LOAD BANK KIT	6115-00-463-9088
MEP-005-AWM	WHEEL MOUNTING KIT	6115-00-463-9094

Current as of 22 May 1991

REPORTING ERRORS AND RECOMMENDING IMPROVEMENTS

You can help improve this manual. If you find any mistakes, or if you know of a way to improve these procedures, please let us know. Mail your letter or DA Form 2028 (Recommended Changes to Publications and Blank Forms), or DA Form 2028-2 located in the back of this manual directly to: Commander, US Army Aviation and Troop Command, ATTN: AMSAT-I-MP, 4300 Goodfellow Blvd., St. Louis, MO 63120-1798. You may also submit your recommended changes by E-mail directly to <mpmt%avma28@st-louis-emh7.army.mil>. A reply will be furnished directly to you. Instructions for sending an electronic 2028 may be found at the back of this manual immediately preceding the hard copy 2028.

DISTRIBUTION STATEMENT A: Approved for public release; distribution is unlimited.

*This manual supersedes TM 5-6115-465-24P/TO 35C2-3-446-4/NAVFAC P-8-625-24P/SL-4-06858B/06859D, dated 15 January 1982, including all changes

Change 2 i

TABLE OF CONTENTS

	Figure	Page
Section I	INTRODUCTION	1
II	REPAIR PARTS LIST	11
Group 01	Batteries and Related Items	
	Batteries and related items	1 11
02	Exhaust and Breather Pipes	
	Exhaust pipe, muffler and breathertube	2 15
03	Convenience Receptacles	
	Convenience Receptacles	3 17
04	Convenience Receptacles 400Hz	
	Paralleling and convenience receptacles	4 19
05	Plate and Sleeve Assembly	
	Plate and sleeve	5 21
06	Paralleling Receptacles	
	Shorting plug	6 23
07	Generator Set Controls	
	Fault locating indicator and D.C. circuit breaker	7 25
	Control cubicle assembly and manual speed control	8 31
	Control cubicle branched wiring harness	9 39
	AC power control wiring harness	10 41
	Fault locating indicator to special relay wiring harness	11 43
	RFI capacitors wiring harness	12 45
08	Housing Group	
	Housing assembly	13 47
	Cord and wrench assembly	14 55
09	Wiring Harness	
	Engine wiring harness	15 57
	Electric governor system wiring harness	16 61
	Governor control unit to hydraulic actuator unit wiring harness	17 63
10	Load Connection Group	
	Main load contactor	18 69
	Main load contactor HB 200A	19 77
	Reconnection board to contactor wiring harness	20 83
	Reconnection board	21 85
11	Governor Control Unit	
	Governor control unit	22 91
	Electric governor control unit	23 99
12	Air Cleaner Assembly	
	Air cleaner	24 101
13	Relay Table Group	
	Tactical relay	25 105
	Tactical relay to special relay wiring harness	26 109
	Special relay	27 113
	Special relay to precise relay wiring harness	28 119
	Special relay to static exciter wiring harness	29 121

TABLE OF CONTENTS (Continued)

	Figure	Page
13	Relay Table Group (Continued)	
	Special relay to control cubicle wiring harness	30 123
	Precise relay	31 127
	Precise relay to governor control unit wiring harness	32 132
	Static exciter and voltage regulator	33 137
	Exciter control wiring harness	34 147
	Load measuring unit	35 149
	Load measuring unit to tactical relay assembly wiring harness	36 153
	Relay tables	37 155
14	Generator Assembly	
	Generator assembly	38 159
	Blower and coupling disc	39 163
	Bearing assembly	40 165
	Lead block assembly	41 167
	Bracket assembly.	42 169
	50/60 Hz stator assembly	43 171
	400 H, stator assembly	44 173
	50/60 Hz rotor assembly	45 175
	400 Hz rotor assembly	46 179
15	Day Tank and Fuel Filter Assembly	
	Day tank and ether starting aid	47 183
	Primary fuel filter and strainer	48 187
	Secondary fuel filter	49 191
16	CenterSupport	
	Center support and fuel pumps	50 193
17	Cooling Group	
	Radiator and shutter assembly	51 197
	Vanguards	52 203
18	Hydraulic Actuator	
	Hydraulic actuator unit	53 205
	Actuator electric governor	54 211
19	Hydraulic Sump and Filter	
	Hydraulic lines and fittings	55 213
	Hydraulic sump and filter	56 217
20	Engine Assembly	
	Alternator , Battery Charging	57 219
	Battery charging alternator	58 223
	Hydraulic pump	59 227
	Plate cover take off hydraulic pump	60 231
	Speed switch	61 233
	Speed switch	62 235
	Oil filter and sensors	63 237
	Starter assembly	64 241
	Fuel injection lines and fittings	65 247
	Fuel injector assembly	66 251
	Fuel injection pump governor	67 253
	Fuel injection pump linkage and control	68 255

TABLE OF CONTENTS (Continued)

	Figure	Page
20	Engine Assembly (Continued)	
	Fuel injection pump end plate and blades	69 259
	Fuel injection pump, pivot shaft and arm assembly	70 261
	Fuel injection pump piston and damper spring	71 265
	Fuel injection pump rotor assembly	72 267
	Fuel injection pump housing and drive shaft	73 271
	Fan and water pump assembly	74 273
	Coolant thermostat and sensors	75 277
	Intake and exhaust manifolds	76 279
	Cylinder head, cover, and valve operating mechanism	77 281
	Oil pan and oil pump	78 285
	Flywheel, ring gear and housing	79 289
	Gear case and timing gears	80 291
	Piston, connecting rod, crankshaft and support	81 295
	Camshaft, timing tear and bearings	82 299
	Cylinder block	83 301
21	Base Group	
	Fuel tank and skid base	84 305
	Fuel lines and fittings	85 309
	Fuel vent lines	86 313
22	Accessory Items	
	Accessory items.	87 317
23	Parts Kits	320
25	Winterization Kit, Fuel Burning	
	Fuel burning winterization kit	88 323
	Engine heater control box	89 327
	Engine heater.	90 329
	Fuel burning winterization kit wiring harness	91 335
26	Winterization Kit, Electric	
	Electric winterization kit	92 337
	Electric heater control box	93 341
	Electric heater control box wiring harness	94 345
	Electric winterization kit wiring harness	95 347
	Control box to special relay box wiring harness	96 349
27	Kit-Wheel Mounting	
	Wheel mounting kit	97 351
28	Load Bank	
	Load bank kit	98 357
	Load bank control box	99 361
	Load bank power wiring harness	100 365
	Load bank signal wiring harness	101 367
	Control box wiring harness	102 369
	Control box wiring harness	103 371
	Control box branched wiring harness	104 373
	Bottom load bank wiring harness	105 375
	Load bank wiring harness	106 377
	Top load bank wiring harness	107 379
Section III	SPECIAL TOOLS LIST (Not Applicable)	
IV	NATIONAL STOCK NUMBER AND REFERENCE	
	NUMBER INDEX	383

UNIT, DIRECT SUPPORT AND GENERAL SUPPORT MAINTENANCE REPAIR PARTS AND SPECIAL TOOLS LIST

SECTION I. INTRODUCTION

1. SCOPE. This RPSTL lists and authorizes spares and repair parts; special tools; special test, measurement, and diagnostic equipment (TMDE); and other special support equipment required for performance of unit, direct support, and general support maintenance of the Generator Set, Diesel Engine Driven, Tactical Skid Mounted. It authorizes the requisitioning, issue, and disposition of spares, repair parts and special tools as indicated by the source, maintenance and recoverability (SMR) codes.

2. GENERAL. In addition to this section, Introduction, this Repair Parts and Special Tools List is divided into the following sections:

a. Section II. Repair Parts List. A list of spares and repair parts authorized by this RPSTL for use in the performance of maintenance. The list also includes parts which must be removed for replacement of the authorized parts. Parts lists are composed of functional groups in ascending alphanumeric sequence, with the parts in each group listed in ascending figure and item number sequence. Bulk materials are listed in item name sequence. Repair parts kits are listed separately in their own functional group within Section II. Repair parts for repairable special tools are also listed in this section. Items listed are shown on the associated illustration(s)/figure(s).

b. Section III. Special Tools List. A list of special tools, special TMDE, and other special support equipment authorized by this RPSTL (as indicated by Basis of Issue (BOI) information in DESCRIPTION AND USABLE ON CODE column) for the performance of maintenance.

c. Section IV. Cross-references Indexes. A list, in National Item Identification Number (NIIN) sequence, of all National stock numbered items appearing in the listing, followed by a list in alphanumeric sequence of all part numbers appearing in the listings. National stock numbers and part numbers are cross referenced to each illustration figure and item number appearance. The figure and item number index lists figure and item number in alphanumeric sequence and cross references NSN, CAGEC and part number.

3. EXPLANATION OF COLUMNS (SECTIONS II AND III).

a. ITEM NO. (Column (1)). Indicates the number used to identify items called out in the illustration.

b. SMR Code (Column (2)). The Source, Maintenance, and Recoverability (SMR) code is a 5-position code containing supply/requisitioning information, maintenance category authorization criteria, and disposition instruction, as shown in the following breakout:

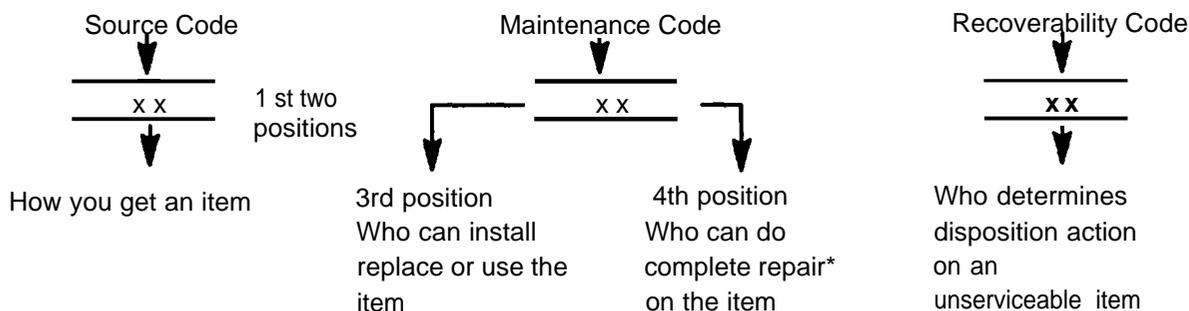

* Complete Repair: Maintenance capacity, capability, and authority to perform all corrective maintenance tasks of the "Repair" function in a use/user environment in order to restore serviceability to a failed item.

(1) Source Code. The source code tells you how to get an item needed for maintenance, repair, or overhaul of an end item/equipment. Explanations of source codes follows:

Code	Explanation
PA PB PC** PD PE PF PG	<p>Stocked items; use the applicable NSN to requested/requisition items with these source codes. They are authorized to the category indicated by the code entered in the 3rd position of the SMR code.</p> <p>**NOTE: Items coded PC are subject to deterioration.</p>
KD KF KB	<p>Items with these codes are not to be requested/requisitioned individually. They are part of a kit which is authorized to the maintenance category indicated in the 3rd position of the SMR code. The complete kit must be requisitioned and applied.</p>
MO - (Made at org AVUM Level) MF - (Made at DS/AVUM Level) MH - (Made at GS Level) ML - (Made at Specialized Repair Activity (SRA)) MD - (Made at Depot)	<p>Items with these codes are not to be requested/requisitioned individually. They must be made from bulk material which is identified by the part number in the DESCRIPTION and USABLE ON CODE (UOC) column and listed in the Bulk Material group of the repair parts list in this RPSTL. If the item is authorized to you by the 3rd position code of the SMR code, but the source code indicates it is made at a higher level, order the item from the higher level of maintenance.</p>
AO - (Assembled by org/AVUM Level) AF - (Assembled by DS/AVIM Level) AH - (Assembled by GS Category) AL - (Assembled by SRA) AD - (Assembled by Depot)	<p>Items with these codes are not to be requested/requisitioned individually. The parts that make up the assembled item must be requisitioned or fabricated and assembled at the level of maintenance indicated by the source code. If the 3rd position code of the SMR code authorizes you to replace the item, but the source code indicates the items are assembled at a higher level, order the item from the higher level of maintenance.</p>
XA —	Do not requisition "XA" -coded item. Order its next higher assembly. (Also, refer to the NOTE below.)
XB —	If an "XB" item is not available from salvage, order it using the CAGEC and part number given.
XC —	Installation drawing, diagram, instruction sheet, field service drawing, that is identified by Reciprocating Compressor manufacturer's part number.
XD —	Item is not stocked. Order an "XD" -coded item through normal supply channels using the CAGEC and part number given if no NSN is available.

NOTE

Cannibalization or controlled exchange, when authorized, may be used as a source of supply for items with the above source codes, except for those source coded "XA" or those aircraft support items restricted by requirements of AR 750-1.

(2) Maintenance Code. Maintenance codes tells you the level(s) of maintenance authorized to USE and REPAIR support items. The maintenance codes are entered in the third and fourth positions of the SMR code as follows:

(a) The maintenance code entered in the third position tells you the lowest maintenance level authorized to remove, replace, and use an item. The maintenance code entered in the third position will indicate authorization to one of the following levels of maintenance.

Code	Application/Explanation
C	— Crew or operator maintenance done within organizational or aviation unit maintenance.
O	— Organizational or aviation unit category can remove, replace, and use the item.
F	— Direct support or aviation intermediate level can remove, replace, and use the item.
H	— General support level can remove, replace, and use the item.
L	— Specialized repair activity can remove, replace, and use the item.
D	— Depot level can remove, replace, and use the item.

(b) The maintenance code entered in the fourth position tells whether or not the item is to be repaired and identifies the lowest maintenance level with the capability to do complete repair (i.e., perform all authorized repair functions.) NOTE: Some limited repair may be done on the item at a lower level of maintenance, if authorized by the Maintenance Allocation Chart (MAC) and SMR codes. This position will contain one of the following maintenance codes.

Code	Application/Explanation
O	— Organizational or (aviation unit) is the lowest level that can do complete repair of the item.
F	— Direct support or aviation intermediate is the lowest level that can do complete repair of the item.
H	— General Support is the lowest level that can do complete repair of the item.
L	— Specialized repair activity is the lowest level that can do complete repair of the item.
D	— Depot is the lowest level that can do complete repair of the item.
Z	— Nonreparable. No repair is authorized.
B	— No repair is authorized. (No parts or special tools are authorized for the maintenance of a "B" coded item). However, the item may be reconditioned by adjusting, lubricating, etc., at the user level.

(3) Recoverability Code. Recoverability codes are assigned to items to indicate the disposition action on unserviceable items. The recoverability code is entered in the fifth position of the SMR Code as follows:

Recoverability

Codes

Application/Explanation

- Z — Nonreparable item. When unserviceable, condemn and dispose of the item at the level of maintenance shown in 3d position of SMR Code.
- O — Reparable item. When not economically reparable, condemn and dispose of the item at organizational or aviation unit level
- F — Reparable item. When uneconomically reparable, condemn and dispose of the item at the direct support or aviation intermediate level
- H — Reparable item. When uneconomically reparable, condemn and dispose of the item at the general support level.
- D — Reparable item. When beyond lower level repair capability, return to depot. Condemnation and disposal of item not authorized below depot level.
- L — Reparable item. Condemnation and disposal not authorized below specialized repair activity (SRA).
- A — Item requires special handling or condemnation procedures because of specific reasons (e.g., precious metal content, high dollar value, critical material, or hazardous material) . Refer to appropriate manuals/directives for specific instructions.

c. CAGEC (Column (3)). The Commercial and Government Entity Code (CAGEC) is a 5-digit numeric code which is used to identify the manufacturer, distributor, or Government agency, etc., that supplies the item.

d. PART NUMBER (Column (4)). Indicates the primary number used by the manufacturer, (individual, company, firm, corporation, or Government activity), which controls the design and characteristics of the item by means of its engineering drawings, specifications standards, and inspection requirements to identify an item or range of items,

NOTE

When you use an NSN to requisition an item, the item you receive may have a different part number from the part ordered.

e. DESCRIPTION AND USABLE ON CODE (UOC) (Column (5)). This column includes the following information:

- (1) The Federal item name and, when required, a minimum description to identify the item.
- (2) The physical security classification of the item is indicated by the parenthetical entry, e.g., PhySec C1 - Confidential, Phy Sec C1 (S) - Secret, Phy Sec C1 (T) – Top Secret.
- (3) items that are included in kits and sets are listed below the name of the kit or set.
- (4) Spare/repair parts that make up an assembled item are listed immediately following the assembled item line entry.
- (5) Part numbers for bulk materials are referenced in this column in the line item entry for the item to be manufactured/fabricated.
- (6) When the item is not used with all serial numbers of the same model, the effective serial numbers are shown on the last line(s) of the description (before UOC).

(7) The usable on code, when applicable (see paragraph 5, Special Information).

(8) In the Special Tools List section, the basis of issue (B01) appears as the last line(s) in the entry *for* each special tool, special TMDE, and other special support equipment. When density of equipments supported exceeds density spread indicated in the basis of issue, the total authorization is increased proportionately.

(9) The statement "END OF FIGURE" appears just below the last item description in Column 5 for a given figure in both Section II and Section III.

(10) The indenture, shown as dots appearing before the repair part, indicates that the item is a repair part of the next higher assembly.

f. QTY (Column 6). The QTY (quantity per figure column) indicates the quantity of the item used in the breakout shown on the illustration figure, which is prepared for a functional group, subfunctional group, or an assembly. A "V" appearing in this column in lieu of a quantity indicates that the quantity is variable and may vary from application to application.

4. EXPLANATION OF COLUMNS (SECTION IV).

a. NATIONAL STOCK NUMBER (NSN) INDEX.

(1) **STOCK NUMBER** column. This column lists the NSN by National item identification number (NIIN) sequence. The NIIN consists of the last nine digits of the NSN, i.e.

NSN
<u>5305-01-574-1467</u>
NIIN

When using this column to locate an item, ignore the first 4 digits of the NSN. However, the complete NSN should be used when ordering items by stock number.

(2) **FIG.** column. This column lists the number of the figure where the item is identified/located. The figures are in numerical order in Section II and Section III.

(3) **ITEM** column. The item number identifies the item associated with the figure listed in the adjacent FIG. column. This item is also identified by the NSN listed on the same line.

b. PART NUMBER INDEX. Part numbers in this index are listed by part number in ascending alphanumeric sequence (i.e., vertical arrangement of letter and number combination which places the first letter or digit of each group in order A through Z, followed by the numbers 0 through 9 and each following letter or digit in like order).

(1) **CAGEC** column. The Commercial and Government Entity Code (CAGEC) is a 5-digit numeric code used to identify the manufacturer, distributor, or Government agency, etc., that supplies the item.

(2) **PART NUMBER** column. Indicates the primary number used by the manufacturer (individual, firm, corporation, or Government activity), which controls the design and characteristics of the item by means of its engineering drawings, specifications standards, and inspection requirements to identify an item or range of items.

(3) **STOCK NUMBER** column. This column lists the NSN for the associated part number and manufacturer identified in the PART NUMBER and CAGEC columns to the left.

(4) **FIG. column.** This column lists the number of the figure where the item is identified/located in Sections II and III.

(5) **ITEM column.** The item number is that number assigned to the item as it appears in the figure referenced in adjacent figure number column.

c. FIGURE AND ITEM NUMBER INDEX.

(1) **FIG, column.** This column lists the number of the figure where the item is identified located in Section II and III.

(2) **ITEM column.** The item number is that number assigned to the item as it appears in the figure referenced in the adjacent figure number column.

(3) **STOCK NUMBER column.** This column lists the NSN for the item.

(4) **CAGEC column.** The Commercial and Government Entity Code (CAGEC) is a 5-digit numeric code used to identify the manufacturer, distributor, or Government agency, etc., that supplies the item.

(5) **PART NUMBER column.** Indicates the primary number used by the manufacturer (individual, firm, corporation, or Government activity), which controls the design and characteristics of the item by means of its engineering drawings, specifications standards, and inspection requirements to identify an item or range of items.

5. SPECIAL INFORMATION

a. USABLE ON CODE. The usable on code appears in the lower corner of the Description column heading. Usable on codes are shown as "UOC:.." in the Description Column justified right on the last line of the applicable item description /nomenclature. Uncoded items are applicable to all models.

Code	Used On
CLA	MEP-005A
CLB	MEP-104A
CLC	MEP-114A
CZN	MEP-005A (Serial Nos. KZ00001 thru KZ02752)
CZM	MEP-104A (Serial Nos. KZ00001 thru KZ02752)
DGG	MEP-114A (Serial No. RZ70001 and sub.)

b. ASSOCIATED PUBLICATIONS. The publications listed below pertains to the Generator Set Diesel Engine Driven, Tactical Skid Mounted and its components.

Publication	Short Title
TM 9-6115-465-24	Generator Set, Diesel Engine Driven, Tactical Skid Mounted
TO 52C2-3-446-4	
NAVFAC P-8-625-24	
SL-4-06858B/06859D	

c. (ARMY) Repair Parts Mortality has been based on 5000 hours operation per year.

d. (ARMY) The basis of issue for authorized tools, test, and support equipment is the number of end items of equipment supported and the number of maintenance personnel allocated to perform the required maintenance operations as follows:
 (such as, soldering iron per five MOS284.1 supporting 1-15 Radio Set AN/ARC-51).

e. (ARMY) Parts which require manufacture of assembly at a category higher than that authorized for installation will indicate in the source column, the higher category.

f. STOCKAGE INFORMATION.

(1) **Air Force Stockage** information is contained in initial Supply Support Lists issued separately from this publication by SMAMA in accordance with ARM-67-1, part 1, Chapter 12.

(2) **Navy Stockage** objectives are contained in Consolidated Shipboard Allowance list as furnished separately from the publication by the Ship Parts Control Center.

(3) **Marine Corps** Stockage information is contained in Block 3a. of this manual.

6. HOW TO LOCATE REPAIR PARTS.

a. WHEN NATIONAL STOCK NUMBER OR PART NUMBER IS NOT KNOWN.

(1) **First.** Using the table of contents, determine the assembly group or subassembly group to which the item belongs. This is necessary since figures are prepared for assembly groups and subassembly groups, and listings are divided into the same groups.

(2) **Second.** Find the figure covering the assembly group or subassembly group to which the item belongs.

(3) **Third.** Identify the item on the figure and note the item number.

(4) **Fourth.** Refer to the Repair Parts List for the figure to find the part number for the item number noted on the figure.

(5) **Fifth.** Refer to the Part Number Index to find the NSN, if assigned.

b. WHEN NATIONAL STOCK NUMBER OR PART NUMBER IS KNOWN.

(1) **First.** Using the Index of National Stock Numbers and Part Numbers, find the pertinent National Stock Number or Part Number. The NSN index is in National Item Identification Number (NIIN) sequence (see paragraph 4a.(1)). The part numbers in the Part Number index are listed in ascending alphanumeric sequence (see paragraph 4.b). Both indexes cross-reference you to the illustration figure and item number of the item you are looking for.

(2) **Second.** After finding the figure and item number, verify that the item is the one you are looking for, then locate the item number in the repair parts list for the figure.

7. ABBREVIATIONS. Abbreviations used in this manual are listed in MIL-STD-12.

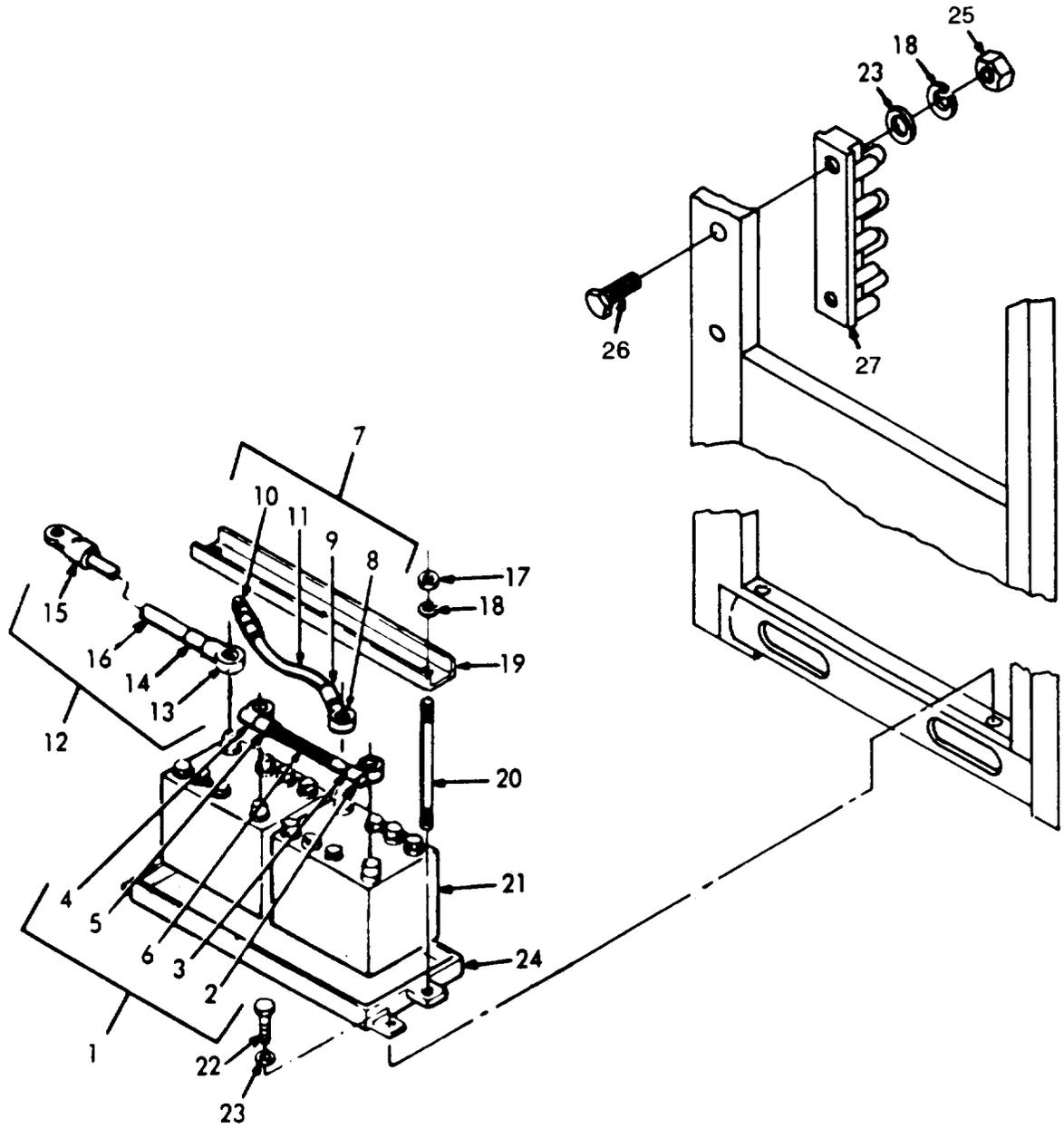

Figure 1. Batteries and related items. (sheet 1 of 2).

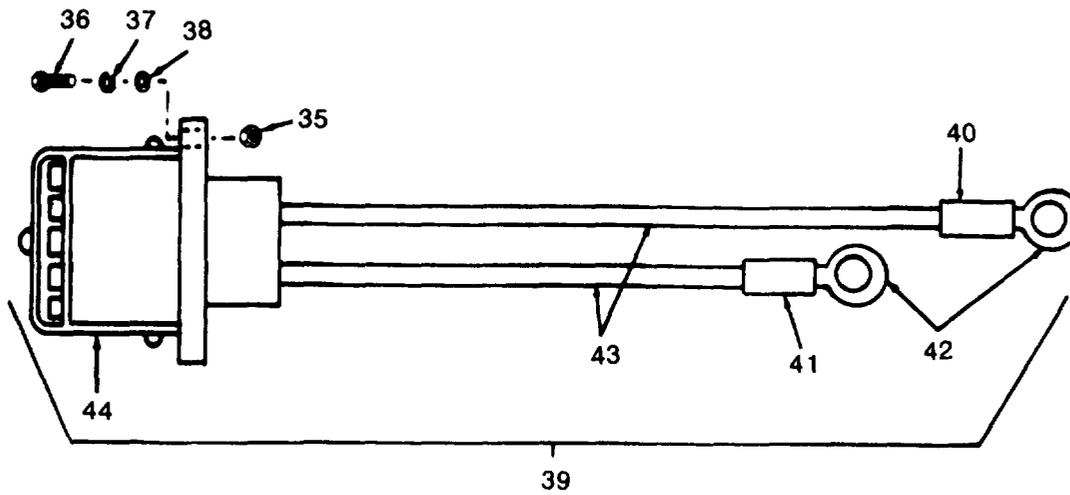
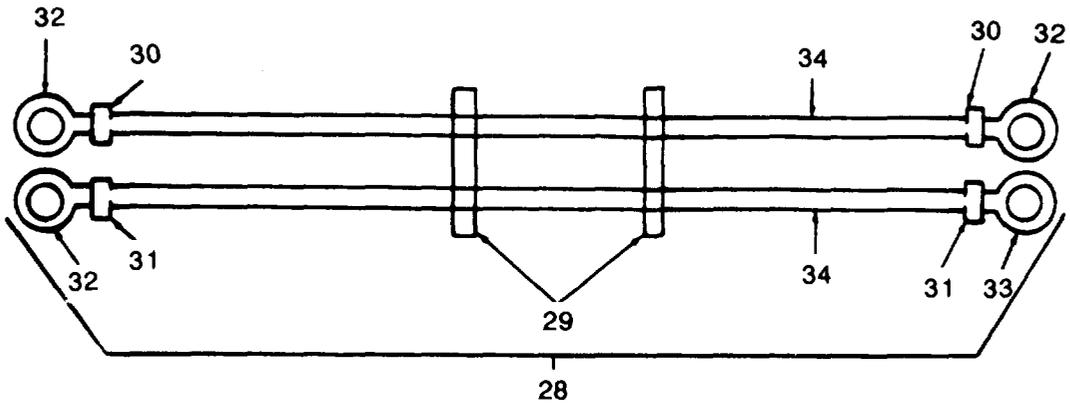

Figure 1. Batteries and related items. (sheet 2 of 2)

(1) ILLUSTRATION A B FIG. ITEM NO. NO.		(2) SMR CODE A B C D ARMY AIR NAVY USMC				(3) A SSI	(4) NATIONAL STOCK NUMBER B REPL FACTOR	(5) DESCRIPTION REF NUMBER & MFR CODE	(6) USABLE ON CODE U/M	(7) QTY INC IN UNITS	(8) USMC QTY PER EQUIP	
SECTION II-REPAIR PARTS LIST												
GROUP 01-BATTERIES AND RELATED ITEMS												
1	1	MOOZZ	MOO	PAGZZ	MOOZZ		6140-01-010-1272	CABLE, BATTERY: JUMPER 72-2281-1 30554 30554-72-2281-1 36024	EA	1	1	
1	2	PAOZZ	PAOZZ	XBGZZ	PAOZZ	D	.005	5940-00-549-6583	TERMINAL, BATTERY MS75004-2 96906	EA	1	2
1	3	PAOZZ	PAOZZ	PAGZZ	PAOZZ	D	.008	5970-00-914-3117	SLEEVING, INSULATION, RED M23053/5-109-2 81349	FT	V	V
1	4	PAOZZ	PAOZZ	XBGZZ	PAOZZ	D	.005	5940-00-549-6581	TERMINAL, BATTERY MS75004-1 96906	EA	1	2
1	5	PAOZZ	PAOZZ	PAGZZ	PAOZZ	D	.008	5970-00-914-3118	SLEEVING, INSULATION, BLACK M23053/5-109-0 81349	FT	V	V
1	6	PAOZZ	PAOZZ	PAGZZ	PAOZZ	D	.020	6145-00-805-3354	CABLE, ELECTRICAL, AS REQUIRED M134861-12 81349	FT	V	14
1	7	MOOZZ	MOO	PAGZZ	MOOZZ			6140-01-010-1273	CABLE, BATTERY 72-2281-2 30554 30554-72-2281-2 36024	EA	1	1
1	8	PAOZZ	PAOZZ	XBGZZ	PAOZZ	D	.005	5940-00-115-0776	LUG, TERMINAL MS20659-114 96906	EA	1	4
1	9	PAOZZ	PAOZZ	XBGZZ	PAOZZ	D	.008	5970-00-914-3118	SLEEVING, INSULATION, BLACK M23053/5-109-0 81349	FT	V	V
1	10	PAOZZ	PAOZZ	XBGZZ	PAOZZ	D	.005	5940-00-549-6581	TERMINAL, BATTERY MS75004-1 96906	EA	1	2
1	11	PAOZZ	PAOZZ	PAGZZ	PAOZZ	D	.020	6145-00-805-3354	CABLE, ELECTRICAL M13486-1-12 81349	FT	V	14
1	12	MOOZZ	MOO	PAGZZ	MOOZZ			6140-01-010-4079	CABLE BATTERY 72-2281-3 30554 30554-72-2281-3 36024	EA	1	1
1	13	PAOZZ	PAOZZ	XBGZZ	PAOZZ		.005	5940-00-549-6583	TERMINAL, BATTERY MS75004-2 96906	EA	1	2
1	14	PAOZZ	PAOZZ	XBGZZ	PAOZZ		.008	5970-00-914-3117	SLEEVING, INSULATION, RED M23053/5-109-2 81349	FT	V	V
1	15	PAOZZ	PAOZZ	XBGZZ	PAOZZ	D	.050	5940-00-115-0776	LUG, TERMINAL MS20659-114 96906	EA	1	4
1	16	PAOZZ	PAOZZ	PAGZZ	PAOZZ	D	.020	6145-00-805-3354	CABLE, ELECTRICAL M13486-1-12 81349	FT	V	14
1	17	PAOZZ	PAOZZ	PAOZZ	PAOZZ	D	.008	5310-00-732-0558	NUT, PLAIN HEXAGON: BATTERY RETAINER MTG MS51967-8 96906	EA	3	24
1	18	PAOZZ	PAOZZ	PAOZZ	PAOZZ	D	.010	5310-00-637-9541	WASHER, LOCK: BATTERY RETAINER MTG MS35338-46 96906	EA	5	104
1	19	XBOZZ	MFOZZ	XBOZZ	XBOZZ				RETAINER, BATTERY HOLDOWN 72-2090 30554 30554-72-2090-1 30624	EA	1	1

TM 9-6115-465-24P
TO 35C2-3-446-4
NAVFAC P-8-625-24P
SL-4-06858B/06859D

(1) ILLUS- TRATION		(2) SMR CODE				(3)		(4)	(5) DESCRIPTION		(6)	(7)	(8)
a	b	a	b	c	d	a	b	NATIONAL STOCK NUMBER	USABLE ON CODE	U/M	QTY INC IN UNIT	USMC QTY PER EQUIP	
FIG NO.	ITEM NO.	ARMY	AIR FORCE	NAVY	USMC	SSI	REPL FACTOR						REF NUMBER & MFR CODE
1	20	XBOZZ	MFFBZ	XBGZZ	XBOZZ	-	-				EA	3	3
									72-2067-1 30554 305546722067-1 30624				
1	21	PAGZZ	PAOZZ	PAHZZ	PAOZZ	-	.570	6140-01-210-1964	BATTERY, STORAGE MS52149-1 96906		EA	2	2
1	22	PAOZZ	PAOZZ	PAOZZ	PAOZZ	D	.008	5305-01-010-2362	SCREW, CAP, HEXAGON HEAD TRAY MTG MS18154-59 96906		EA	3	7
1	23	PAOZZ	PAOZZ	PAOZZ	PAOZZ	D	.010	5310-00-080-6004	WASHER, FLAT: BATTERY RETAINER MTG MS27183-14 96906		EA	5	18
1	24	XBOZZ	PBOBZ	XBGZZ	PAOZZ	-	-	6115-00-611-8018	TRAY, BATTERY RETAINER 72-2031 30554 30554-72-2031 36024		EA	1	1
1	25	PAOZZ	PAOZZ		PAOZZ	D	.008	5310 00-934-9747	NUT, PLAIN, HEXAGON MS35649-262 96906		EA	2	76
1	26	PAOZZ	PAOZZ		PAFZZ	D	.010	5305-00-036-6968	SCREW, WASHER ASSEMBLED 69-662-18 30554 P15121-18 45722		EA	2	67
1	27	PAFZZ	PAOZZ		PAFZZ	D	.005	5940-00-950-7781	TERMINAL BOARD MS27212-5-8 96906		EA	1	1
1	28	MOOZZ	MOOZZ	XBGZZ	MOOZZ	-	-	6115-01-024-5849	LEAD, ELECTRICAL 72-2291-2 30554 30554-72-2291-2 36024		EA	1	1
1	29	PAOZZ	PAOZZ	PAGZZ	PAOZZ	D	.008	5975-00-111-3206	STRAP, CABLE MS3367-5-9 96906		EA	V	V
1	30	PAOZZ	PAOZZ	XBGZZ	PAOZZ	D	.008	5970-00-914-3117	SLEEVING, INSULATION, RED M23053/5-109-2 81349		FT	V	
1	31	PAOZZ	PAOZZ	XBGZZ	PAOZZ	D	.008	5970-00-914-3118	SLEEVING, INSULATION, BLACK M23053/5-109-0 81349		FT	V	
1	32	PAOZZ	PAOZZ	XBGZZ	PAOZZ	D	.050	5949-00-115-0776	TERMINAL, LUG MS20659-114 96906		EA	3	7
1	33	PAOZZ	PAOZZ	XBGZZ	PAOZZ	D	.050	5940-00-606-4967	TERMINAL, RING 72-2044 30554 G376-58 98410		EA	1	1
1	34	PAOZZ	PAOZZ	XBGZZ	PAOZZ	D	.020	6145-00-805-3354	CABLE, ELECTRICAL M134866-1-12 81349		FT	V	
1	35	PAOZZ	PAOZZ	PAOZZ	PAFZZ	D	.008	5310-00-761-6882	NUT, PLAIN, HEXAGON: RECEPTACLE MTG MS51967-2 96906		EA	4	109
1	36	PAOZZ	PAOZZ	PAOZZ	PAFZZ	D	.008	5305-00-068-0502	SCREW, CAP, HEXAGON HEAD: RECEPTACLE MTG MS90725-6 96906		EA	4	56
1	37	PAOZZ	PAOZZ	PAOZZ	PAFZZ	0	.010	5310-00-582-5965	WASHER, LOCK: RECEPTACLE MTG MS35338 96906		EA	4	258
1	38	PAOZZ	PAOZZ	PAOZZ	PAFZZ	D	.010	5310-00-823-8804	WASHER, FLAT: RECEPTACLE MTG MS27183-99 96906		EA	4	45
1	39	MOOZZ	AFO	AGGGG	PAFZZ	-	-	5935-01-203-0990	RECEPTACLE ASSEMBLY 72-2280 30554 30554-72-2280 36024		EA	1	1
1	40	PAOZZ	PAOZZ	XBGZZ	PAFZZ	D	.008	5970-00-914-3117	SLEEVING INSULATION, RED M2053/5-109-2 81349		FT	V	

TM9-6115-465-24P
 TO 35C2-3-446-4
 NAVFAC P-8-625-24P
 SL-4-06858B/06859D

(1) ILLUSTRATION		(2) SMR CODE				(3)		(4) NATIONAL STOCK NUMBER	(5) DESCRIPTION	(6) USABLE ON CODE	(7) QTY INC IN UNITS	(8) USMC QTY PER EQUIP
A FIG. NO.	B ITEM NO.	A ARMY	B AIR FORCE	C NAVY	D USMC	A SSI	B REPL FACTOR	REF NUMBER & MFR CODE	U/M			
1	41	PAOZZ	PAOZZ	XBGZZ	PAFZZ	D	.008	5970-00-914-3118 SLEEVING, INSULATION, BLACK M2053/5-109-0 81349	FT	V		
1	42	PAOZZ	PAOZZ	XBGZZ	PAFZZ	D	.050	5949-00-115-0776 TERMINAL, LUG MS20659-114 96906	EA	2	4	
1	43	PAOZZ	PAOZZ	XBGZZ	PAFZZ	5	.020	6145-00-805-3354 CABLE, ELECTRICAL M13486-1-12 81349	FT	V	V	
1	44	PAOZZ	PAOZZ	PAGZZ	PAFZZ	D	.030	5935-00-295-6403 RECEPTACLE, SLAVE 10-40736-24 77820	EA	1	1	

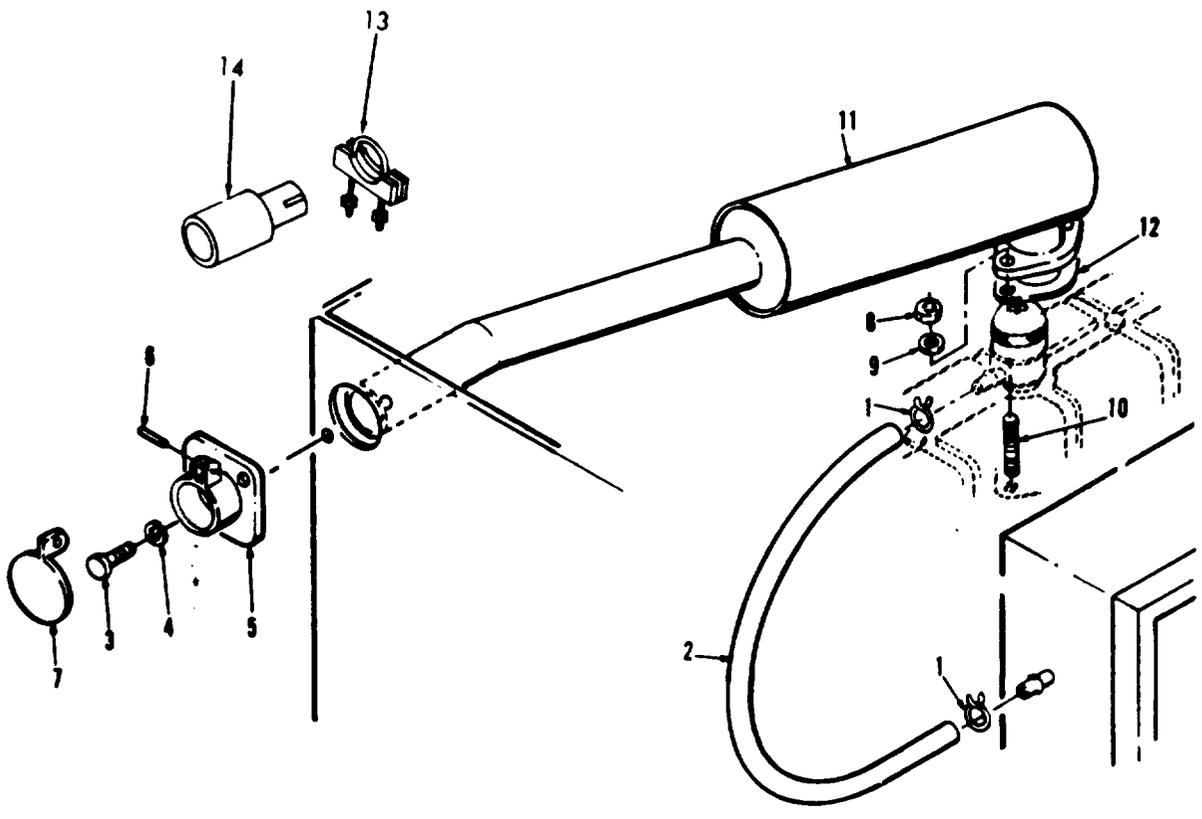

Figure 2. Exhaust pipe, muffler and breather tube.

**TM 9-6115-465-24P
TO 35C2-3-446-4
NAVFAC P-8-625-24P
SL-4-06858B/06859D**

(1) ILLUS- TRATION		(2) SMR CODE				(3)		(4)	(5) DESCRIPTION			(6)	(7)	(8)
a	b	a	b	c	d	a	b	NATIONAL STOCK NUMBER	REF NUMBER & MFR CODE	USABLE ON CODE	U/M	QTY INC IN UNIT	USMC QTY PER EQUIP	
FIG NO.	ITEM NO.	ARMY	AIR FORCE	NAVY	USMC	SSI	REPL FACTOR							
									GROUP 02-EXHAUST AND BREATHER PIPES					
2	1	XBOZZ	PAOZZ	XBOZZ	PAOZZ	D	.007	4730-01-005-6336	CLAMP HOSE M539326-14	96906	CLA, CLB, CLC, CZN, CZM	EA	2	2
2	1	PAOZZ	PAOZZ		PAOZZ	D	.007	4730-01-541-6584	CLAMP HOSE, DOG M539326-17	96906		EA	2	2
2	2	PAOZZ	PAOZZ	PAOZZ	PAOZZ	-	.070	4720-00-620-2202	HOSE, VENT 72-2060-2	30554		EA	1	1
2	3	PAOZZ	PAOZZ	PAOZZ	PAOZZ	D	.008	5305-00-068-0602	SCREW CAP HEX HEAD FLANGE MTG M590726-6	96906		EA	2	56
2	5	PAOZZ	PAOZZ	PAOZZ	PAOZZ	D	.008	5310-00-582-5965	WASHER, LOCK FLANGE MTD M63533U-44	96906		EA	2	256
2	5	XBOZZ	PAOZZ	XBGZZ	XBOZZ	-	-		FLANGE COVER TO EXHAUST PIPE 72-2051	30554		EA	1	1
									30554-72-2061	36024				
2	6	PAOZZ	PAOZZ	PAGZZ	PAOZZ	D	.010	5315-00-063-9016	PIN, ROLL RAIN COVER MTG NAS561C8-22	80205	CLA, CLB, CLC, CZN, CZM	EA	1	1
2	6	PAOZZ	PAOZZ		PAOZZ	D	.010	5315-00-291-973	PIN, ROLL RAIN COVER MTG M5171657	DGG 96906		EA	1	1
2	7	XBOZZ	PAOZZ	PAOZZ	PAOZZ	D	.010	5340-01-102-9937	COVER, RAIN 72-2053	30554		EA	1	1
									30554-72-2053	30624				
2	8	PAOZZ	PAOZZ	PAHZZ	PAOZZ	D	.008	5310-00-880-8189	NUT, PLAIN, HEX MUFFLER MTG MS51967-11	96906		EA	2	2
2	9	PAOZZ	PAOZZ	PAGZZ	PAOZZ	D	.010	5310-00-209-0965	WASHER, LOCK: MUFFLER MTG MS35338-47			EA	4	2
2	10	PAOZZ	PAOZZ	PAHZZ	PAOZZ	D	.037	5307-01-025-7842	STUD, PLAIN: MUFFLER MTG 72-2137	30554		EA	2	2
									30554-72-2137	36024				
2	11	PAOZZ	PAOZZ	PBHZZ	PAOZZ	-	.009	2090-00-611-5615	MUFFLER, EXHAUST 72-2054-2	30554		EA	1	1
									2538	80672				
2	12	PAOZZ	PAOZZ	PAGZZ	PAOZZ		.030	5330-01-385-4381	GASKET, MUFFLER 72-2057 NON-ASBESTOS	30554		EA	1	1
2	13	PAOZZ	PAOZZ		PAOZZ	D	.007	5340-00-626-9402	CLAMP MUFFLER 72-2156	30554	DGG	EA	1	1
2	14	PAOZZ	PAOZZ		PAOZZ	D	.007		ADAPTER, EXHAUST 72-2157	30554	DGG	EA	1	1

TM 9-6115-465-24P
TO 35C2-3-446-4
NAVFAC P-8-625-24P
SL-4-06858B/06859D

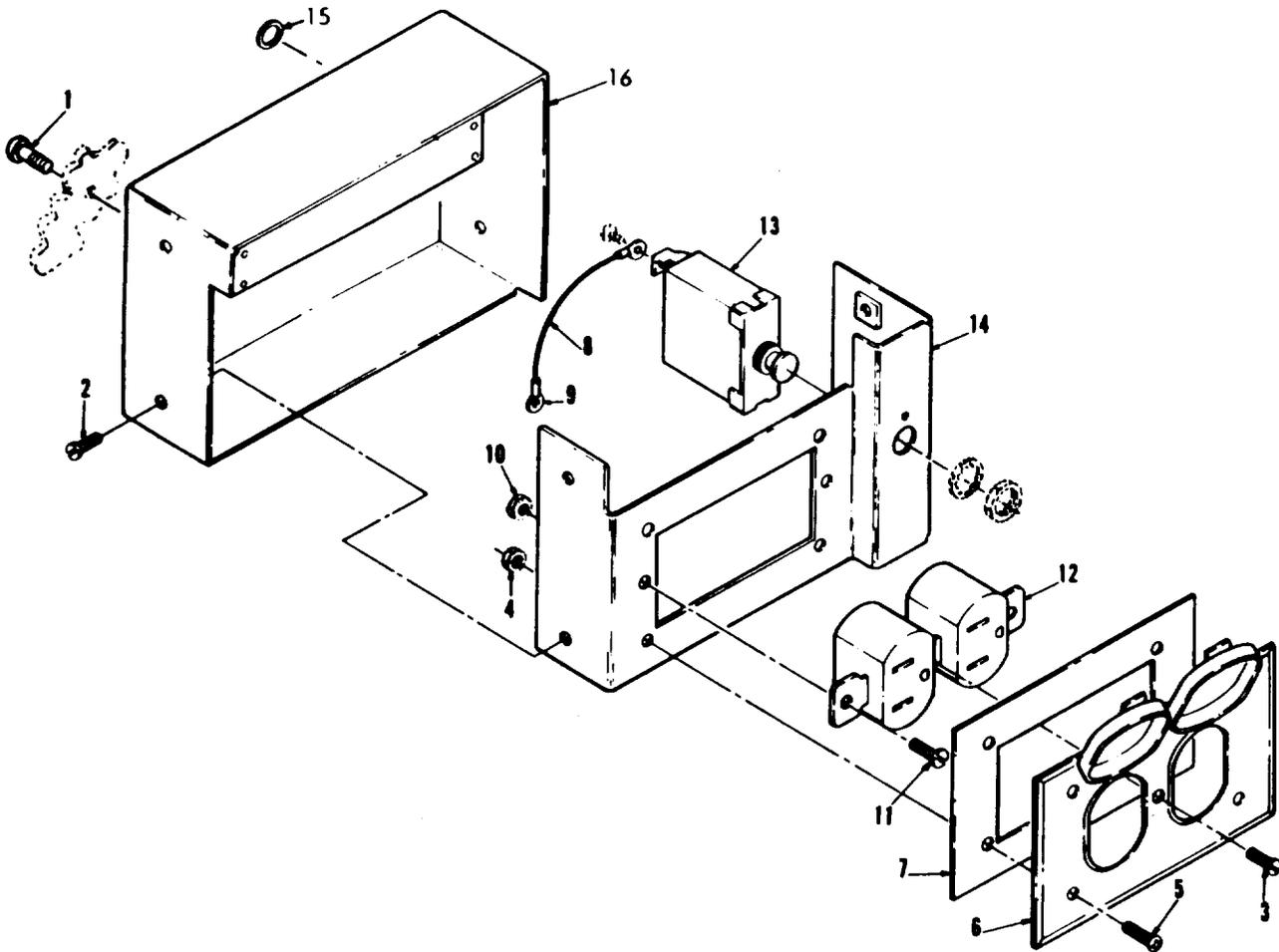

Figure 3. Convenience receptacles. (Landscape)

TM9-6115-465-24P
 TO 35C2-3-446-4
 NAVFAC P-8-625-24P
 SL-4-06858B/06859D

(1) ILLUSTRATION A FIG. NO.	(2) SMR CODE A ITEM NO.	B AIR FORCE	C NAVY	D USMC	(3)		(4) NATIONAL STOCK NUMBER	(5) DESCRIPTION REF NUMBER & MFR CODE	(6) USABLE ON CODE U/M	(7) QTY INC IN UNITS	(8) USMC QTY PER EQUIP	
					A	B REPL FACTOR						
								GROUP 03-CONVENIENCE RECEPTACLES 50/60 HZ				
3	1	PAOZZ	PAOZZ	PAOZZ	PAOZZ	D	.008	5305-00-191-6226		EA	3	42
		PAOZZ	AOO	AGGGG	AOOZZ			5935-01-009-3097		EA		
3	2	PAOZZ	PAOZZ	PAOZZ	PAOZZ	D	.008	5305-00-036-6968		EA	4	46
3	3	PAOZZ	PAOZZ	PAOFF	PAOZZ	D	.008	5305-00-059-4552		EA	1	1
3	4	PAOZZ	PAOZZ	PAOZZ	PAOZZ	D	.008	5310-00-063-7360		EA	4	51
3	5	PAOZZ	PAOZZ	XBOZZ	PAOZZ	D	.008	5305-00-889-3000		EA	4	4
3	6	PAOZZ	PAOZZ	PAGZZ	XBFZZ			5975-00-879-7234		EA	1	1
3	7	PAOZZ	PAOZZ	PAOZZ	PAOZZ	D	.080	5330-00-240-0834		EA	1	1
3	8	PAOZZ	PAOZZ	PAGZZ	PAOZZ	D	.080	6145-00-578-6605		FT	V	490
3	9	PAOZZ	PAOZZ	PAOZZ	PAOZZ	D	.060	5940-00-143-4774		EA	2	25
3	10	PAOZZ	PAOZZ	PAGZZ	PAOZZ	D	.008	5310-00-934-9747		EA	2	36
3	11	PAOZZ	PAOZZ	XBGZZ	PAOZZ	D	.008	5305-00-036-6968		EA	2	46
3	12	PAOZZ	PAOZZ	XBFZZ	PAOZZ	D	.030	5935-01-012-3080		EA	1	1
3	13	PAOZZ	PAOZZ	PAGZZ	PAOZZ		.050	5925-00-686-3301		EA	1	1
3	14	XBOZZ	XA	XBOZZ	XAOZZ			HOUSING 72-2275 30554 30554-72-2275 36024		EA	1	1
3	15	PAOZZ	PAOZZ	XBGZZ	PAOZZ	D	.050	5325-00-291-9366		EA	1	1
3	16	XBOZZ	XAO	XBGZZ	XBFZZ			GROMMET MS35409-11 96906 HOUSING, RECEPTACLE 72-2276 30554 30554-72-2276 36024		EA	1	1

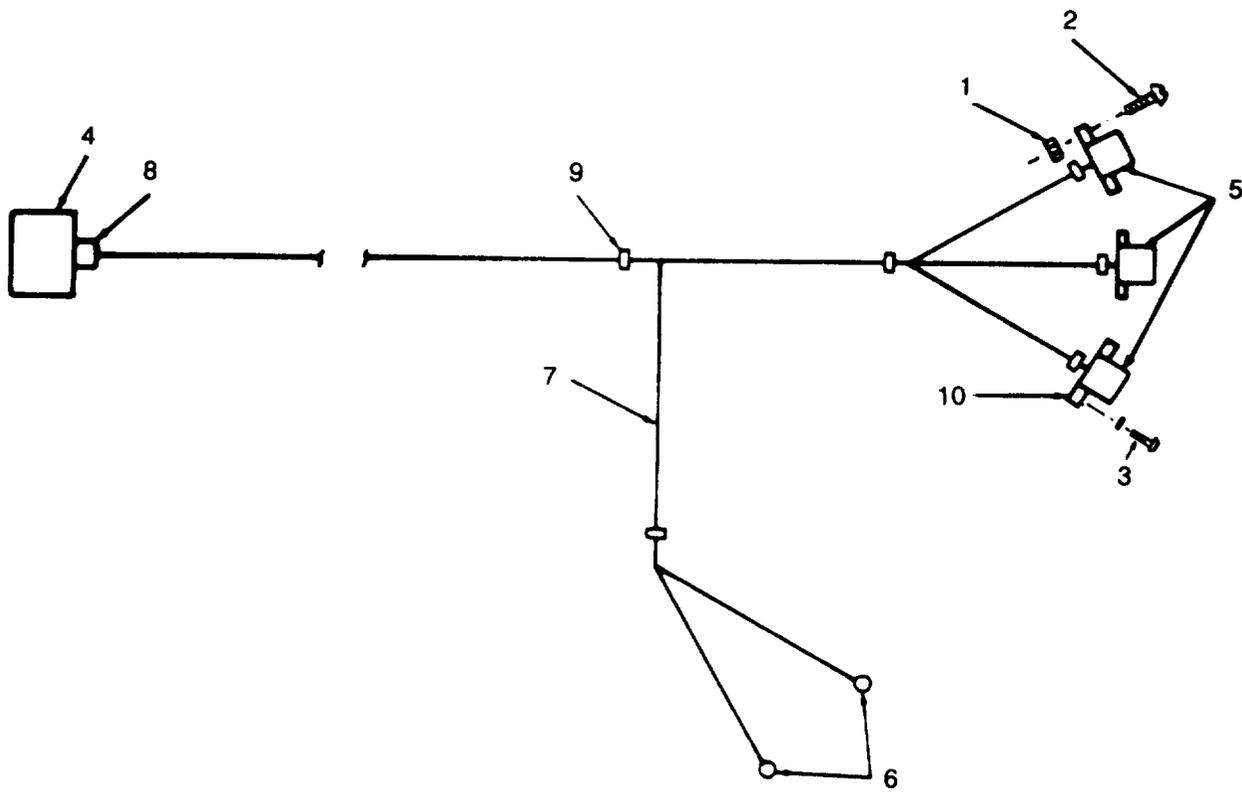

Figure 4. Paralleling and convenience receptacles.

(1) ILLUSTRATION		(2) SMR CODE				(3)		(4)	(5)	(6)	(7)	(8)
A	B	A	B	C	D	A	B	NATIONAL STOCK NUMBER	DESCRIPTION	USABLE ON CODE	QTY INC IN UNITS	USMC QTY PER EQUIP
FIG. NO.	ITEM NO.	ARMY	AIR FORCE	NAVY	USMC	SSI	REPL FACTOR		REF NUMBER & MFR CODE	U/M		
GROUP 04-CONVENIENCE RECEPTACLES 400 HZ												
4	1	PAOZZ	PAOZZ	PAGZZ	PAFZZ	D	.008	5310-00-761-6882	NUT, PLAIN, HEXAGON:CONNECTOR MTG MS51967-2 96906	EA	12	115
4	2	PAOZZ	PAOZZ	PAGZZ	PAFZZ	D	.008	5305-00-038-3089	SCREW WASHER:CONNECTOR MTG 69-662-3 30554 P15121-3 45722	EA	12	41
4	3	PAOZZ	PAOZZ	PAGZZ	PAFZZ	D	.008	5305-00-224-1092	SCREW WASHER:CONNECTOR MTG P15121-5 45722	EA	3	3
4		MFOUF	MOO	AGGGG	PAFZZ				WIRING, HARNESS: PARALLELING AND RECEPTACLES 72-2266 30554 30554-72-2286 36024 MANUFACTURE FROM:	EA	1	1
4	4	PAFZZ	PAOZZ	PAGZZ	PAFZZ	D	.023	5935-00-727-7560	CONNECTOR, ELECTRICAL MS3106R20-29P 96906	EA	1	1
4	5	PAFZZ	PAOZZ	PAGZZ	PAFZZ	D	.023	5935-00-801-6617	CONNECTOR, ELECTRICAL MS31Q2R18-4P 96906	EA	3	4
4	6	PAFZZ	PAOZZ	PAGZZ	PAFZZ	D	.050	5940-00-143-4774	TERMINAL, LUG MS25036-153 96906	EA	4	25
4	7	PAOZZ	PAOZZ	PAGZZ	PAFZZ	D	.050	6145-00-578-6605	WIRE, ELECTRICAL MS086-2-16-9 81349	FT	V	490
4	8	PAOZZ	PAOZZ		PAFZZ	D	.008	5970-00-954-1622	INSULATION, SLEEVING M2053-5-105-0 81349	FT	V	V
4	9	PAOZZ	PAOZZ	PAGZZ	PAFZZ	D	.008	5975-00-111-3208	STRAP, CABLE MS3367-5-9 96906	EA	V	232
4	10	PAFZZ	PAOZZ	PAGZZ	PAFZZ	D	.008	5935-00-823-5322	SEAL, PLUG MD25251-16 96906	EA	3	54

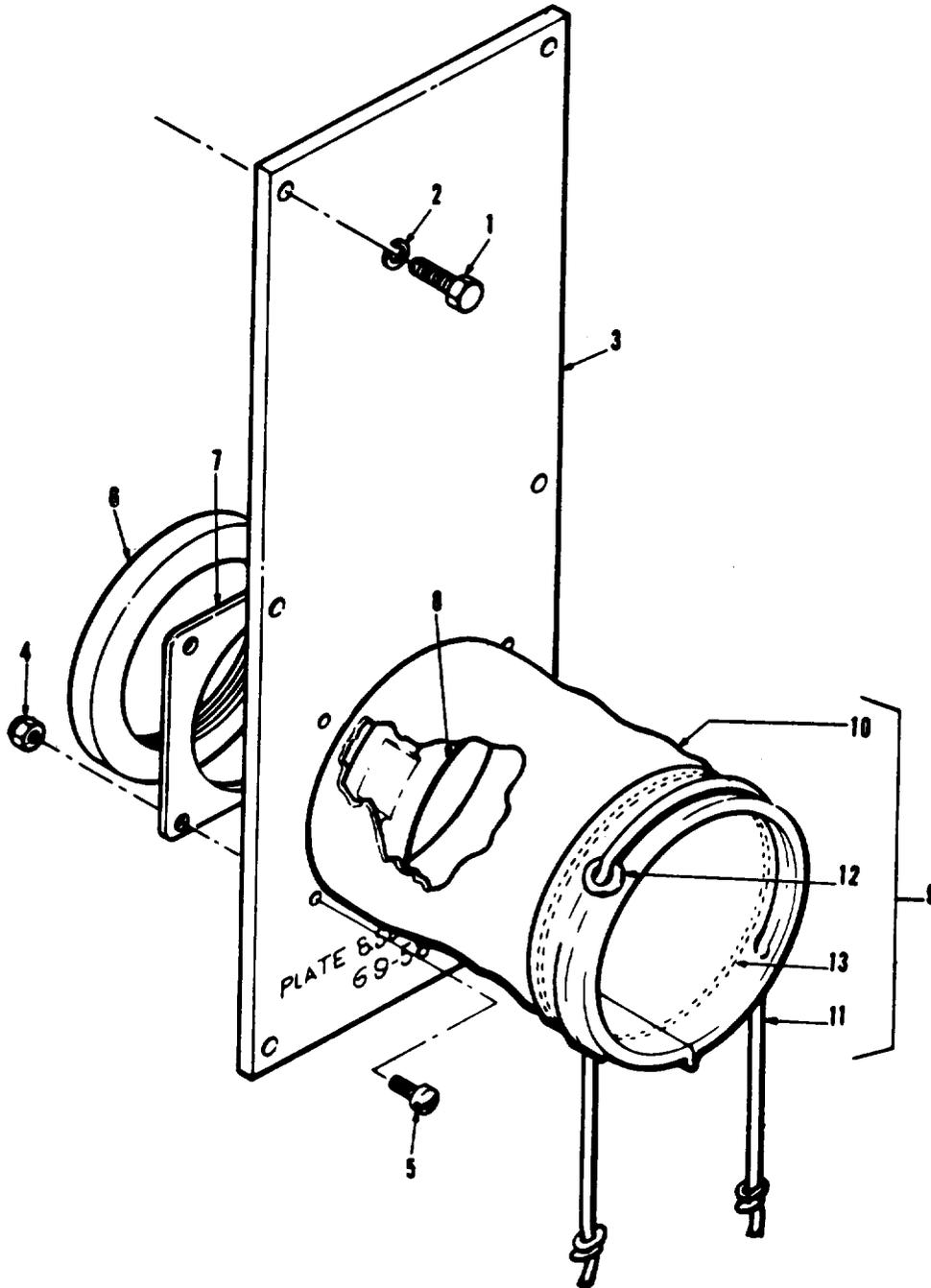

Figure 5. Plate and sleeve.

TM9-6115-465-24P
 TO 35C2-3-446-4
 NAVFAC P-8-625-24P
 SL-4-06858B/06859D

(1) ILLUSTRATION		(2) SMR CODE				(3)		(4)	(5)	(6)	(7)	(8)
A	B	A	B	C	D	A	B	NATIONAL STOCK NUMBER	DESCRIPTION	USABLE ON CODE	QTY INC IN UNITS	USMC QTY PER EQUIP
FIG. NO.	ITEM NO.	ARMY	AIR FORCE	NAVY	USMC	SSI	REPL FACTOR		REF NUMBER & MFR CODE		U/M	
GROUP 05-PLATE AND SLEEVE ASSEMBLY												
5	1	PAOZZ	PAOZZ	PAOZZ	PAOZZ	D	.008	5305-00-068-0500	SCREW,CAP,HEXAGON HEAD:PLATE MTG MS90725-3 96906	EA	6	179
5	2	PAOZZ	PAOZZ	PAOZZ	PAOZZ	D	.010	5310-00-582-5965	WASHER,LOCK:SLEEVE PLATE MTG MS35338-44 96906	EA	6	256
5	3	XBOZZ	AFO	PAGZZ	PAOZZ			6115-00-033-6623	PLATE,SLEEVE 69-580 30554 30554-69-580 36024	EA	1	1
5	4	PAOZZ	PAOZZ	PAGZZ	PAFZZ	D	.008	5310-00-052-3632	NUT,WASHER:PLATE COVER MTG 69-561-3 30554 511-081800-00 78189	EA	4	54
5	5	PAOZZ	PAOZZ	XBGZZ	PAFZZ	D	.008	5305-00-984-6193	SCREW,MACHINE:PLATE COVER MTG MS35206-245 96906	EA	4	17
5	6	XBOZZ	MFO	XBGZZ	XBFFZ				PLATE,RETAINER 69-583 30554 30554-69-583 36024	EA	1	1
5	7	XBOZZ	MFO	ZBGZZ	XBFFZ				PLATE,COVER 69-581 30554 30554-69-581 36024	EA	1	1
5	8	XBOZZ	PAOZZ	XBGZZ	PAFZZ			5970-00-097-9798	BUSHING,INSULATION 69-570-3 30554 1-3-0 95277	EA	1	1
5	9	PAOZZ	PAOZZ	XBGZZ	PAFZZ	D	.030	5975-00-421-6952	SLEEVE,DUST AND MOISTURE 69-582 30554 30554-69-582 36024	EA	1	1
5	10	XAOZZ	XB	XBGZZ	XAFZZ				CLOTH,COATED:SLEEVE MILC20696TYPEICLAS 81349	EA	V	V
5	11	XAOZZ	XB	XBOZZ	XAFZZ				CORD,COTTON MILR670TYPE4CLASS2 81349	FT	V	3
5	12	XAOZZ	XB	XBOZZ	XAFZZ				GROMMET,METALLIC:SLEEVE MILG16491TYPEICLAS 81349	EA	4	4
5	13	XAOZZ	XB	XBGZZ	XAFZZ				THREAD POLYESTER VT285TYPEIICLASS1 81349	SP	V	V

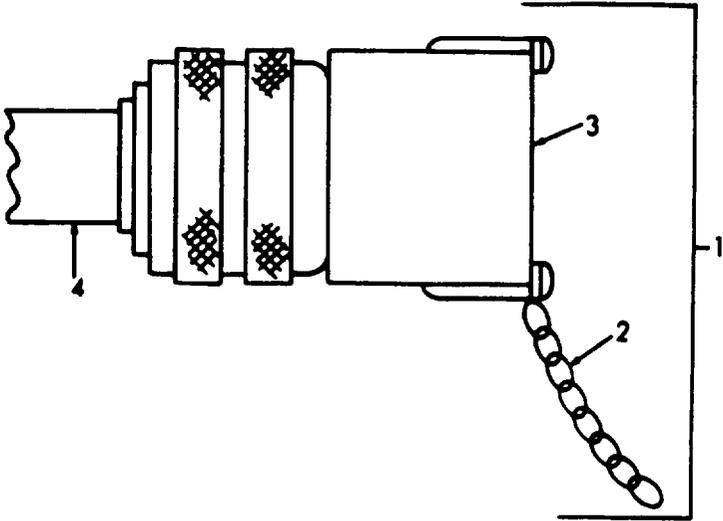

Figure 6. Shorting plug.

TM9-6115-465-24P
 TO 35C2-3-446-4
 NAVFAC P-8-625-24P
 SL-4-06858B/06859D

(1) ILLUSTRATION		(2) SMR CODE				(3)		(4) NATIONAL STOCK NUMBER	(5) DESCRIPTION	(6) USABLE ON CODE	(7) QTY INC IN UNITS	(8) USMC QTY PER EQUIP
A FIG. NO.	B ITEM NO.	A ARMY	B AIR FORCE	C NAVY	D USMC	A SSI	B REPL FACTOR	REF NUMBER & MFR CODE		U/M		
GROUP 06-PARALLELING RECEPTACLES												
6	1	PAOZZ	PAOZZ	XBGZZ	PAFZZ	D	.008	5935-00-601-6372	PLUG SHORTING 72-2231 30554	EA	1	1
6	2	XAOZZ	XAO	XAGZZ	XAFZZ				CHAIN RRC271 81349 TYPE II CLASS, BRASS 16	FT	V	
6	3	XAOZZ	XAO	XAGZZ	XAFZZ				CONNECTOR MS3106R18-4S 96906	EA	1	
6	4	XAOZZ	XAO	XAGZZ	XAFZZ				WIRE QQW343 TYPES 81348 16AWG	FT	V	

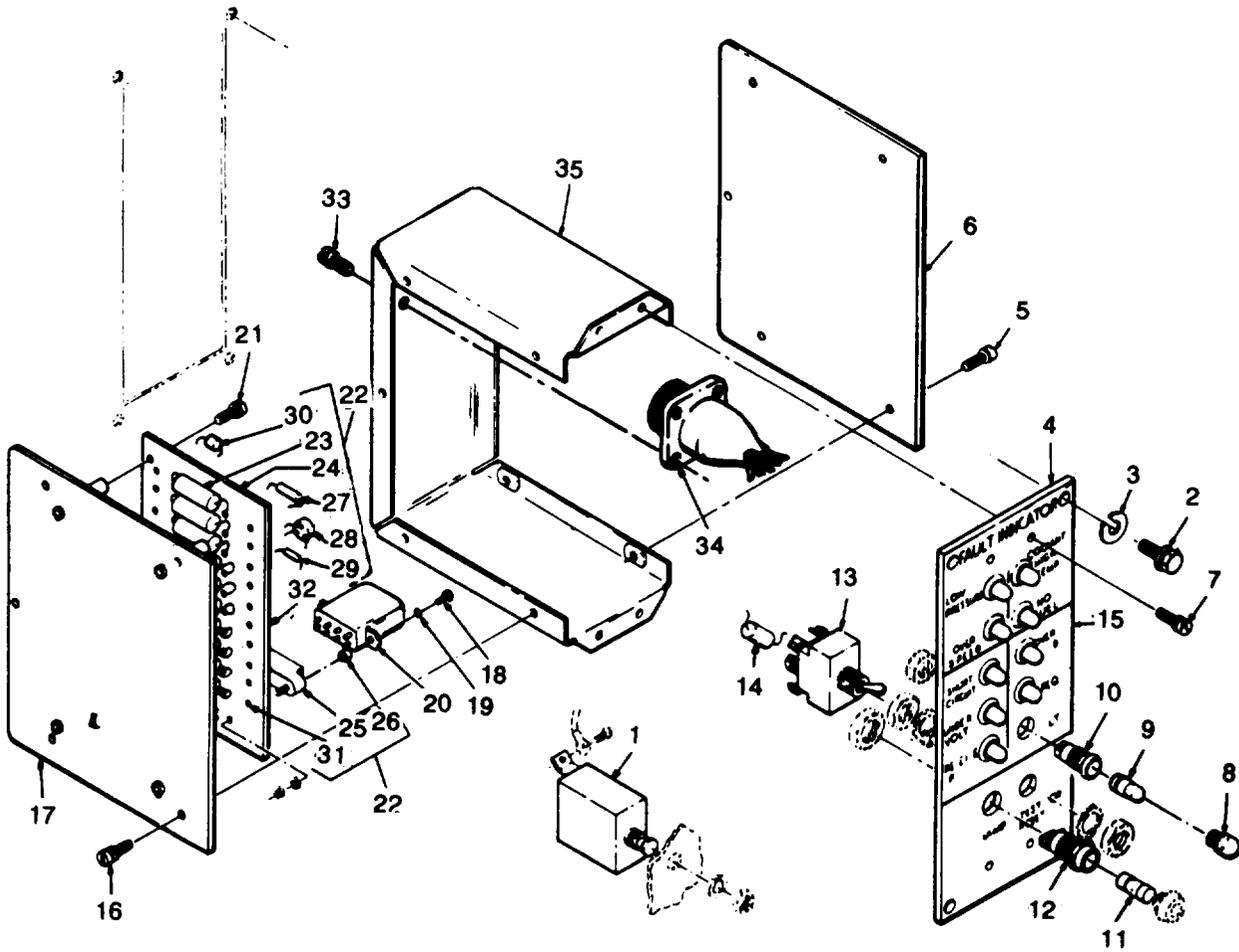

Figure 7. Fault locating indicator and D.C. circuit breaker.

(1) ILLUSTRATION A B FIG. ITEM NO. NO.		(2) SMR CODE A B C D ARMY AIR NAVY USMC				(3) A SSI		(4) NATIONAL STOCK NUMBER B REPL FACTOR		(5) DESCRIPTION REF NUMBER & MFR CODE		(6) USABLE ON CODE U/M		(7) QTY INC IN UNITS		(8) USMC QTY PER EQUIP	
GROUP 07-GENERATOR SET CONTROLS																	
7	1	PAOZZ	PAOZZ	PAGZZ	PAFZZ			.050	5925-00-686-3298	CIRCUIT BREAKER MS25244-1/2 96906		EA	1		1		
7	2	PAFZZ	PAOZZ	PAOZZ	PAFZZ	D		.008	5305-00-068-0500	SCREW,CAP,HEXAGON HEAD: FAULT INDICATOR MTG MS90725-3 96906	CLA,CLB CLC,DGG	EA	4		179		
7	2	PAFZZ	PAOZZ		PAFZZ	D		.008	5305-00-191-6226	SCREW AND CAPTIVE WASHER ASSY P15121-64 45722	CZM,CZN	EA	4		24		
7	3	PAFZZ	PAOZZ	PAOZZ	PAFZZ	D		.010	5310-00-582-5965	WASHER,LOCK:FAULT INDICATOR MTG MS35338-44 96906	CLA,CLB CLC,DGG	EA	4		256		
7	4	PBFFF	PAOFF	PBHHH	PAFFF			.700	6625-00-003-0976	INDICATOR:FAULT LOCATING 69-530 30554 30554-69-530 36024		EA	1		1		
7	5	PAFZZ	PAOZZ	PAOZZ	PAFZZ	D		.008	5305-00-036-6968	SCREW,WASHER:COVER MTG 69-662-18 30554 P-15121-18 45722		EA	5		46		
7	6	XBFZZ	MOO	XBGZZ	XBFZZ					COVER,SIDE 69-536 30554 30554-69-536 36024		EA	1		1		
7	7	PAFZZ	PAOZZ	PAOZZ	PAFZZ]	D		.008	5305-00-036-6968	SCREW,WASHER:INDICATOR MTG 69-662-18 30554 P15121-18 45722		EA	4		46		
7	8	PAOZZ	PAOZZ	PAHZZ	PAOZZ	D		.010	6210-00-990-4637	LENS,LIGHT LC12RN2 81349		EA	10		10		
7	9	PAOZZ	PAOZZ	PAOZZ	PAOZZ			.230	6240-00-155-7836	LAMP,INCANDESCENT MS25237-327 96906		EA	10		10		
7	10	PAFZZ	PAOZZ	XBHZZ	PAFZZ			.010	6210-00-813-8265	LIGHT,INDICATOR LH73-1 81349		EA	10		10		
7	11	PAOZZ	PAOZZ	PAOZZ	PAOZZ			2.000	5920-00-280-4465	FUSE F02A250V1AS 81349		EA	1		1		
7	12	PAFZZ	PAOZZ	PAGZZ	PAFZZ	D		.008	5920-00-875-4100	FUSEHOLDER FHN26G2 81349		EA	1		1		
7	13	PAFZZ	PAOZZ	PAGZZ	PAFZZ			.050	5930-00-615-7880	SWITCH,TOGGLE MS35059-26 96906		EA	1		1		
7	14	PAFZZ	PAOZZ	PAGZZ	PAFZZ	D		.050	5910-00-009-9998	CAPACITOR,FIXED M59006/02-1300 81349	CLA,CLB CLC,CZN CZM	EA	1		1		
7	14	PAFZZ	PAOZZ	PAGZZ	PAFZZ	D		.050	5910-00-233-1780	CAPACITOR,FIXED M39006-02-1246 81349	DGG	EA	1		1		
7	15	XBFZZ	XA	XBGZZ	XBFZZ					PANEL,INDICATOR 69-532 30554 30554-69-532 36024		EA	1		1		
7	16	PAFZZ	PAOZZ	PAOZZ	PAFZZ	D		.008	5305-00-036-6968	SCREW,WASHER:BOTTOM PLATE MTG 69-662-18 30554 P15121-18 45722		EA	5		46		
7	17	XBFZZ	MOO	XBFZZ	XBFZZ					PLATE,BOTTOM 69-533 30554 30554-69-533-36024		EA	1		1		

(1) ILLUSTRATION A FIG. NO.	(2) SMR CODE B ITEM NO.	(3) A ARMY	(3) B AIR FORCE	(3) C NAVY	(3) D USMC	(3) A SSI	(4) NATIONAL STOCK NUMBER B REPL FACTOR	(5) DESCRIPTION REF NUMBER & MFR CODE	(6) USABLE ON CODE U/M	(7) QTY INC IN UNITS	(8) USMC QTY PER EQUIP
7	18	PAFZZ	PAOZZ	PAOZZ	PAFZZ	D	.008	5305-00-984-4982 SCREW,MACHINE,RELAY MTG MS35206-225 96906	EA	2	12
7	19	PAFZZ	PAOZZ	PAOZZ	PAFZZ	D	.010	5310-00-045-4007 WASHER,LOCK:RELAY MTG MS35338-41 96906	EA	2	12
7	20	PAFZZ	PAOZZ	PAHZZ	PAFZZ		.050	5945-00-435-1833 RELAY M575723-003 81349	EA	1	6
7	21	PAFZZ	PAOZZ	PAOZZ	PAFZZ	D	.008	5305-00-036-6968 SCREW,WASHER:INDICATOR MTG 69-662-18 30554 P15121-18 45722	EA	4	46
7	22	XBFZZ	PAOFF	PBGGG	PAFZZ			6110-00-199-1278 INDICATOR ASSEMBLY,FAULT 69-540 30554	EA	1	1
7	23	PAFZZ	PAOZZ	PAGZZ	PAFZZ		.050	5910-00-009-9998 CAPACITOR,FIXED M39006-02-1272 81349	EA	10	10
7	24	PAFZZ	PAOZZ	XBGZZ	PAFZZ	D	.008	5970-00-954-1622 INSULATION,SLEEVING M23053/5-105-0 81349	FT	V	V
7	25	XBFZZ	PAOZZ	XBGZZ	PAFZZ		.050	5935-00-210-8648 SOCKET,RELAY 69-547 30554 VB1UA11-47-000300 05574	EA	1	1
7	26	XBFZZ	PAOZZ	XBGZZ	PAFZZ			5365-00-216-1229 SPACER,SOCKET 70-514 30554 30554-70-514 36024	EA	2	2
7	27	PAFZZ	PAOZZ	PAGZZ	PAFZZ		.040	5905-00-141-1168 RESISTOR,FIXED RCR20G222JS 81349	EA	10	10
7	28	PAFZZ	PAOZZ	PAGZZ	PAFZZ		.040	5961-00-079-5958 RECTIFIER 69-542 30554 2N1596 80131	EA	10	10
7	29	PAFZZ	PAOZZ	PAGZZ	PAFZZ		.040	5905-00-110-0196 RESISTOR,FIXED RCR20G102JS 81349	EA	10	10
7	30	PAFZZ	PAOZZ	PAGZZ	PAFZZ		.040	5961-00-811-8372 RECTIFIER 69-543 30554 JANIN3189 81349	EA	10	10
7	31	PAFZZ	PAOZZ	XBGZZ	PAFZZ	D	.008	5940-00-767-1596 TERMINAL,STUD MS17157-10 96906	EA	50	50
7	32	XAFZZ	XA	XBOZZ	XAFZZ			BOARD,CIRCUIT 65-541 30554 30554-69-541 36024	EA	1	1
7	33	PAFZZ	PAOZZ	PAOZZ	PAFZZ	D	.008	5305-00-036-6977 SCREW,WASHER 69-662-33 30554 P15121-33 45722	EA	4	8
7	34	MFFF	AOO	AGGGG	AFPZZ			WIRING HARNESS:FAULT LOCATING INDICATOR 70-515 30554 30554-72-515 36024 MANUFACTURE FROM:	EA	1	1
7		PAFZZ	PAOZZ	PAGZZ	PAFZZ	D	.030	5935-00-007-2179 CONNECTOR,RECEPTACLE 690-502-7 30554 30554-69-502-7 36024	EA	1	1

TM9-6115-465-24P
 TO 35C2-3-446-4
 NAVFAC P-8-625-24P
 SL-4-06858B/06859D

(1) ILLUSTRATION		(2) SMR CODE				(3)		(4) NATIONAL STOCK NUMBER	(5) DESCRIPTION	(6) USABLE ON CODE	(7) QTY INC IN UNITS	(8) USMC QTY PER EQUIP
A FIG. NO.	B ITEM NO.	A ARMY	B AIR FORCE	C NAVY	D USMC	A SSI	B REPL FACTOR	REF NUMBER & MFR CODE	U/M			
7		PAFZZ	PAOZZ	XBGZZ	PAFZZ	D	.008	5970-00-915-6133 INSULATION 187C704P433 89954	CLA, CLB CLC	FT	1 1	
7		PAFZZ	PAOZZ		PAFZZ	D	.008	5970-00-954-1622 INSULATION SLEEVING M230535-105-0 81349	CZN, CZM DGG	FT	1 V	
7		PAFZZ	PAOZZ	PAGZZ	PAFZZ	D	.008	5975-00-074-2072 STRAP, CABLE MS3367-1-9 96906 CZM	CLA, CLB CLC, CZN	EA	25 195	
7		PAFZZ	PAOZZ		PAFZZ	D	.008	5975-00-111-3208 STRAP MS3367-5-9 96906	DGG	EA	25 232	
7		PAFZZ	PAOZZ	XBGZZ	PAFZZ	D		6145-00-548-0969 WIRE, ELECTRICAL M16878-4-22-9 81349	DGG	FT	50 50	
7	35	XBFZZ	XA	XBGZZ	XBFZZ			CHASSIS 69-545 30554 30554-69-545 36024	EA	1 1		

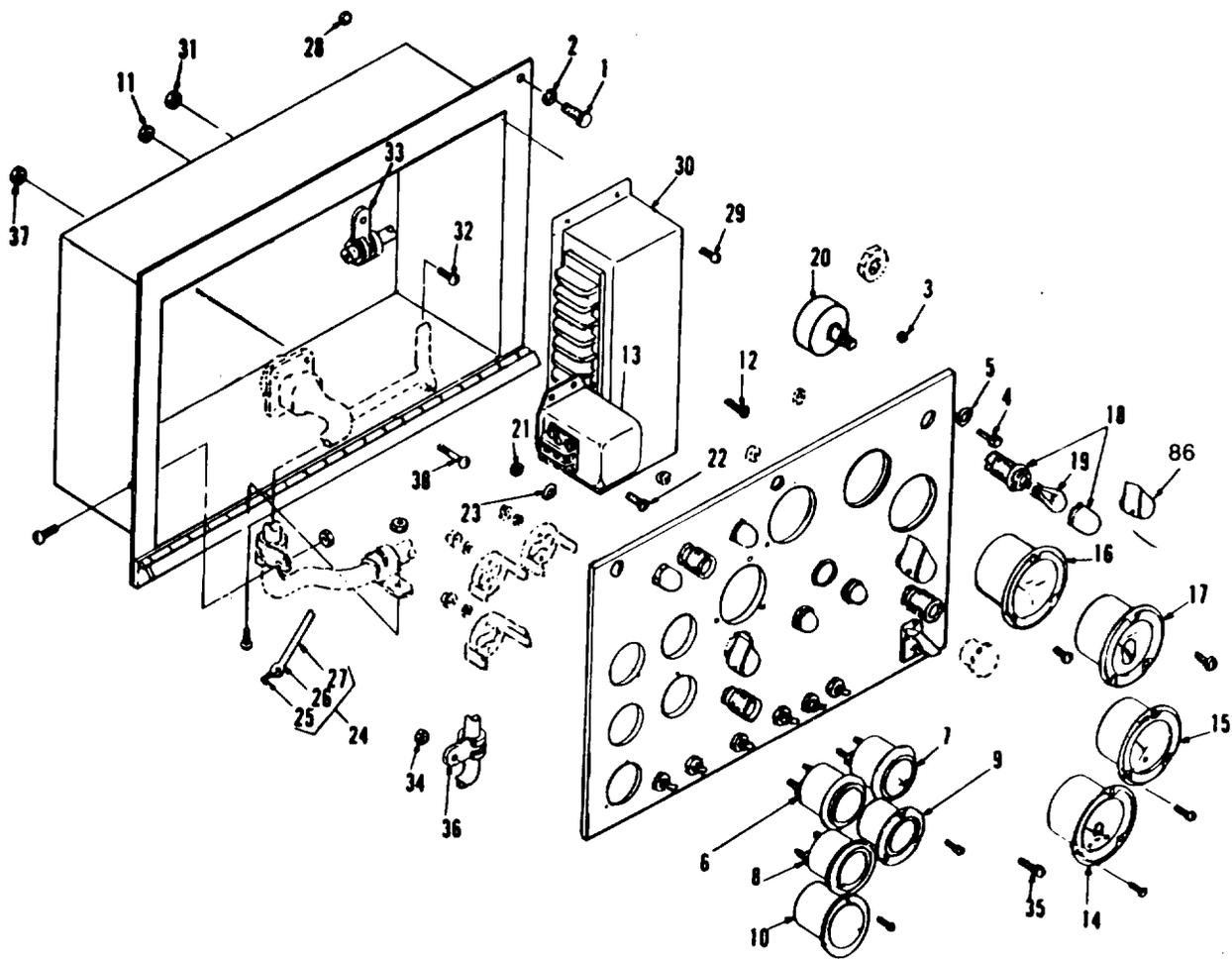

Figure 8. Control cubicle assembly and manual speed control. (sheet 1 of 2) (Landscape)

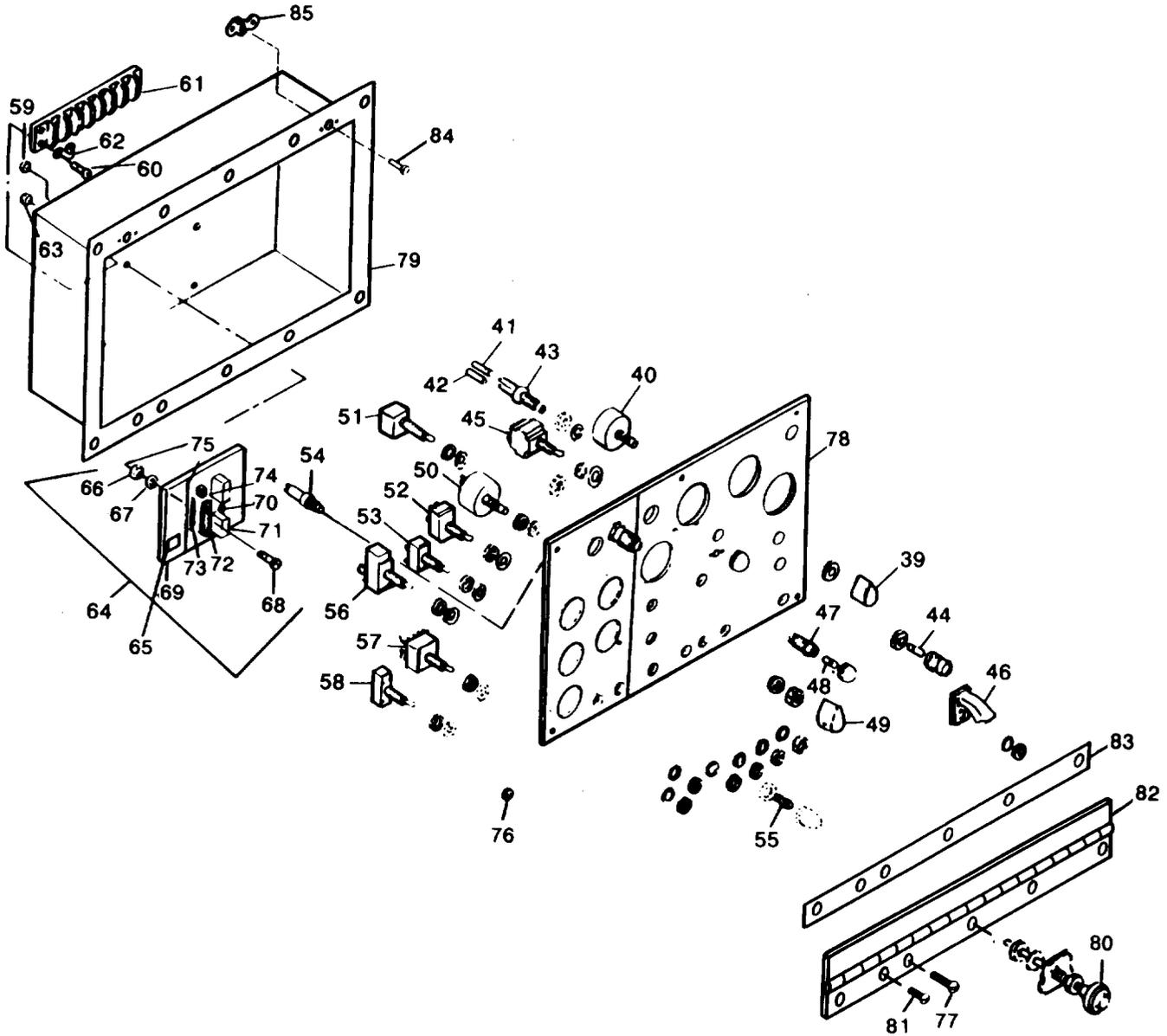

Figure 8. Control cubicle assembly and manual speed control. (sheet 2 of 2) (Landscape)

TM 9-6115-465-24P
TO 35C2-3-446-4
NAVFAC P-8-625-24P
SL-4-06858B/06859D

(1) ILLUS- TRATION		(2) SMR CODE				(3)		(4)	(5) DESCRIPTION		(6)	(7)	(8)
a	b	a	b	c	d	a	b	NATIONAL STOCK NUMBER	REF NUMBER & MFR CODE	USABLE ON CODE	U/M	QTY INC IN UNIT	USMC QTY PER EQUIP
FIG NO.	ITEM NO.	ARMY	AIR FORCE	NAVY	USMC	SSI	REPL FACTOR						
8	1	PAOZZ	PAOZZ	PAOZZ	PAFZZ	D	.008	5310-00-006-0500	SCREW, CAPHEX HEAD CUBICAL MTG MS90725-3 96906		EA	14	179
8	2	PAOZZ	PAOZZ	PAOZZ	PAFZZ	D	.010	5310-00-582-5965	WASHER, LOCK CUBICAL MTG MS3533-44 96906		EA	14	256
8		XBOOH	AFD	AGGGG	AFFFF	-	.008	6110-00-201-8315	CUBICAL ASSEMBLY 69-590-1 30554 30554-69-590-1 36024 (SAME AS CUBICAL ASSEMBLY NSN 6115-00-092-5116 EXCEPT WHERE INDIVIDUAL COMPONENTS ARE ANNOTATED)	CLA, CLB, CZN, CZM	EA	1	1
8		XBOOH	AFD	AGGGG	AFFFF	-	.008	6110-00-092-5116	CUBICAL ASSEMBLY 69-590-2 30554 30554-69-590-2 36024	CLC	EA	1	3
8		XBOOH	AFD	AGGGG	AFFFF	-	.008		CUBICAL ASSEMBLY 69-590-4 30554	DGG	EA	1	3
8	3	XBOZZ	PAOZZ	PAGZZ	PAOZZ	D	.008	5310-00-449-2945	PIN CROSS CONTROL BOX DOOR 69-695 30554 99836 96530		EA	3	3
8	4	XBOZZ	PAOZZ	PAGZZ	PAOZZ	D	.008	5325-00-432-9902	STUD TURNLOCK: PANEL FASTENER 69-694-6 30554 98292-2-250 96530		EA	3	3
8	5	XBOZZ	PAOZZ	PAOZZ	PAOZZ	D	.050	5325-00-099-8827	GROMMET PANEL FASTENER STUD 69-766 30554 295901-2 96530		EA	3	1
8	6	PAOZZ	PAOZZ	PBHZZ	PAFZZ	-	.050	6620-01-005-4879	INDICATOR, OIL PRESSURE 69-576-1 30554 505AS 57733		EA	1	1
8	7	PAOZZ	PAOZZ	PBHZZ	PAFZZ	-	.050	6620-00-857-0862	INDICATOR, TEMPERATURE 505BE 57733 69-577 30554		EA	1	1
8	8	PAOZZ	PAOZZ	PBHZZ	PAFZZ	-	.050	6680-00-857-0856	INDICATOR, FUEL LEVEL 505BC 57733 69-575 30554		EA	1	1
8	9	PAOZZ	PAOZZ	PBHZZ	PAFZZ	-	.030	6825-00-8S9-3141	AMMETER, DC 253633 65092 69-574 30554		EA	1	1
8	10	PAOZZ	PAOZZ	PBHZZ	PAFZZ	-	.004	6645-00-089-8842	METER, TIME TOTAL 73-0507 30554 M5600 74400		EA	1	1
8	11	PAOZZ	PAOZZ	PAGZZ	PAFZZ	D	.008	5310-00-052-3632	NUT WASHER ASSEMBLY, TRANSDUCER MTG 69-581-3 30554 511-081800-00 78189		EA	4	54
8	12	PAOZZ	PAOZZ	XBGZZ	PAFZZ	D	.008	5305-00-984-6193	SCREW, MACHINE TRANSDUCER MTG MS35206-245 96906		EA	4	15
8	13	PAOZZ	PAOZZ	PBHZZ	PAFZZ	-	.030	6625-00-003-0971	METER, FREQUENCY MATCHED SET 69-595 30554 268420 85092	CLA, CLB, CZN, CZM	SE	1	1
8	14	PAOZZ	PAOZZ	PBHZZ	PAFZZ	-	.030	625-00-003-0972	METER, FREQUENCY MATCHED SET 69-595 30554 268421 65092	CLC, DGG	SE	1	1

TM9-6115-465-24P
 TO 35C2-3-446-4
 NAVFAC P-8-625-24P
 SL-4-06858B/06859D

(1) ILLUSTRATION		(2) SMR CODE				(3)		(4) NATIONAL STOCK NUMBER	(5) DESCRIPTION	(6) USABLE ON CODE	(7) QTY INC IN UNITS	(8) USMC QTY PER EQUIP
A FIG. NO.	B ITEM NO.	A ARMY	B AIR FORCE	C NAVY	D USMC	A SSI	B REPL FACTOR	REF NUMBER & MFR CODE	U/M			
8	15	PAOZZ	PAOZZ	PBHZZ	PAFZZ		.030	6625-00-003-0975 METER,KILOWATT 70-4012 30554 260935 65092	EA	1	1	
8	16	PAOZZ	PAOZZ	PBHZZ	PAFZZ		.030	6625-00-004-8066 METER,CURRENT 69-597 30554 267842 65092	CLA,CLB CZN,CZM	EA	1	1
8	16	PAOZZ	PAOZZ	PBHZZ	PAFZZ		.030	6625-00-081-5840 METER,CURRENT 69-598 30554 254014 65092	CLC,DGG	EA	1	1
8	17	PAOZZ	PAOZZ	PBHZZ	PAFZZ		.030	6625-00-869-3144 METER,VOLTAGE 69-599 30554 254013 30554	EA	1	1	
8	18	PAOZZ	PAOZZ	XBGZZ	PAFZZ		.040	6210-00-935-6919 LIGHT,PANEL 69-593 30554 47-0901-2900-201 72619	EA	3	3	
8	19	PAOZZ	PAOZZ	PAOZZ	PAOZZ		.160	6240-00-155-7878 LAMP,INCANDESCENT 69-594 30554 686-30V 08805	EA	3	3	
8	20	PAOZZ	PAOZZ	PAGZZ	PAFZZ		.050	5930-00-214-0431 SWITCH,VOLT 70-4016 30554 31904LT 82121	EA	1	1	
8	21	PAOZZ	PAOZZ	PAGZZ	PAFZZ	D	.008	5310-00-052-3632 NUT WASHER ASSEMBLY:DOOR HOLDER MTG 69-561-3 30554 511-081800-00 78189	EA	2	54	
8	22	PAOZZ	PAOZZ	XBGZZ	PAFZZ		.008	5305-00-984-6193 SCREW,MACHINE:DOOR HOLDER MTG MS35206-245 96906	EA	2	15	
8	23	PAOZZ	PAOZZ	PAGZZ	PAFZZ	D	.010	5310-00-809-8544 WASHER,FLAT:DOOR HOLDER MTG MS27183-7 96906	EA	2	17	
8	24	XBOZZ	AFO	XBGZZ	MOOZZ			HOLDER,DOOR 69-763 30554	EA	2	2	
8	25	PAOZZ	PAOZZ	PAOZZ	PAOZZ	D	.007	4030-00-780-9350 HOOK,CHAIN:DOOR HOLDER MS87006-13 96906	EA	1	3	
8	26	PAOZZ	PAOZZ	PAGZZ	PAOZZ	D	.008	5940-00-115-2677 TERMINAL,LUG:DOOR HOLDER MS20659-14 96906	EA	2	4	
8	27	PAOZZ	PAOZZ	XBOZZ	PAOZZ	D	.123	4020-00-141-7152 ROPE,NYLON:DOOR HOLDER MLLR17343 81349	FT	2	7	
8	28	PAOZZ	PAOZZ	PAGZZ	PAFZZ	D	.008	5310-00-052-3632 NUT WASHER ASSEMBLY 69-561-3 30554 511-081800-00 78189	EA	4	54	
8	29	PAOZZ	PAOZZ	PAGZZ	PAOZZ	D	.008	5305-00-984-6193 SCREW,MACHINE:CONVERTER MTG MS35206-245 96906	EA	4	15	

(1) ILLUSTRATION		(2) SMR CODE				(3)		(4) NATIONAL STOCK NUMBER	(5) DESCRIPTION	(6) USABLE ON CODE	(7) QTY INC IN UNITS	(8) USMC QTY PER EQUIP
A FIG. NO.	B ITEM NO.	A ARMY	B AIR FORCE	C NAVY	D USMC	A SSI	B REPL FACTOR	REF NUMBER & MFR CODE	U/M			
8	30	PAOZZ	PAOZZ	PAGZZ	PAFZZ		.030	6625-00-003-0973 CONVERTER,WATT 69-589-1 30554 268086 65092	CLA,CLB CZN,CZM	EA	1 1	
8	30	PAOZZ	PAOZZ	PAGZZ	PAFZZ		.030	6625-00-003-0974 CONVERTER,WATT 69-589-2 30554 268087 65092	CLC,DGG	EA	1 1	
8	31	PAFZZ	PAOZZ	PAGZZ	PAFZZ	D	.008	5310-00-094-3421 NUT WASHER ASSEMBLY:CLAMP MTG 69-561-4 30554 511-101800-00 78189		EA	4 8	
8	32	PAFZZ	PAOZZ	PAGZZ	PAFZZ	D	.008	5305-00-145-0960 SCREW,MACHINE:CLAMP MTG MS35206-338 96906		EA	3 6	
8	33	PAOZZ	PAOZZ	PAGZZ	PAFZZ	D	.008	5340-00-057-2904 CLAMP,LOOP:WIRING HARNESS MS21333-71 96906		EA	1 1	
8	34	PAOZZ	PAOZZ	PAGZZ	PAFZZ	D	.008	5310-00-052-3632 NUT WASHER ASSEMBLY:CLAMP MTG 69-561-3 30554 511-081800-00 78189		EA	3 54	
8	34	PAOZZ	PAOZZ	PAGZZ	PAFZZ	D	.008	5310-00-052-3632 NUT WASHER ASSEMBLY:CLAMP MTG 69-561-3 30554 511-081800-00 78189		EA	3 54	
8	35	PAFZZ	PAOZZ	PAGZZ	PAFZZ	D	.008	5305-00-984-6193 SCREW,MACHINE:CLAMP MTG MS35206-245 96906		EA	3 15	
8	36	PAOZZ	PAOZZ	PAGZZ	PAFZZ	D	.008	5340-00-050-2740 CLAMP,LOOP:WIRING HARNESS MS21333-75 96906		EA	3 16	
8	37	PAFZZ	PAOZ	PAGZZ	PAFZZ	D	.008	5310-00-052-3632 NUT WASHER ASSEMBLY:WIRING HARNESS MTG 69-561-3 30554 511-081800-00 78189		EA	4 8	
8	38	PAFZZ	PAOZZ	PAGZZ	PAFZZ	D	.008	5305-00-984-6193 SCREW,MACHINE:WIRING HARNESS MTG MS35206-245 96906		EA	4 15	
8	39	XBOZZ	PAOZZ	PAOZZ	PAFZZ	D	.020	5355-00-916-2080 KNOB,CONTROL RHEOSTAT MS91528-2P4B 96906		EA	1 2	
8	40	PAOZZ	PAOZZ	PAGZZ	PAFZZ		.090	5905-00-264-7368 RHEOSTAT,VOLTAGE ADJUST 69-548 30554 M22-03-00161FD 81349		EA	1 1	
8	41	PAOZZ	PAOZZ		PAFZZ	D	.008	5970-00-954-1622 INSULATION,SLEEVING M23053/5-105-0 81349		FT	1 V	
8	42	PAOZZ	PAOZZ		PAFZZ	D	.008	5970-00-815-1295 INSULATION,SLEEVING		FT	1 V	
8	43	PAOZZ	PAOZZ	PAGZZ	PAFZZ		.040	6210-00-686-4999 LIGHT ASSEMBLY,INDICATOR MS25331-2 96906		EA	2 2	
8	44	PAOZZ	PAOZZ	PAOZZ	PAOZZ	D	.160	6240-00-155-8714 LAMP M525231-313 96906		EA	2 2	
8	45	PAOZZ	PAOZZ	PAHZZ	PAFZZ		.050	5930-00-655-1581 SWITCH,TOGGLE:BATTLE SHORT MS25068-23 96906		EA	1 2	
8	46	PAOZZ	PAOZZ	PAHZZ	PAFZZ		.008	5930-00-615-6731 GUARD,TOGGLE SWITCH MS25224-1 96906		EA	1 1	
8	47	PAOZZ	PAOZZ	XBGZZ	PAFZZ		.040	6210-00-831-8247 LIGHT,SYNCHRONIZING 69-549 30554 51-3502-0137-203 72519		EA	2 2	

(1) ILLUSTRATION A FIG. NO.	(2) SMR CODE B ITEM NO.	(3)				(4) NATIONAL STOCK NUMBER	(5) DESCRIPTION REF NUMBER & MFR CODE	(6) USABLE ON CODE U/M	(7) QTY INC IN UNITS	(8) USMC QTY PER EQUIP		
		A	B	C	D							
8	48	PAOZZ	PAOZZ	PAOZZ	PAOZZ	.230	6240-00-143-3060	LAMP, INCANDESCENT MS15567-1 96906	EA	2	4	
8	49	XBOZZ	PAOZZ	PAOZZ	PAFZZ	D	.020	5355-00-916-2060	KNOB, CONTROL: RHEOSTAT MS91528-2P4B 96906	EA	1	2
8	50	PAOZZ	PAOZZ	PAGZZ	PAFZZ		.090	5905-00-665-7856	RHEOSTAT 69-571-1 30554 M22-04-00181FD 81349	EA	1	1
8	51	PAOZZ	PAOZZ	PAHZZ	PAFZZ		.050	5390-00-655-1581	SWITCH, TOGGLE: PARALLEL OPERATION MS25068-23 96906	EA	1	2
8	52	PAOZZ	PAOZZ	PAGZZ	PAFZZ		.050	5930-00-655-1582	SWITCH, TOGGLE: REMOTE CONTROL MS35059-23 96906	EA	1	1
8	53	PAOZZ	PAOZZ	PAGZZ	PAFZZ		.050	5930-00-655-1514	SWITCH, TOGGLE: PANEL LIGHT MS35058-22 96906	EA	1	1
8	54	PAOZZ	PAOZZ	PAGZZ	PAFZZ	D	.050	6210-00-688-5088	LIGHT ASSEMBLY: CIRCUIT BREAKER MS25331-4 96906	EA	1	2
8	55	PAOZZ	PAOZZ	PAOZZ	PAOZZ		.040	6240-00-155-8714	LAMP MS25231-313 96906	EA	1	4
8	56	PAOZZ	PAOZZ	PAHZZ	PAFZZ		.160	5390-00-044-3518	SWITCH, TOGGLE: CIRCUIT BREAKER GLOW MS25201-6 96906	EA	1	1
8	57	PAOZZ	PAOZZ	PAGZZ	PAFZZ		.050	5930-00-782-8590	SWITCH, TOGGLE: ENGINE START-RUN- STOP 69-572 30554 8906K1359 27192	EA	1	1
8	58	PAOZZ	PAOZZ	PAGZZ	PAFZZ		.050	5930-00-655-1522	SWITCH, TOGGLE: ENGINE PRIMER MS35058 96906	EA	1	1
8	59	PAOZZ	PAOZZ	PAGZZ	PAFZZ	D	.050	5310-00-052-3632	NUT, WASHER ASSEMBLY: TERMINAL BOARD MTG 69-561-3 30554 511-081800-00 78189	EA	4	54
8	60	PAOZZ	PAOZ	PAGZZ	PAFZZ	D	.008	5305-00-984-6193	SCREW, MACHINE: TERMINAL BOARD MTG MS35206-245 96906	EA	4	15
8	61	XBOZZ	PAOZZ	PAHZZ	PAFZZ			5940-00-983-6105	TERMINAL BOARD 39TB10 81349	EA	1	1
8	62	PAOZZ	PAOZZ	XBGZZ	PAFZZ	D	.010	6150-00-665-7230	JUMPER, TERMINAL 602J 75382 69-651-3 30554	EA	3	3
8	63	PAFZZ	PAOZZ	PAGZZ	PAFZZ	D	.008	5310-00-094-3421	NUT, WASHER ASSEMBLY: RELAY MTG 511-101800-00 78189 69-561-4 30554	EA	4	8
8	64	PAFZZ	PAOZZ	PAGZZ	PAFFF		.700	6110-00-202-2888	RELAY ASSEMBLY 69-765 30554 30554-69-765 36024	EA	1	1
8	65	PAFZZ	PAOZZ	PAGZZ	PAFZZ		.050	5910-00-879-3478	CAPACITOR MS39016/02-1240 81349	EA	1	1
8	66	PAFZZ	PAOZZ	PAGZZ	PAFZZ	D	.008	5310-00-094-3421	NUT, WASHER ASSEMBLY 511-101800-0 78189 69-561-4 30554	EA	8	8

(1) ILLUSTRATION		(2) SMR CODE				(3)		(4)	(5)	(6)	(7)	(8)
A	B	A	B	C	D	A	B	NATIONAL STOCK NUMBER	DESCRIPTION	USABLE ON CODE	QTY INC IN UNITS	USMC QTY PER EQUIP
FIG. NO.	ITEM NO.	ARMY	AIR FORCE	NAVY	USMC	SSI	REPL FACTOR		REF NUMBER & MFR CODE	U/M		
8	67	PAFZZ	PAOZZ	PAOZZ	PAFZZ	D	.010	5310-00-809-8546	WASHER, FLAT MS27183-8 96909	EA	4	4
8	68	PAFZZ	PAOZZ	PAGZZ	PAFZZ	D	.008	5305-00-984-4982	SCREW MACHINE M535208-225 96906	EA	4	12
8	69	XBFZZ	PAOZZ	PAHZZ	XBFZZ			5940-00-088-6357	BOARD, TERMINAL 42TB6 81349	EA	2	2
8	70	PAFZZ	PAOZZ	PAGZZ	PAFZZ	D	.010	5310-00-045-4007	WASHER, LOCK M3533-841 96906	EA	4	41
8	71	PAFZZ	PAOZZ	PAHZZ	PAFZZ		.050	5945-00-435-1833	RELAY M57523-003 81349	EA	2	6
8	72	XBFZZ	PAOZZ	XBGZZ	PAFZZ		.050	5935-00-206-1400	SOCKET, RELAY 69-658 30554 VB8-1 FALL-80 05574	EA	2	5
8	73	PAFZZ	PAOZZ	PAGZZ	PAFZZ		.040	5905-00-973-9226	RESISTOR, FIXED RW68V152 81349	EA	1	1
8	74	PAFZZ	PAOZZ	PAGZZ	PAFZZ		.040	5961-00-135-6168	RECTIFIER 69-739 30554 B-598-40 06288	EA	1	2
8	75	XBFZZ	XA	XBHZZ	XAFZZ				PC BOARD 69-764 30554 30554-69-764 36024	EA	1	1
8	76	PAOZZ	PAOZZ	PAOZZ	PAFZZ	D	.008	5310-00-063-7360	NUT WASHER ASSEMBLY 69-561-2 30554 511-061800-00 78189	EA	6	51
8	77	PAOZZ	PAOZZ	XBGZZ	PAFZZ			5305-00-984-4988	SCREW, MACHINE: DOOR MTG M535206-228 96906	EA	6	6
8	78	XBOZZ	XA	XBGZZ	XBFZZ				DOOR, CONTROL BOX 69-592 30554 30554-69-592 36024	EA	1	1
8	79	XBOZZ	XC	XBGZZ	XBFZZ				BOX, CONTROL 69-591 30554 30554-69-591 36024	EA	1	1
8	80	PAOZZ	PAOZZ	PAGZZ	PAFZZ	D	.030	2990-00-614-6785	SPEED CONTROL 73-2279-2 30554 73-2279-12IN 41625	EA	1	1
8	81	PAOZZ	PAOZZ	XBOZZ	XBFZZ		.010	5320-00-680-8779	RIVET, SOLID AN427-4C6 88044	EA	6	6
8	82	XBOZZ	PAOZZ	XBOZZ	XBFZZ			5340-01-053-7130	HINGE MS35823-6C 96906	EA	3	3
8	83	XBOZZ	MOO	XBOZZ	XBFZZ				SPACER 69-591-7 30554	EA	2	2
8	84	PAOZZ	PAOZZ	XBOZZ	XBFZZ		.008	5320-00-241-6020	RIVET, SOLID MS20427-4C4 96906	EA	6	6
8	85	PAOZZ	PAOZZ	XBOZZ	PAFZZ	D	.008	5325-00-449-2967	RECEPTACLE, TURNLOCK 9947P130 60119 69-693-2 30554	EA	3	3
8	86	PAOZZ	PAOZZ				.050	5355-00-538-7331	KNOB, SW, VOLT MS25166-1 96906	EA	1	1

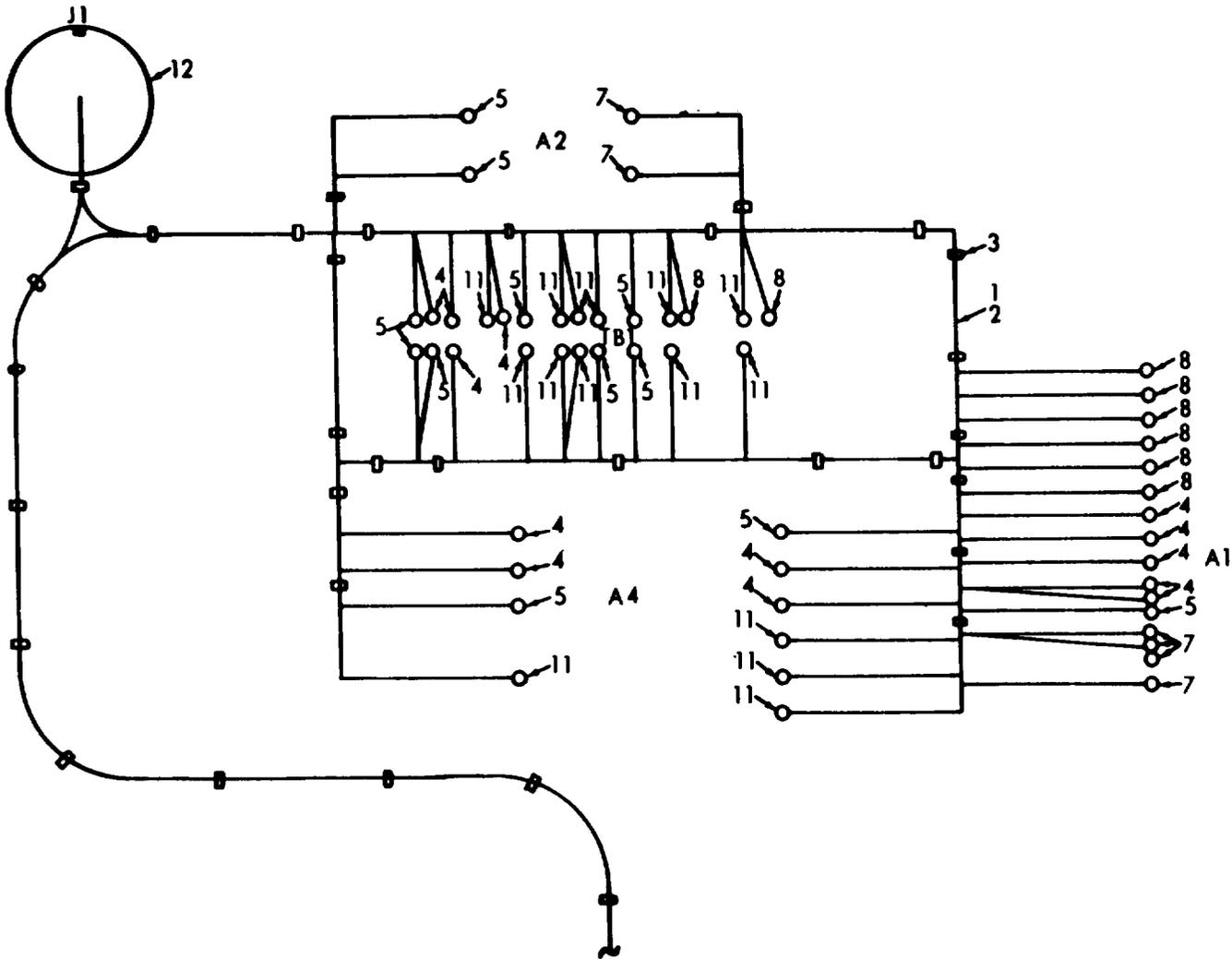

Figure 9. Control cubicle branched wiring harness. (sheet 1 of 2) (Landscape)

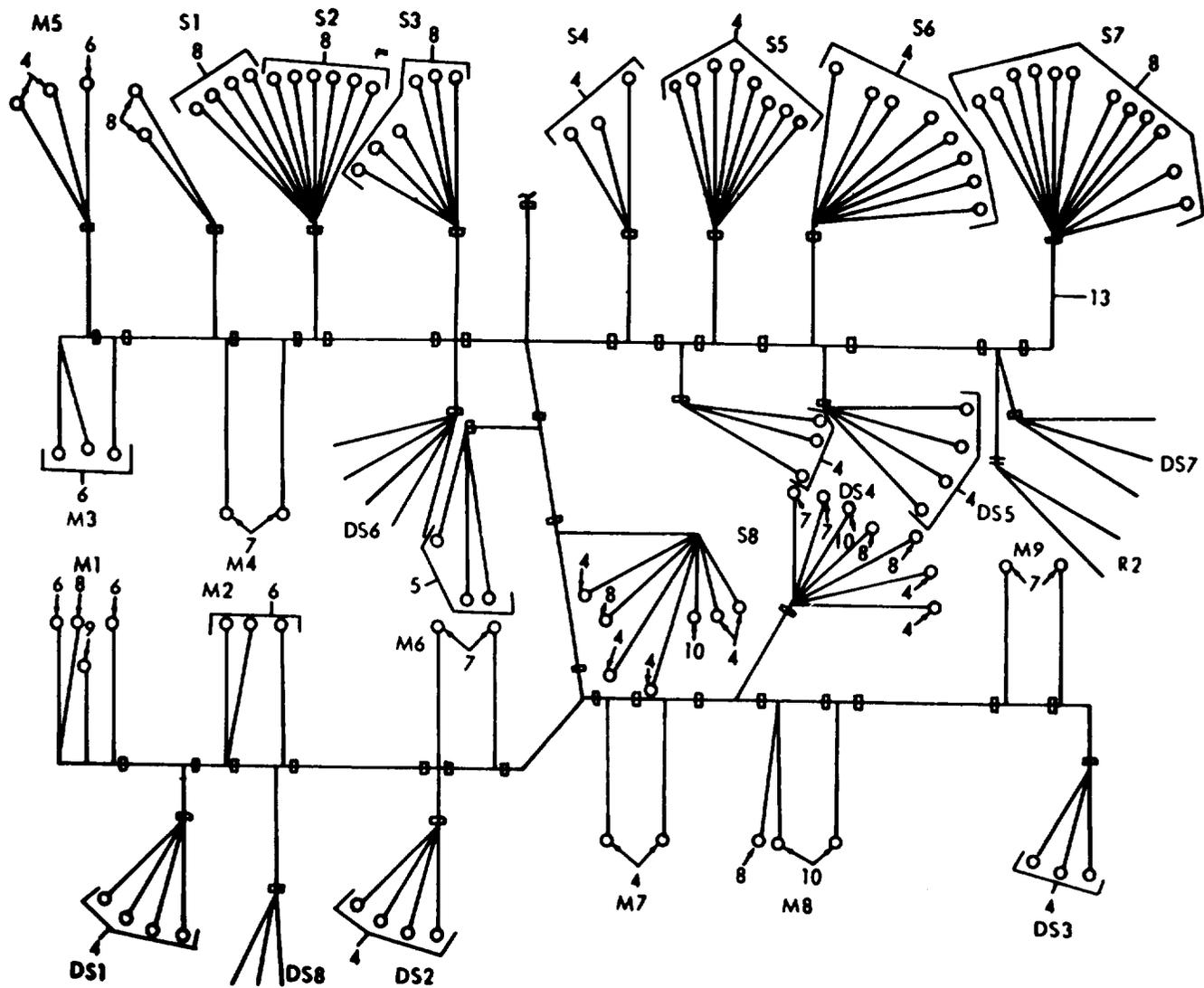

Figure 9. Control cubicle branched wiring harness. (sheet 2 of 2) (Landscape)

TM9-6115-465-24P
 TO 35C2-3-446-4
 NAVFAC P-8-625-24P
 SL-4-06858B/06859D

(1) ILLUSTRATION		(2) SMR CODE				(3)		(4) NATIONAL STOCK NUMBER	(5) DESCRIPTION	(6) USABLE ON CODE	(7) QTY INC IN UNITS	(8) USMC QTY PER EQUIP
A FIG. NO.	B ITEM NO.	A ARMY	B AIR FORCE	C NAVY	D USMC	A SSI	B REPL FACTOR	REF NUMBER & MFR CODE	U/M			
9		MFOOF	PBOFF	PBGGG	AFFZZ			6115-00-279-3198	WIRING HARNESS CONTROL CUBICLE 69-677 30554 30554-69-677 36024 MANUFACTURE FROM	EA	1	1
9	1	PAOZZ	PAOZZ	PAGZZ	PAFZZ	D	.080	6145-00-578-6605	WIRE, ELECTRICAL M5086/2-16-9 81349	FT	79	490
9	2	PAOZZ	PAOZZ	PAGZZ	PAFZZ	D	.080	6145-00-578-6602	WIRE, ELECTRICAL M5086/2-18-9 18349	FT	102	232
9	3	PAOZZ	PAOZ	PAGZZ	PAFZZ	D	.008	5975-00-074-2072	STRAP, CABLE MS33621-9 96906	EA	35	195
9	4	PAOZZ	PAOZZ	PAGZZ	PAFZZ	D	.050	5940-00-204-8966	TERMINAL, LUG MS25036-102 96906	EA	62	381
9	5	PAOZZ	PAOZZ	PAGZZ	PAFZZ	D	.050	5940-00-557-1629	TERMINAL, LUG MS25036-149 96906	EA	19	33
9	6	PAOZZ	PAOZZ	PAGZZ	PAFZZ	D	.050	5940-00-143-4771	TERMINAL, LUG MS25036-103 96906	EA	8	8
9	7	PAOZZ	PAOZZ	PAGZZ	PAFZZ	D	.050	5940-00-113-8184	TERMINAL, LUG MS25036-150 96906	EA	8	9
9	8	PAOZZ	PAOZ	PAGZZ	PAFZZ	D	.050	5940-00-283-5280	TERMINAL, LUG MS25036-106 96906	EA	39	175
9	9	PAOZZ	PAOZZ	PAGZZ	PAFZZ	D	.050	5940-00-143-4780	TERMINAL, LUG MS25036-108 96906	EA	2	15
9	10	PAOZZ	PAOZZ	PAGZZ	PAFZZ	D	.050	5940-00-230-0515	TERMINAL, LUG MS25036-154 96906	EA	3	4
9	11	PAOZZ	PAOZZ	PAGZZ	PAFZZ	D	.050	5940-00-143-4774	TERMINAL, LUG MS25036-153 96906	EA	18	25
9	12	PAFZZ	PAOZZ	PAGZZ	PAFZZ	D	.023	5935-00-844-4467	CONNECTOR, RECPTACLE 69-661-14 30554 MS3102R36-7P 96906	EA	1	2
9	13	PAOZZ	PAOZZ	XBGZZ	PAFZZ	D	.008	5970-00-954-1622	INSULATION, SLEEVING M23053/5-105-0 81349	FT	V	V

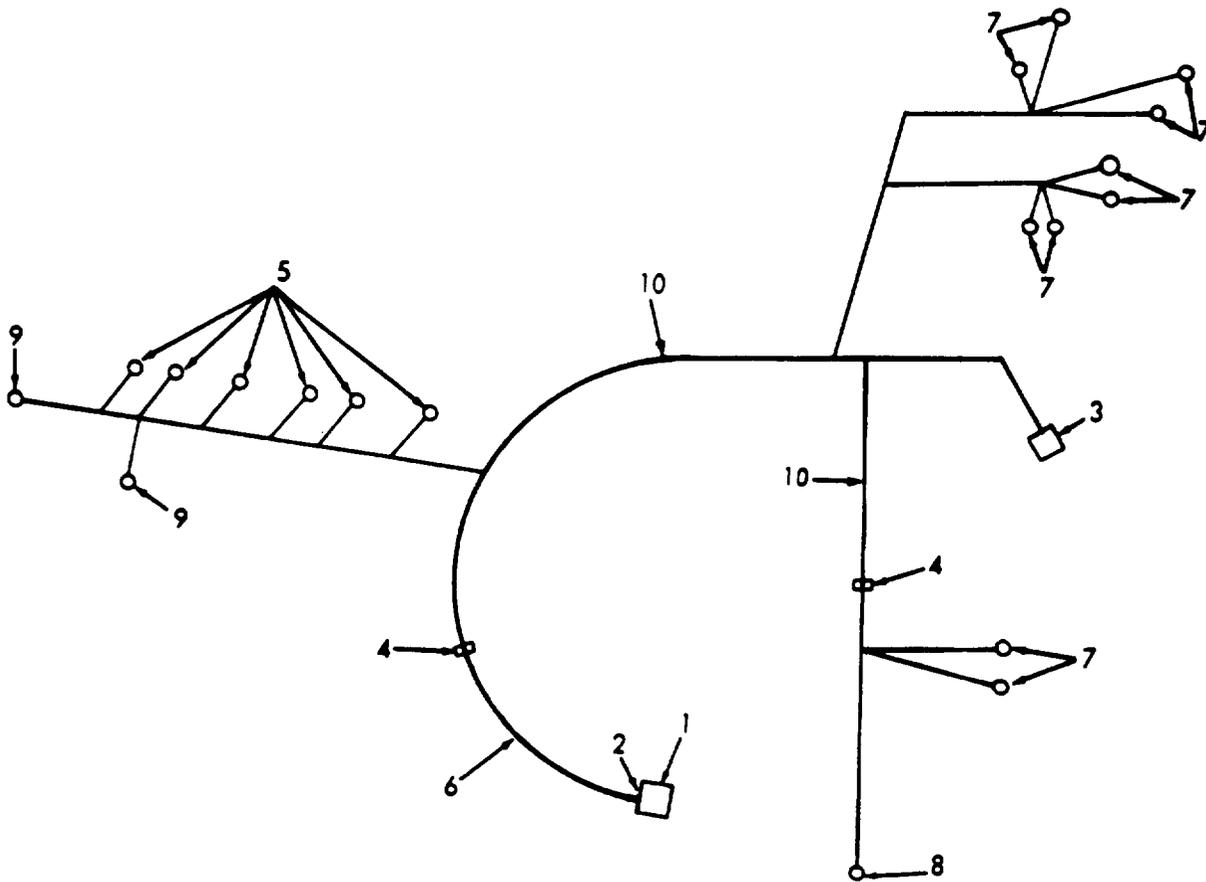

Figure 10. AC power control wiring harness.

TM9-6115-465-24P
 TO 35C2-3-446-4
 NAVFAC P-8-625-24P
 SL-4-06858B/06859D

(1) ILLUSTRATION A	(2) SMR CODE A	B	C	D	(3)		(4) NATIONAL STOCK NUMBER	(5) DESCRIPTION	(6) USABLE ON CODE	(7) QTY INC IN UNITS	(8) USMC QTY PER EQUIP	
					A	B						
FIG. NO.	ITEM NO.	ARMY	AIR FORCE	NAVY	USMC	SSI	B REPL FACTOR	REF NUMBER & MFR CODE	U/M			
10		MFOFF	PAOZZ	PBGGG	AFFZZ			6115-01-021-2164		EA	1	1
								WIRING HARNESS:AC POWER CONTROL 72-229 30554 30554-72-2259 36024 MANUFACTURE FROM				
10	1	PAFZZ	PAOZZ	PAGZZ	PAFZZ	D	.023	5935-00-851-9080	CONNECTOR, PLUG MS3106R32-7S 96906	EA	1	1
10	2	PAFZZ	PAOZZPAG:PAFZZ			D	.008	5935-00-823-5322	PLUG, END SEAL MS25251-16 96906	EA	1	54
10	3	PAFZZ	PAOZZ	PAGZZ	PAFZZ	D	.003	5935-00-726-8233	CONNECTOR MS3106R20-29S 96906	EA	1	3
10	4	PAFZZ	PAOZZ	PAGZZ	PAFZZ	D	.008	5975-00-727-5153	STRAP, CABLE MS3367-4-9 96906	EA	65	189
10	5	PAFZZ	PAOZZ	PAOZZ	PAFZZ	D	.050	5940-00-143-4474	TERMINAL, LUG MS25036-153 96906	EA	8	25
10	6	PAFZZ	PAOZZ	PAGZZ	PAFZZ	D	.080	6145-00-578-6605	WIRE, ELECTRICAL M5088-2-16-9 81349	FT	71	490
10	7	PAFZZ	PAOZZ	PAGZZ	PAFZZ	D	.050	5940-00-143-4793	TERMINAL, LUG MS25036-110 96906	EA	10	11
10	8	PAFZZ	PAOZZ	PAGZZ	PAFZZ	D	.050	5940-00-113-8183	TERMINAL, LUG MS25036-113 96906	EA	1	1
10	9	PAFZZ	PAOZZ	PAGZZ	PAFZZ	D	.050	5940-00-143-4780	TERMINAL, LUG MS25036-108 96906	EA	2	15
10	10	PAFZZ	PAOZZ	PAGZZ	PAFZZ	D	.080	6145-00-578-7514	WIRE, ELECTRICAL M5086/2-12-9 81349	FT	6	49

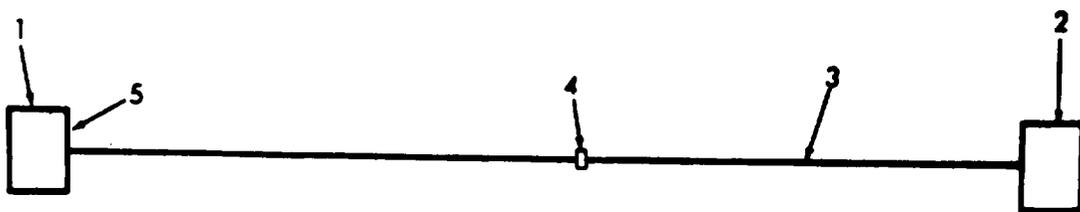

Figure 11. Fault locating indicator to special relay wiring harness.

TM9-6115-465-24P
 TO 35C2-3-446-4
 NAVFAC P-8-625-24P
 SL-4-06858B/06859D

(1) ILLUSTRATION A	(2) SMR CODE A	B	C	D	(3) A	B	(4) NATIONAL STOCK NUMBER	(5) DESCRIPTION REF NUMBER & MFR CODE	USABLE ON CODE	(6) U/M	(7) QTY INC IN UNITS	(8) USMC QTY PER EQUIP
	MFDFP	AOO	AGGGG	AFFZZ				WIRING HARNESS: FAULT LOCATING INDICATOR TO SPECIAL RELAY 72-2247 30554 30554-72-2247 36024 MANUFACTURE FROM:		EA	1	1
11	1	PAFZZ	PAOZZ	PAGZZ	PAFZZ	D	.023 5935-00-755-3144	CONNECTOR, PLUG MS3106R20-27P 96906		EA	1	1
11	2	PAFZZ	PAOZZ	PAGZZ	PAFZZ	D	.023 5935-00-846-2329	CONNECTOR, PLUG MS3106R20-27S 96906		EA	1	1
11	3	PAFZZ	PAOZZ	PAGZZ	PAFZZ	D	.080 6145-00-578-6605	WIRE, ELECTRICAL M5086-2-16-9 81349		FT	34	490
11	4	PAFZZ	PAOZZ	PAGZZ	PAFZZ	D	.008 5975-00-111-3208	STRAP, CABLE MS3367-5-9 96906		EA	9	232
11	5	PAFZZ	PAOZZ	PAGZZ	PAFZZ	D	.008 5935-00-823-5322	PLUG, END SEAL MS25251-16 96906		EA	2	54

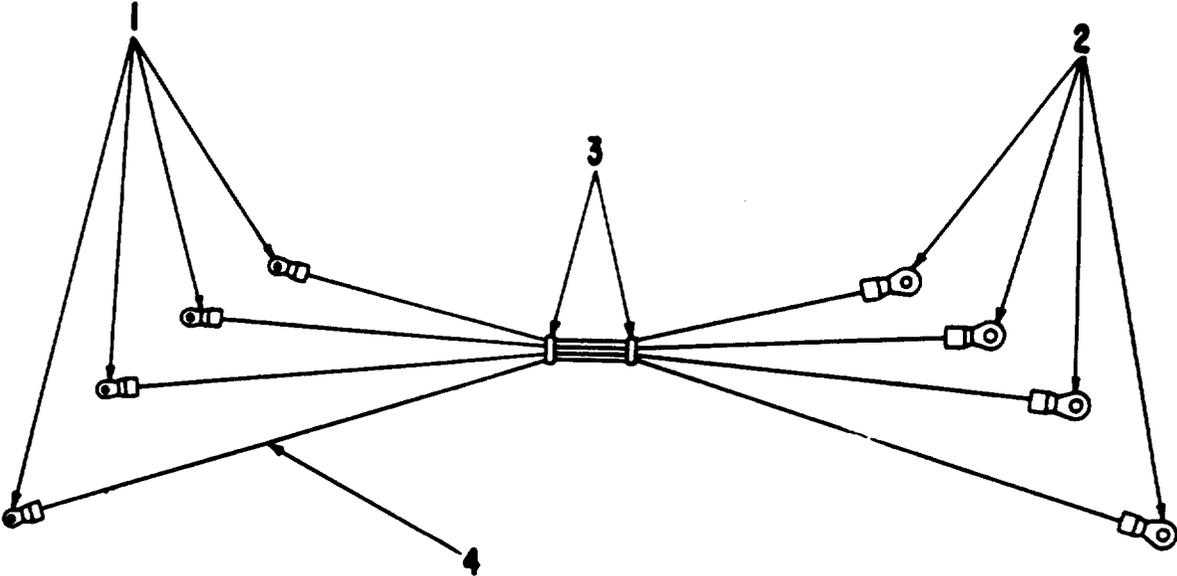

Figure 12. RFI capacitors wiring harness.

TM9-6115-465-24P
 TO 35C2-3-446-4
 NAVFAC P-8-625-24P
 SL-4-06858B/06859D

(1) ILLUSTRATION		(2) SMR CODE				(3)		(4) NATIONAL STOCK NUMBER	(5) DESCRIPTION	(6) USABLE ON CODE	(7) QTY INC IN UNITS	(8) USMC QTY PER EQUIP
A FIG. NO.	B ITEM NO.	A ARMY	B AIR FORCE	C NAVY	D USMC	A SSI	B REPL FACTOR	REF NUMBER & MFR CODE	U/M			
12		MFFZZ	AFO		AFFZZ			WIRING HARNESS: RFI CAPACITORS 77-501 30554 MANUFACTURED FROM:	EA	1	1	
12	1	PAFZZ	PAOZZ		PAFZZ	D	.050	5940-00-143-4774	TERMINAL LUG MS25036-153 96906	EA	4	41
12	2	PAFZZ	PAOZZ		PAFZZ	D	050	5940-00-660-3633	TERMINAL LUG MS25036-155 96906	EA	4	4
12	3	PAFZZ	PAOZZ		PAFZZ	D	.008	5975-00-111-3208	STRAP, CABLE MS3367-5-9 96906	EA	2	232
12	4	PAFZZ	PAOZZ		PAFZZ	D	.080	6145-00-578-6605	WIRE, ELECTRICAL M5086-2-16-9 81349	FT	5	490

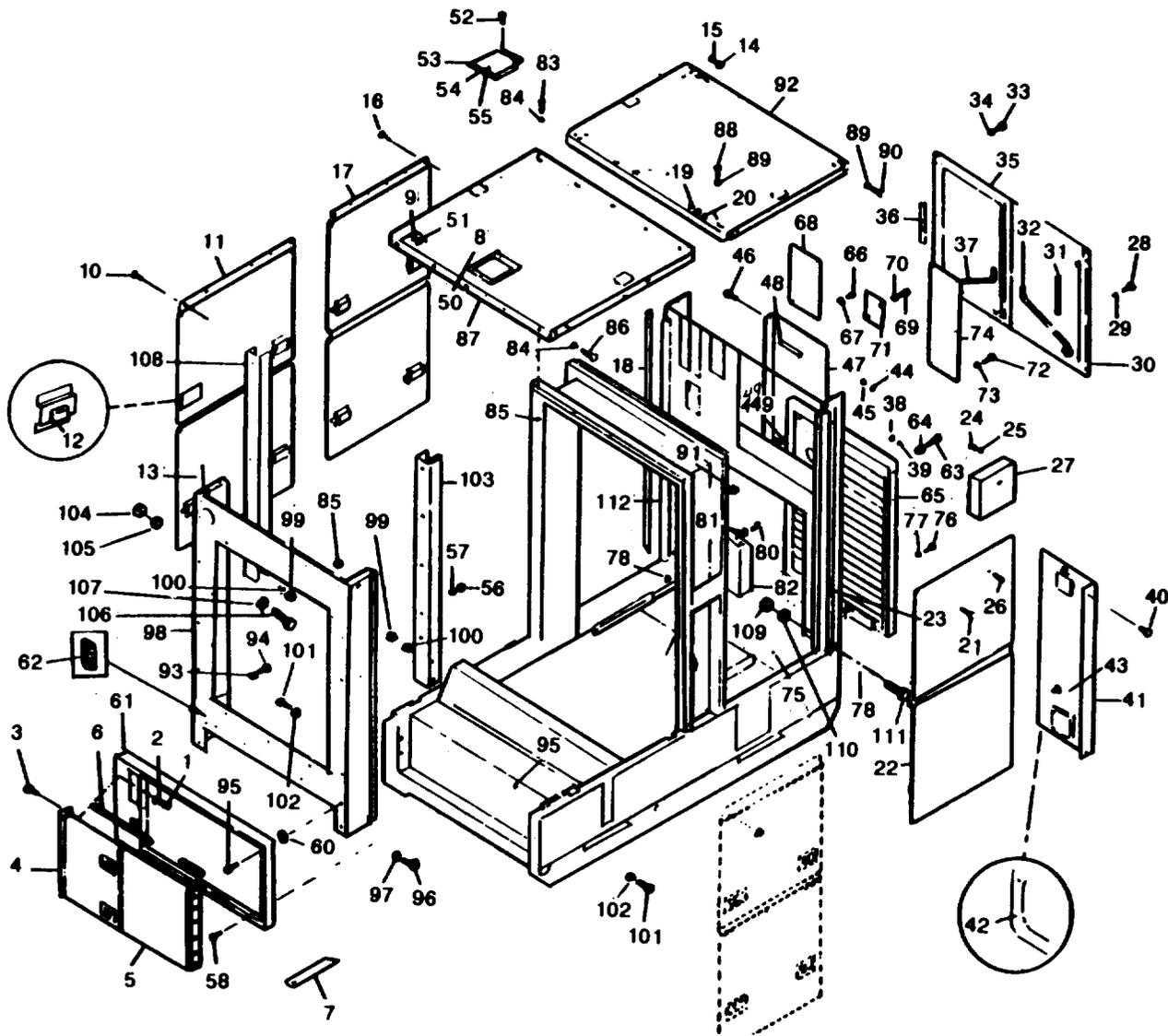

Figure 13. Housing Assembly. (Landscape)

(1) ILLUSTRATION A FIG. NO.	(2) SMR CODE A ITEM NO.	B AIR FORCE	C NAVY	D USMC	(3)		B REPL FACTOR	(4) NATIONAL STOCK NUMBER	(5) DESCRIPTION REF NUMBER & MFR CODE	(6) USABLE ON CODE U/M	(7) QTY INC IN UNITS	(8) USMC QTY PER EQUIP
					A	SSI						
GROUP 08-HOUSING												
13	1	PAOZZ	PAOZZ	PAOZZ	PAOZZ	D	.008	5310-00-761-6882	NUT,PLAIN,HEXAGON:BATTERY DOOR MTG MS51967-2 96906	EA	8	109
13	2	PAOZZ	PAOZZ	PAOZZ	PAOZZ	D	.010	5310-00-582-5965	WASHER,LOCK:BATTERY DOOR MTG MS35338-44 96906	EA	8	256
13	3	PAOZZ	PAOZZ	PAOZZ	PAOZZ	D	.008	5305-00-068-0500	SCREW,CAP,HEXAGON HEAD:BATTERY DOOR MTG MS90725-3 96906	EA	8	179
13	4	PFOZZ	PAOZZ	XBOZZ	PAOZZ			5340-01-194-2945	DOOR,BATTERY BOX:ACCESS LEFT 72-2176 30554 3554-72-2176 36024	EA	1	1
13	5	PFOZZ	PAOZZ	XBOZZ	PAOZZ			5310-01-197-1748	DOOR,BATTERY BOX:ACCESS RIGHT 72-2079 30554 30554-72-2079 36024	EA	1	1
13	6	PAOZZ	PAOZZ	PAOZZ	PAOZZ	D	.013	5330-00-036-6995	SEAL,DOOR:BATTERY 69-771 30554 RL2955 49944	FT	4	V
13	7	PAOZZ	PAOZZ	PAOZZ	PAOZZ	-	-	6115-01-151-7130	ROD,DOOR HOLDER 72-2138 30554 30554-72-2138 36024	EA	1	5
13	8	PAOZZ	PAOZZ	PAOZZ	PAOZZ	D	.008	5310-00-761-6882	NUT,PLAIN,HEXAGON:DOOR MTG MS51967-2 96906	EA	12	109
13	9	PAOZZ	PAOZZ	PAOZZ	PAOZZ	D	.010	5310-00-582-5965	WASHER,LOCK:DOOR MTG MS35338-44 96906	EA	12	256
13	10	PAOZZ	PAOZZ	PAOZZ	PAOZZ	D	.008	5305-00-068-0502	SCREW,CAP,HEXAGON HEAD:DOOR MTG MS90725-6 96906	EA	12	56
13	11	XBOFZ	XB	XBHZZ	PAOZZ	-	-	5340-01-198-7898	DOOR, FORWARD 72-2070 30554 30554-72-2070 36024	EA	2	2
13	12	XBOFZ						5340-00-229-3643	LOCK,PADDLE 69-657 30554	EA	2	16
13	13	PAOZZ	PAOZZ	PAOZZ	PAOZZ	D	.013	5330-00-036-6996	SEAL,DOOR 69-771 30554 RL2955 49944	FT	V	V
13	14	PAOZZ	PAOZZ	PAOZZ	PAOZZ	D	.008	5310-00-761-6882	NUT,PLAIN,HEXAGON:DOOR MTG MS51967-2 96906	EA	6	109
13	15	PAOZZ	PAOZZ	PAOZZ	PAOZZ	D	.010	5310-00-582-5965	WASHER,LOCK:DOOR MTG MS35338-44 96906	EA	6	256
13	16	PAOZZ	PAOZZ	PAOZZ	PAOZZ	D	.008	5305-00-068-0502	SCREW,CAP,HEXAGON HEAD MS90725-6 96906	EA	6	56
13	17	PFOZZ	PAOZZ	XBHZZ	PAOZZ	-	-	5340-01-216-0972	DOOR ASSEMBLY:REAR,RIGHT 72-2108 30554 30554-72-2108 36024	EA	1	1
13	18	PAOZZ	PAOZZ	PAOZZ	PAOZZ	D	.013	5330-00-036-6995	SEAL DOOR 69-771 30554 RL2955 49944	FT	9	V
13	19	PAOZZ	PAOZZ	PAOZZ	PAOZZ	D	.008	5310-00-761-6882	NUT,PLAIN,HEXAGON:DOOR MTG MS51967-2 96906	EA	6	109

(1) ILLUSTRATION		(2) SMR CODE				(3)		(4)	(5)	(6)	(7)	(8)
A	B	A	B	C	D	A	B	NATIONAL STOCK NUMBER	DESCRIPTION	USABLE ON CODE	QTY INC IN UNITS	USMC QTY PER EQUIP
FIG. NO.	ITEM NO.	ARMY	AIR FORCE	NAVY	USMC	SSI	REPL FACTOR	REF NUMBER & MFR CODE		U/M		
13	20	PAOZZ	PAOZZ	PAOZZ	PAOZZ	D	.010	5310-00-582-5965	WASHER, LOCK: DOOR MTG MS35338-44 96906	EA	6	256
13	21	PAOZZ	PAOZZ	PAOZZ	PAOZZ	D	.008	5305-00-068-0502	SCREW, CAP, HEXAGON HEAD: DOOR MTG MS90725-6 96906	EA	6	56
13	22	PBOFF	XB	XBOZZ	XBOZZ	-	-		DOOR, LEFT REAR 72-2134 30554 30554-72-2134 36024	EA	1	1
13	23	PAOZZ	PAOZZ	PAOZZ	PAOZZ	D	.013	5330-00-036-6995	SEAL, DOOR 69-771 30554 RL2955 49944	FT	V	V
13	24	PAOZZ	PAFZZ	PAOZZ	PAOZZ	D	.008	5310-00-880-7744	NUT, PLAIN, HEXAGON: DOCUMENT BOX MTG MS51967-5 96906	EA	3	24
13	25	PAOZZ	PAFZZ	PAOZZ	PAOZZ	D	.010	5310-00-407-9566	WASHER, LOCK: DOCUMENT BOX MTG MS35338-45 96906	EA	3	41
13	26	PAOZZ	PAFZZ	PAOZZ	PAOZZ	D	.008	5306-00-225-8497	BOLT, MACHINE: DOCUMENT BOX MTG MS90725-32 96906	EA	3	44
13	27	XBOFZ	XB	XBOZZ	XBOZZ	-	-		BOX, DOCUMENT 72-2142 30554 30554-72-2142 36024	EA	1	1
13	28	PAOZZ	PAFZZ	PAOZZ	PAOZZ	D	.008	5305-00-068-0500	SCREW, CAP, HEXAGON HEAD: DOOR MTG MS90725-3 96906	EA	3	179
13	29	PAOZZ	PAFZZ	PAOZZ	PAOZZ	D	.010	5310-00-582-5965	WASHER, LOCK: DOOR MTG MS35338-44 96906	EA	3	256
13	30	XBOFZ	XB	XBOZZ	XBOZZ	-	-		DOOR, CONTROL PANEL, LEFT 72-2074 30554	EA	1	1
13	31	PAOZZ	PAOZZ	PAOZZ	PAOZZ	D	.013	5330-00-036-6995	SEAL, DOOR 69-771 30554 RL2955 49944	FT	V	V
13	32	XBOZZ	MFO	XBOZZ	XBOZZ	-	-		ROD, DOOR HOLDER 72-2138 30554 30554-72-2138 36024	EA	1	5
13	33	PAOZZ	PAFZZ	PAOZZ	PAOZZ	D	.008	5305-00-068-0500	SCREW, CAP, HEXAGON HEAD: DOOR MTG MS90725-3 96906	EA	3	179
13	34	PAOZZ	PAFZZ	PAOZZ	PAOZZ	D	.010	5310-00-582-5965	WASHER, LOCK: DOOR MTG MS35338-44 96906	EA	3	256
13	35	XBOFZ	XB	XBOZZ	XBOZZ	-	-		DOOR, CONTROL PANEL, RIGHT 72-2073 30554 30554-72-2073 36024	EA	1	1
13	36	PAOZZ	PAFZZ	PAOZZ	PAOZZ	D	.013	5330-00-036-6995	SEAL, DOOR 69-771 30554 RL2955 49944	FT	V	V
13	37	XBOZZ	MFO	XBOZZ	XBOZZ	-	-		ROD, DOOR HOLDER 72-2138 30554 30554-72-2138 36024	EA	1	5
13	38	PAOZZ	PAFZZ	PAOZZ	PAOZZ	D	.008	5310-00-761-6882	NUT, PLAIN, HEXAGON: DOOR MTG MS51967-2 96906	EA	7	109
13	39	PAOZZ	PAFZZ	PAOZZ	PAOZZ	D	.010	5310-00-582-5965	WASHER, LOCK, DOOR MTG MS35338-44 96906	EA	7	256
13	40	PAOZZ	PAFZZ	PAOZZ	PAOZZ	D	.008	5305-00-068-0500	SCREW, CAP, HEXAGON HEAD: DOOR MTG MS90725-3 96906	EA	7	179

(1) ILLUSTRATION		(2) SMR CODE				(3)		(4) NATIONAL STOCK NUMBER	(5) DESCRIPTION	(6) USABLE ON CODE	(7) QTY INC IN UNITS	(8) USMC QTY PER EQUIP
A FIG. NO.	B ITEM NO.	A ARMY	B AIR FORCE	C NAVY	D USMC	A SSI	B REPL FACTOR	REF NUMBER & MFR CODE	U/M			
13	41	XBOFZ	XB	XBGZZ	XBOZZ	-	-	DOOR, LOUVER, LEFT 72-2074 30554 30554-72-2071 36024	EA	1	1	
13	42	PAOZZ	PAOZZ	PAOZZ	PAOZZ	D	.013	5330-00-036-6996 SEAL, DOOR 69-771 30554 RL2955 49944	FT	V	V	
13	43	XBOZZ	MFO	XBOZZ	XBOZZ	-	-	ROD, DOOR HOLDER 72-2138 30554 30554-72-2138 36024	EA	1	5	
13	44	PAOZZ	PAOZZ	PAOZZ	PAOZZ	D	.008	5310-00-761-6882 NUT, PLAIN, HEXAGON: DOOR MTG MS51967-2 96906	EA	7	109	
13	45	PAOZZ	PAOZZ	PAOZZ	PAOZZ	D	.010	5310-00-582-5965 WASHER, LOCK: DOOR MTG MS35338-44 96906	EA	7	256	
13	46	PAOZZ	PAOZZ	PAOZZ	PAOZZ	D	.008	5305-00-068-0502 SCREW, CAP, HEXAGON HEAD: DOOR MTG MS90725-6 96906	EA	7	56	
13	47	XBOFZ	XB	XBGZZ	XBOZZ	-	-	DOOR, LOWER, RIGHT 72-2072 30554 30554-72-7072 36024	EA	1	1	
13	48	PAOZZ	PAOZZ	PAOZZ	PAOZZ	D	.013	5330-00-036-6995 SEAL, DOOR 69-771 30554 RL2955 49944	FT	V	V	
13	49	XBOZZ	MFO	XBOZZ	XBOZZ	-	-	ROD, DOOR HOLDER 72-2138 30554 30554-72-2138 36024	EA	1	5	
13	50	PAOZZ	PAOZZ	PAOZZ	PAOZZ	D	.008	5310-00-761-6882 NUT, PLAIN, HEXAGON: RADIATOR FILL DOOR MTG MS51967-2 96906	EA	2	109	
13	51	PAOZZ	PAOZZ	PAOZZ	PAOZZ	D	.010	5310-00-582-5965 WASHER, LOCK: RADIATOR FILL DOOR MTG MS35338-44 96906	EA	2	256	
13	52	PAOZZ	PAOZZ	PAOZZ	PAOZZ	D	.008	5305-00-068-0500 SCREW, CAP, HEXAGON HEAD: RADIATOR FILL DOOR MTG MS90725-3 96906	EA	2	179	
13	53	XBOFZ	XB	XBFZZ	XBOZZ	-	-	DOOR, RADIATOR FILL 72-2121 30554 30554-72-2121 36024	EA	1	1	
13	54	PAFZZ	PAOZZ	XBOZZ	PAOZZ	D	.008	5310-00-822-8525 WASHER, SPLIT 70-1511 30554 85-34-101-20 94222	EA	21	1	
13	55	PAFZZ	PAOZZ	PAGZZ	PAOZZ	D	.008	5325-00-343-5531 FASTENER, DOOR 72-2283 30554 85-15-140-16 94222	EA	1	1	
13	56	PAOZZ	PAOZZ	PAOZZ	PAOZZ	D	.008	5310-00-761-6882 NUT, PLAIN, HEXAGON: DOOR FRAME MTG MS51967-2 96906	EA	9	109	
13	57	PAOZZ	PAOZZ	PAOZZ	PAOZZ	D	.010	5310-00-582-5965 WASHER, LOCK: DOOR FRAME MTG MS35338-44 96906	EA	12	256	
13	58	PAOZZ	PAOZZ	PAOZZ	PAOZZ	D	.008	5305-00-068-0500 SCREW, CAP, HEXAGON HEAD: DOOR FRAME MTG MS90725-3	EA	6	179	
13	59	PAOZZ	PAOZZ	PAOZZ	PAOZZ	D	.008	5305-00-068-0502 SCREW, CAP, HEXAGON HEAD: DOOR FRAME MTG MS90725-6 96906	EA	6	56	

(1) ILLUSTRATION		(2) SMR CODE				(3)		(4) NATIONAL STOCK NUMBER	(5) DESCRIPTION	(6) USABLE ON CODE	(7) QTY INC IN UNITS	(8) USMC QTY PER EQUIP
A FIG. NO.	B ITEM NO.	A ARMY	B AIR FORCE	C NAVY	D USMC	A SSI	B REPL FACTOR	REF NUMBER & MFR CODE	U/M			
13	60	PAOZZ	PAOZZ	PAOZZ	PAOZZ	D	.010	5310-00-823-8804 WASHER, PLAT: FRAME AND PANEL MTG MS27183-9 96906	EA	13	45	
13	61	XBOFZ	XB	ZBZZ	XBOZZ	-	-	FRAME, DOOR 72-2055 30554 30554-72-2055 36024	EA	1	1	
13	62	PAFZZ	PAOZZ		PAFZZ	D	.005	BOARD, TERMINAL MS27212-5-2 96906	EA	1	1	
13	63	PAOZZ	PAOZZ	PAOZZ	PAOZZ	D	.008	5305-00-068-0500 SCREW, CAP, HEXAGON HEAD: PANEL MTG MS90725-3 96906	EA	10	179	
13	64	PAOZZ	PAOZZ	PAOZZ	PAOZZ	D	.010	5310-00-582-5965 WASHER, LOCK: PANEL MTG MS35338-44 96906	EA	10	256	
13	65	XBOZZ	XB	XBZZ	XBOZZ	-	-	PANEL, AIR INTAKE 72-2080 30554 30554-72-2080 36024	EA	1	1	
13	66	PAOZZ	PAOZZ	PAOZZ	PAOZZ	D	.008	5305-00-068-0500 SCREW, CAP, HEXAGON HEAD: PANEL MTG MS90725-3 96906	EA	4	179	
13	67	PAOZZ	PAOZZ	PAOZZ	PAOZZ	D	.010	5310-00-582-5965 WASHER, LOCK: BLANK PANEL MTG MS35338-44 96906	EA	4	265	
13	68	XBOZZ	MFO	XBZZ	XBOZZ	-	-	PANEL, BLANK 72-2049 30554 30554-72-2049 36024	EA	1	1	
13	69	PAOZZ	PAOZZ	PAOZZ	PAOZZ	D	.008	5305-00-191-6226 SCREW AND CAPTIVE WASHER COVER PLATE MTG 69-662-64 30554 P15121-64 45722	EA	2	24	
13	70	PAOZZ	PAOZZ	PAOZZ	PAOZZ	D	.010	5310-00-934-9751 WASHER, LOCK: COVER PLATE MTG MS35650-302 96906	EA	6	19	
13	71	XBOZZ	MFO	XBZZ	XBOZZ	-	-	PLATE, COVER 72-2035 30554 30554-72-2035 36024	EA	1	1	
13	72	PAOZZ	PAOZZ	PAOZZ	PAOZZ	D	.008	5305-00-068-0500 SCREW, CAP, HEXAGON HEAD: PLATE MTG MS90725-3 96906	EA	6	179	
13	73	PAOZZ	PAOZZ	PAOZZ	PAOZZ	D	.010	5310-00-582-5965 WASHER, LOCK: COVER PLATE MTG MS35338-44 96906	EA	6	256	
13	74	XBOFZ	MFO	XBZZ	XBOZZ	-	-	PLATE, COVER 70-502 30554 30554-70-502 30624	EA	1	1	
13	75	PAOZZ	PAOZZ	PAOZZ	PAOZZ	D	.008	5310-00-761-6882 NUT, PLAIN, HEXAGON: REAR COVER MTG MS51967-2 96906	EA	2	10	
13	76	PAOZZ	PAOZZ	PAOZZ	PAOZZ	D	.008	5305-00-068-0500 SCREW, CAP, HEXAGON HEAD: REAR COVER MTG MS90725-3 96906	EA	4	179	
13	77	PAOZZ	PAOZZ	PAOZZ	PAOZZ	D	.010	5310-00-582-5965 WASHER, LOCK: REAR COVER MTG MS35338-44 96906	EA	4	256	
13	78	XBOFZ	XB	XBZZ	XBOZZ	-	-	COVER, REAR 72-2108 30554 30554-72-2106 30624	EA	1	1	
13	79	PAOZZ	PAOZZ	PAOZZ	PAOZZ	D	.008	5310-00-761-6882 NUT, PLAIN, HEXAGON: REAR COVER MTG MS51967-2 96906	EA	2	109	

(1) ILLUSTRATION A FIG. NO.	(2) SMR CODE B ITEM NO.	(3) A ARMY	(3) B AIR FORCE	(3) C NAVY	(3) D USMC	(3) E SSI	(4) NATIONAL STOCK NUMBER	(5) DESCRIPTION REF NUMBER & MFR CODE	(6) USABLE ON CODE U/M	(7) QTY INC IN UNITS	(8) USMC QTY PER EQUIP
13	80	PAOZZ	PAOZZ	PAOZZ	PAOZZ	D	.008 5305-00-068-0500	SCREW,CAP,HEXAGON HEAD:REAR COVER MTG MS90725-3 96906	EA	4	179
13	81	PAOZZ	PAOZZ	PAOZZ	PAOZZ	D	.010 5310-00-582-5965	WASHER,LOCK:REAR COVER MTG MS35338-44 96906	EA	4	156
13	82	XBOFZ	XB	XBGZZ	XBOZZ	-	-	COVER,REAR 72-2105 30554 30554-72-2105 36024	EA	1	1
13	83	PAOZZ	PAOZZ	PAOZZ	PAOZZ	D	.008 5305-00-068-0500	SCREW,CAP,HEXAGON HEAD: TOP MTG MS90725-3 96906	EA	10	179
13	84	PAOZZ	PAOZZ	PAOZZ	PAOZZ	D	.010 5310-00-532-5965	WASHER,LOCK:TOP MTG MS35338-44 96906	EA	16	256
13	85	PAOZZ	PAOZZ	PAOZZ	PAOZZ	D	.008 5310-00-761-6882	NUT,PLAIN,HEXAGON:TOP MTG MS51967-2 96906	EA	11	109
13	86	PAOZZ	PAOZZ	PAOZZ	PAOZZ	D	.008 5305-00-068-0502	SCREW,CAP,HEXAGON HEAD:TOP MTG MS90725-6 96906	EA	4	56
13	87	XBOFZ	XB	XBGZZ	XBOZZ	-	-	TOP,FRONT 72-2046 30554 30554-72-2046 36024	EA	1	1
13	88	PAOZZ	PAOZZ	PAOZZ	PAOZZ	D	.008 5305-00-068-0500	SCREW,CAP,HEXAGON HEAD:TOP MTG MS90725-3 96906	EA	10	179
13	89	PAOZZ	PAOZZ	PAOZZ	PAOZZ	D	.010 5310-00-582-5965	WASHER,LOCK:TOP MTG MS35338-44 96906	EA	14	256
13	90	PAOZZ	PAOZZ	PAOZZ	PAOZZ	D	.008 5305-00-068-0502	SCREW,CAP MS90725-6 96906	EA	4	56
13	91	PAOZZ	PAOZZ	PAOZZ	PAOZZ	D	.008 5310-00-761-6882	NUT,PLAIN,HEXAGON:TOP MTG MS51967-2 96906	EA	6	10
13	92	XBOFZ	XB	XBGZZ	XBOZZ	-	-	HOUSING TOP,REAR 72-2045 30554 30554-72-2045 36024	EA	1	1
13	93	PAOZZ	PAOZZ	PAOZZ	PAOZZ	D	.008 5305-00-068-0500	SCREW,CAP,HEXAGON:FRONT HOUSING MTG MS90725-3 96906	EA	6	179
13	94	PAOZZ	PAOZZ	PAOZZ	PAOZZ	D	.010 5310-00-582-5965	WASHER,LOCK:FRONT HOUSING TOP MTG MS35338-44 96906	EA	6	256
13	95	PAOZZ	PAOZZ	PAOZZ	PAOZZ	5	.008 5310-00-880-7744	NUT,PLAIN,HEXAGON: FRAME HOUSING MTG MS51967-5 96906	EA	6	24
13	96	PAOZZ	PAOZZ	PAOZZ	PAOZZ	D	.008 5306-00-225-8497	BOLT,MACHINE:FRONT HOUSING MTG MS90725-32 96906	EA	6	24
13	97	PAOZZ	PAOZZ	PAOZZ	PAOZZ	D	.010 5310-00-407-9566	WASHER,LOCK:FRONT HOUSING MTG MS35338-45 96906	EA	6	41
13	98	XBOFZ	XB	XBGZZ	XBOZZ	-	-	HOUSIN,FRONT 72-2009 30554 30554-72-2009 36024	EA	1	1
13	99	PAOZZ	PAOZZ	PAOZZ	PAOZZ	D	.008 5310-00-732-0538	NUT,PLAIN,HEXAGON: HOUSING BRACKET MTG,LEFT MS51967-5 96906	EA	4	24
13	100	PAOZZ	PAOZZ	PAOZZ	PAOZZ	D	.010 5310-00-637-9541	WASHER,LOCK:HOUSING BRACKET MTG,LEFT MS35338-46 96906	EA	4	104

(1) ILLUSTRATION		(2) SMR CODE				(3)		(4) NATIONAL STOCK NUMBER	(5) DESCRIPTION	(6) USABLE ON CODE	(7) QTY INC IN UNITS	(8) USMC QTY PER EQUIP
A FIG. NO.	B ITEM NO.	A ARMY	B AIR FORCE	C NAVY	D USMC	A SSI	B REPL FACTOR	REF NUMBER & MFR CODE	U/M			
13	101	PAOZZ	PAOZZ	PAOZZ	PAOZZ	D	.008	5305-00-269-3209	SCREW,CAP,HEXAGON HEAD: HOUSING BRACKET MTG LEFT MS90725-58 96906	CLA,CLB CLC,DGG	EA	4 18
13	101	PAOZZ	PAOZZ		PAOZZ	D	.008	5305-00-269-3211	SCREW,CAP,HEXAGON HEAD HOUSING BRACKET MTG LEFT MS90725-60 96906	CZN,CZM	EA	4 4
13	102	PAOZZ	PAOZZ	PAOZZ	PAOZZ	D	.010	5310-00-080-6004	WASHER,FLAT: HOUSING BRACKET MTG,LEFT MS27183-14 96906		EA	4 18
13	103	XBOFZ	MFO	XBFZZ	XBOZZ	-	-		BRACKET,HOUSING,LEFT 72-2095 30554 30554-72-2095 36024		EA	1 1
13	104	PAOZZ	PAOZZ	PAOZZ	PAOZZ	D	.008	5310-00-732-0558	NUT,PLAIN,HEXAGON:HOUSING BRACKET MTG,RIGHT MS51967-8 96906		EA	4 24
13	105	PAOZZ	PAOZZ	PAOZZ	PAOZZ	D	.010	5310-00-637-9541	WASHER,LOCK:HOUSING BRACKET MTG,RIGHT MS35338-46 96906		EA	4 104
13	106	PAOZZ	PAOZZ	PAOZZ	PAOZZ	D	.008	5305-00-269-3209	SCREW,CAP,HEXAGON HEAD:HOUSING BRACKET MTG,RIGHT MS90725-58 96906		EA	4 18
13	107	PAOZZ	PAOZZ	PAOZZ	PAOZZ	D	.010	5310-00-080-6004	WASHER,FLAT:HOUSING BRACKET MTG,RIGHT MS27183-14 96906		EA	4 18
13	108	XBOFZ	MFO	XBGZZ	XBOZZ	-	-		BRACKET,HOUSING,RIGHT 72-2096 30554 30554-72-2096 36024		EA	1 1
13	109	PAOZZ	PAOZZ	PAOZZ	PAOZZ	D	.008	5310-00-880-7744	NUT,PLAIN,HEXAGON:REAR HOUSING MTG MS51967-5 96906		EA	4 24
13	110	PAOZZ	PAOZZ	PAOZZ	PAOZZ	D	.010	5310-00-407-9566	WASHER,LOCK:REAR HOUSING MTG MS35338-45 96906		EA	4 41
13	111	PAOZZ	PAOZZ	PAOZZ	PAOZZ	D	.008	5306-00-225-8497	BOLT,MACHINE:REAR HOUSING MTG MS90725-32 96906		EA	4 44
13	112	XBOFZ	XB	XBGZZ	XBOZZ	-	-		HOUSING,REAR 72-2038 30554 30554-72-2038 36024		EA	1 1

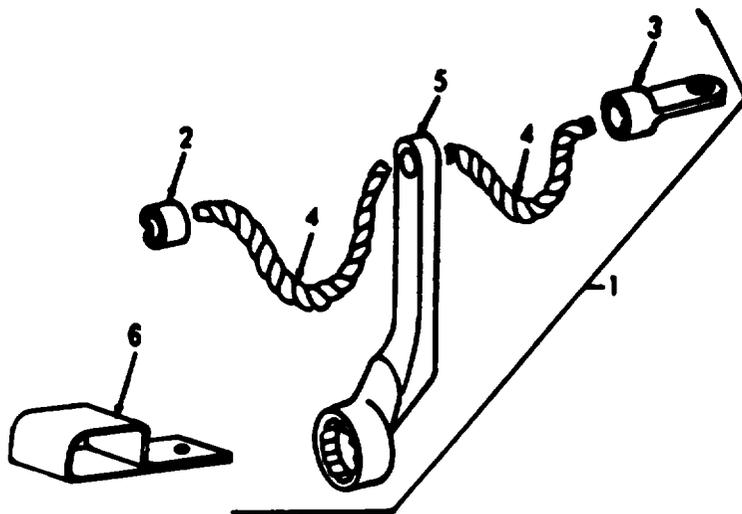

Figure 14. Cord and wrench assembly.

TM9-6115-465-24P
 TO 35C2-3-446-4
 NAVFAC P-8-625-24P
 SL-4-06858B/06859D

(1) ILLUSTRATION		(2) SMR CODE				(3)		(4) NATIONAL STOCK NUMBER	(5) DESCRIPTION	(6) USABLE ON CODE	(7) QTY INC IN UNITS	(8) USMC QTY PER EQUIP
A FIG. NO.	B ITEM NO.	A ARMY	B AIR FORCE	C NAVY	D USMC	A SSI	B REPL FACTOR	REF NUMBER & MFR CODE	U/M			
14	1	AFOZZ	AOO	XBOZZ	MOOZZ	-	-		CORD AND WRENCH ASSMEBLY 72-2118-2 30554 30554-72-2118-2 36024	EA	1	
14	2	PAOZZ	PAOZZ	PAOZZ	PAOZZ	D	.050	5940-00-115-2678	LUG,TERMINAL MS20659-11 96906	EA	2	1
14	3	PAOZZ	PAOZZ	PAOZZ	PAOZZ	-	-	5940-00-853-3987	SPLICE, CONDUCTOR 72-2042 30554 264-2 59730	EA	1	V
14	4	PAOZZ	PAOZZ	XBOZZ	PAOZZ	D	.123	4020-00-928-3438	ROPE,NYLON 1/4 IN.DIA. X 28 IN.LONG MIL-R-17343 81349	FT	V	V
14	5	PAOZZ	PAOZZ	XBOZZ	PAOZZ	D	.009	5120-00-138-3790	WRENCH,LOAD TERMINAL 72-2029-2 3-554	EA	1	1
14	6	XBOZZ	PAOZZ	XBZZ					BRACKET,WRENCH 72-2136 30554	EA	1	1

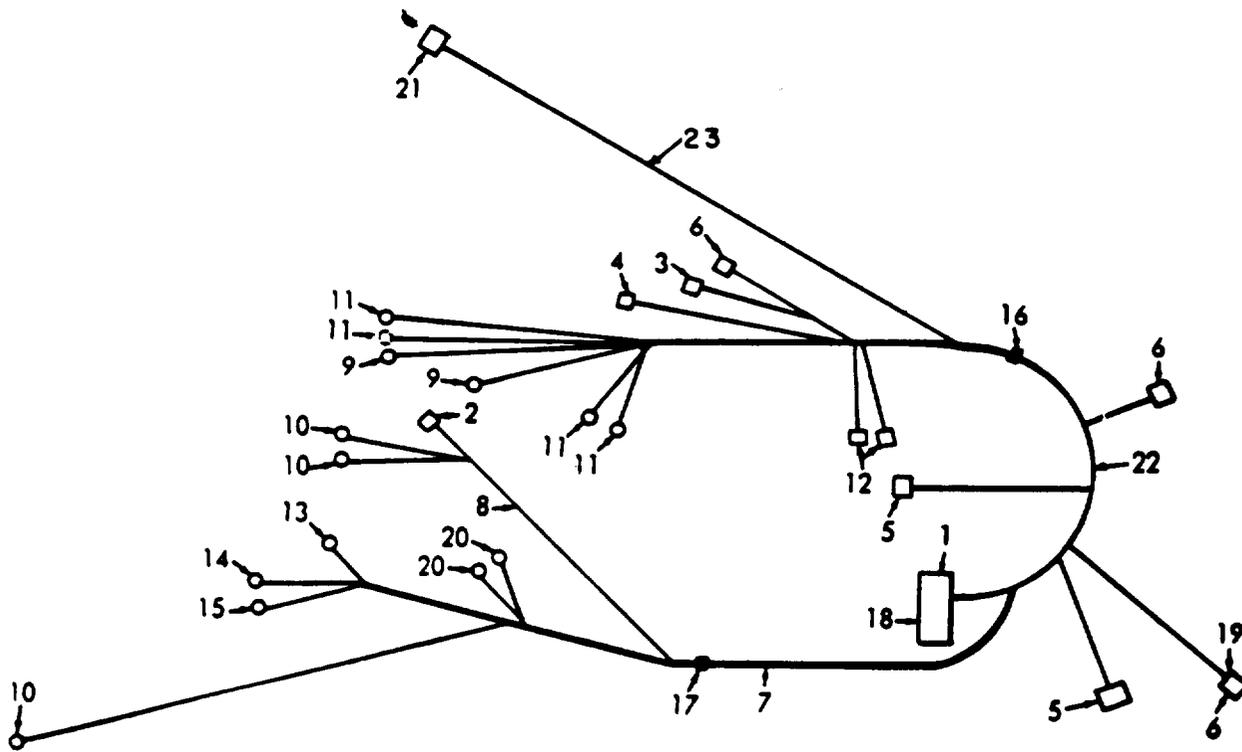
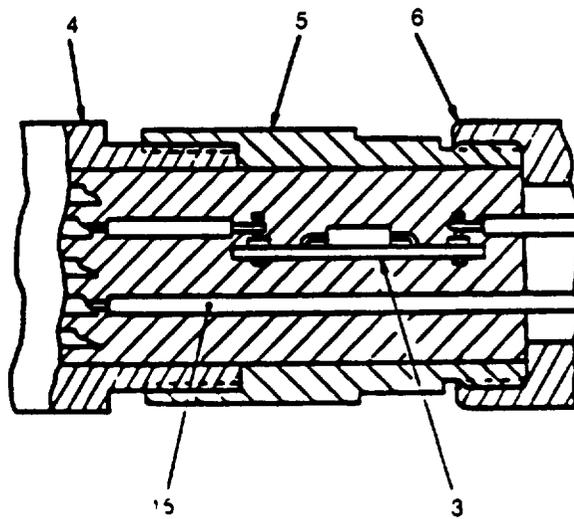
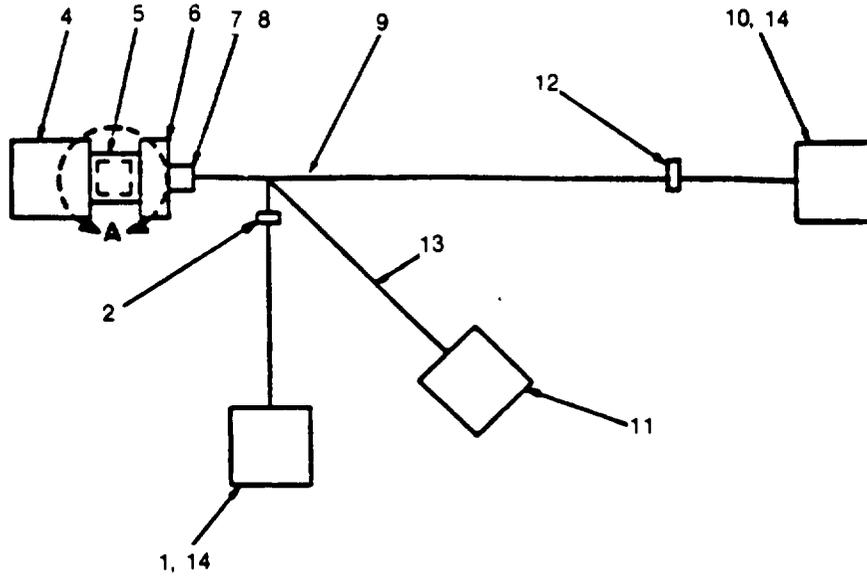

Figure 15. Engine wiring harness.

(1) ILLUSTRATION A FIG. NO.	(2) SMR CODE A B ITEM NO.	A	B AIR FORCE	C	D	(3)		(4) NATIONAL STOCK NUMBER	(5) DESCRIPTION REF NUMBER & MFR CODE	(6) USABLE ON CODE	(7) QTY INC IN UNITS	(8) USMC QTY PER EQUIP
						A	B SSI					
GROUP 09-WIRING HARNESES												
15		MFOFF	PAOZZ	PBGGG	AFFZZ	-	-	6115-01-007-6957	WIRING HARNESS 72-2284 30554 30554-72-2284 36024 MANUFACTURE FROM:	EA	1	1
15	1	PAFZZ	PAOZZ	PAGZZ	PAFZZ	D	.023	5935-00-723-5281	CONNECTOR, PLUG MS3106R36-7S 96906	EA	1	2
15	2	PAFZZ	PAOZZ	PAGZZ	PAFZZ	D	.023	5935-00-845-1701	CONNECTOR, PLUG MS3106R18-5P 96906	EA	1	1
15	3	PAFZZ	PAOZZ	PAGZZ	PAFZZ	D	.023	5935-00-813-4717	CONNECTOR, PLUG MS3108R14S 96906	EA	1	1
15	4	PAFZZ	PAOZZ	PAGZZ	PAFZZ	D	.023	5935-00-189-3932	CONNECTOR, PLUG MS3106F18-1S 96906	EA	1	1
15	5	PAFZZ	PAOZZ	PAGZZ	PAFZZ	D	.023	5935-00-553-3094	CONNECTOR, PLUG MS3106E14S2SC 96906	EA	2	2
15	6	PAFZZ	PAOZZ	XBGZZ	PAFZZ	D	.023	5935-00-432-8967	CONNECTOR, PLUG MS3106R10SL4S 90609 MB723/23R1104N 81349	EA	3	4
15	7	PAFZZ	PAOZZ	PAGZZ	PAFZZ	D	.080	6145-00-578-7514	WIRE, ELECTRICAL MS086-2-12-9 81349	FT	32	49
15	8	PAFZZ	PAOZZ	PAGZZ	PAFZZ	D	.080	6145-00-578-6605	WIRE, ELECTRICAL MS086-2-16-9 81349	FT	106	490
15	9	PAFZZ	PAOZZ	PAGZZ	PAFZZ	D	.050	5940-00-143-4780	TERMINAL, LUG MS25036-108 96906	EA	2	15
15	10	PAFZZ	PAOZZ	PAOZZ	PAFZZ	D	.050	5940-00-143-4774	TERMINAL, LUG MS25036-153 96906	EA	3	25
15	11	PAFZZ	PAOZZ	PAGZZ	PAFZZ	D	.050	5940-00-143-4775	TERMINAL, LUG MS25036-156 96906	EA	4	9
15	12	PAFZZ	PAOZZ	PAGZZ	PAFZZ	D	.023	5935-00-167-7775	CONNECTOR MS27144-1 96906	EA	2	2
15	13	PAFZZ	PAOZZ	PAGZZ	PAFZZ	D	.050	5940-00-143-4794	TERMINAL, LUG MS25036-112 96906	EA	1	3
15	14	PAFZZ	PAOZZ	PAGZZ	PAFZZ	D	.050	5940-00-113-9826	TERMINAL, LUG MS25036-114 96906	EA	1	1
15	15	PAFZZ	PAOZZ	PAGZZ	PAFZZ	D	.050	5940-00-143-4793	TERMINAL, LUG MS25036-110 96906	EA	1	11
15	16	PAFZZ	PAOZZ	PAGZZ	PAFZZ	D	.008	5975-00-074-2072	STRAP, CABLE MS3367-1-9 96906	EA	73	195
16	17	PAFZZ	PAOZZ	PAGZZ	PAFZZ	D	.008	5975-00-11-3208	STRAP, CABLE MS3367-5-9 96906	EA	73	232
15	18	PAFZZ	PAOZZ	PAGZZ	PAFZZ	D	.008	5935-00-823-5322	SEAL, PLUG MS25261-16 96906	EA	7	54
15	19	PAFZZ	PAOZZ	PAGZZ	PAFZZ	D	.008	5935-00-566-9503	PLUG, END SEAL MS25251-12 96906	EA	2	6
15	20	PAFZZ	PAOZZ	PAGZZ	PAFZZ	D	.050	5940-00-817-5556	TERMINAL, LUG 72-2133 30554 C177 59730	EA	2	2

TM9-6115-465-24P
 TO 35C2-3-446-4
 NAVFAC P-8-625-24P
 SL-4-06858B/06859D

(1) ILLUSTRATION		(2) SMR CODE				(3)		(4) NATIONAL STOCK NUMBER	(5) DESCRIPTION	(6) USABLE ON CODE	(7) QTY INC IN UNITS	(8) USMC QTY PER EQUIP	
A FIG. NO.	B ITEM NO.	A ARMY	B AIR FORCE	C NAVY	D USMC	A SSI	B REPL FACTOR	REF NUMBER & MFR CODE		U/M			
15	21	PAFZZ	PAOZZ	XBGZZ	PAFZZ	D	.023	5935-00-608-1876	CONNECTOR,ELECTRICAL,REMALE 70-1484 30554	EA	1	1	
15	22	PAFZZ	PAOZZ	XBFZZ	PAFZZ	D	.008	5970-00-914-3117	INSULATION SLEEVING M23053/5-109-0 813649	CLA,CLB CLC	FT	1	V
15	23	PAFZZ	PAOZZ		PAFZZ	D	.008	5970-00-815-1295	INSULATION SLEEVING M323053-5-106-0 81349	CZN,CZM DGG	FT	1	V
15		PAFZZ	PAOZZ		PAFZZ	D	.023	5940-00-283-5280	LUG,TERMINAL M25036-106 96906	C	EA	3	46



VIEW A

Figure 16. Electric Governor System Wiring Harness.

TM9-6115-465-24P
 TO 35C2-3-446-4
 NAVFAC P-8-625-24P
 SL-4-06858B/06859D

(1) ILLUSTRATION A	(2) SMR CODE A	B	C	D	(3)		(4) NATIONAL STOCK NUMBER	(5) DESCRIPTION	USABLE ON CODE	(6) U/M	(7) QTY INC IN UNITS	(8) USMC QTY PER EQUIP
					A	B						
FIG. NO.	ITEM NO.	ARMY	AIR FORCE	NAVY	USMC	SSI	REPL FACTOR	REF NUMBER & MFR CODE				
16		MFFFF			MFFFF			WIRING HARNESS, ELECTRIC GOVERNOR 84-704 30554		EA	1	1
16	1	PAFZZ			PAFZZ		5935-00-725-8233	CONNECTOR PLUG MS3106R20-29S 96906	CLC	EA	1	1
16	2	PAFZZ			PAFZZ			BAND, MARKER BLANK MS43436 1-3 96906	CLC	EA	1	1
16	3	PAFZZ			PAFZZ		5999-01-202-4249	PRINTED WIRING BOARD ASSEMBLY 82-2012 30554	CLC	EA	1	1
16	4	PAFZZ			PAFZZ		5935-00-548-1529	CONNECTOR PLUG MS3106A24-28P 96906	CLC	EA	1	1
16	5	PAFZZ			PAFZZ		5975-01-208-8984	EXTENSION CONNECTOR 81-4917 30554	CLC	EA	1	1
16	6	PAFZZ			PAFZZ		5975-00-451-5001	STRAP, TIEDOWN MS3367-3-9 96906	CLC	EA	1	1
16	7	PAFZZ			PAFZZ		5965-00-598-5416	ADAPTER MS3420-12 96906	CLC	EA	1	1
16	8	PAFZZ			PAFZZ		5365-00-141-6943	ADAPTER MS3420-16 96906	CLC	EA	1	1
16	9	PAFZZ			PAFZZ		6145-00-578-6602	WIRE, ELECTRICAL MS086/2-18-9 96906	CLC	FT	AR	AR
16	10	PAFZZ			PAFZZ		5935-00-721-0488	CONNECTOR PLUG MS3106R14S-6S 96906	CLC	EA	1	1
16	11	PAFZZ			PAFZZ		5935-00-432-8967	CONNECTOR PLUG MS3106R10SL-4S 96906	CLC	EA	1	1
16	12	PAFZZ			PAFZZ		5975-00-570-9598	STRAP, TIEDOWN MS3367-7-9 96906	CLC	EA	AR	AR
16	13	PAFZZ			PAFZZ		6145-00-578-6605	WIRE, ELECTRICAL MS086/2-16-9 96906	CLC	FT	AR	AR
16	14	PAFZZ			PAFZZ		5935-00-823-5322	PLUG END SEAL MS25251-16 96906	CLC	EA	8	8
16	15	PAFZZ			PAFZZ			INSULATION SLEEVING M23053/7-104-C 96906	CLC	FT	AR	AR

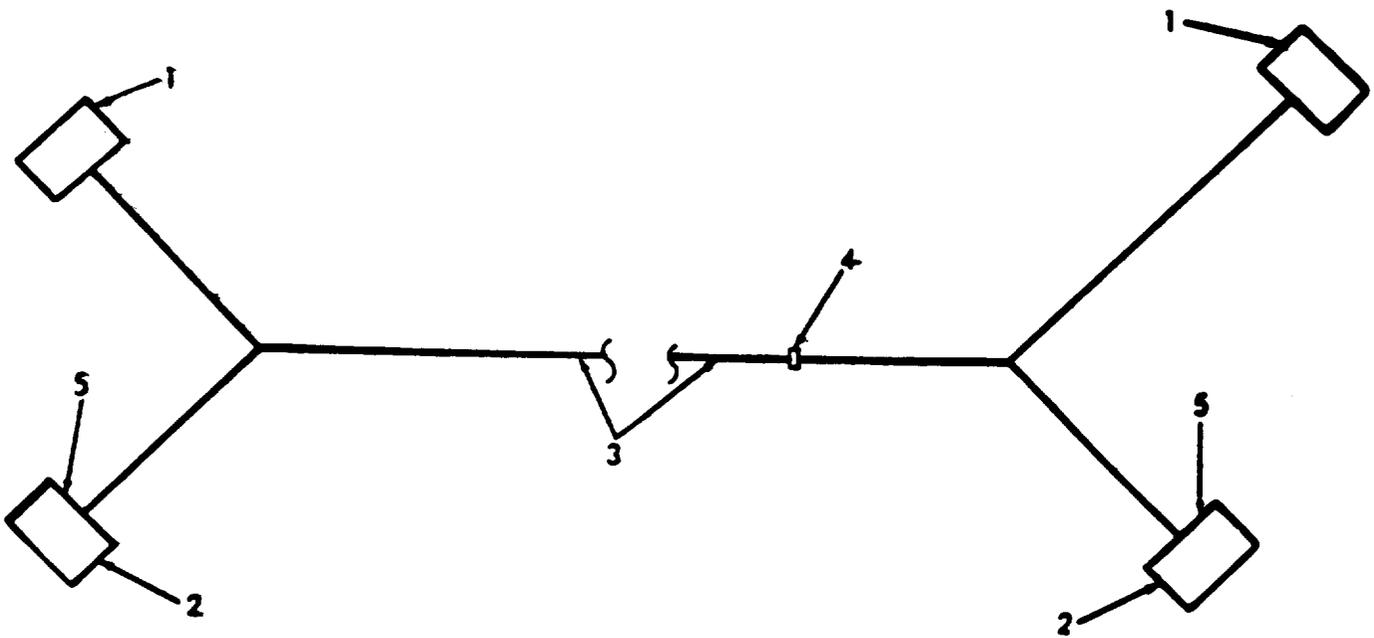

Figure 17. Governor control unit to hydraulic actuator unit wiring harness.

TM9-6115-465-24P
 TO 35C2-3-446-4
 NAVFAC P-8-625-24P
 SL-4-06858B/06859D

(1) ILLUSTRATION A	(2) SMR CODE B	A	B	C	D	(3) A	B	(4) NATIONAL STOCK NUMBER	(5) DESCRIPTION REF NUMBER & MFR CODE	USABLE ON CODE	(6) U/M	(7) QTY INC IN UNITS	(8) USMC QTY PER EQUIP
17		MFOFF	AOO	AGGGG	AFFZZ	-	-		WIRING HARNESS: HYDRAULIC ACTUATOR UNIT TO GOVERNOR CONTROL UNIT 72-2282 30554 30554-72-2282 36024	CLB, CLC DGG	EA	1	
17	1	PAFZZ	PAOZZ	PAGZZ	PAFZZ	D	.023	5935-00-819-5886	CONNECTOR, PLUG MS3106R14S-2P 96906	CLB, CLC CZM, DGG	EA	2	2
17	2	PAFZZ	PAOZZ	PAGZZ	PAFZZ	D	.023	5935-00-820-0555	CONNECTOR, PLUG MS3106R14S-53 96906	CLB, CLC CZM, DGG	EA	2	2
17	3	PAFZZ	PAOZZ	PAGZZ	PAFZZ	D	.080	6145-00-578-6605	WIRE, ELECTRICAL M5086-2-16-9 81349	CLB, CLC CZM, DGG	FT	29	490
17	4	PAFZZ	PAOZZ	PAGZZ	PAFZZ	D	.008	5975-00-111-3208	STRAP, CABLE MS3367-5-9 96906	CLB, CLC CZM, DGG	EA	17	232
17	5	PAFZZ	PAOZZ	PAGZZ	PAFZZ	D	.008	5935-00-823-5322	SEAL, PLUG MS25251-16 96906	CLB, CLC CZN, DGG	EA	2	54

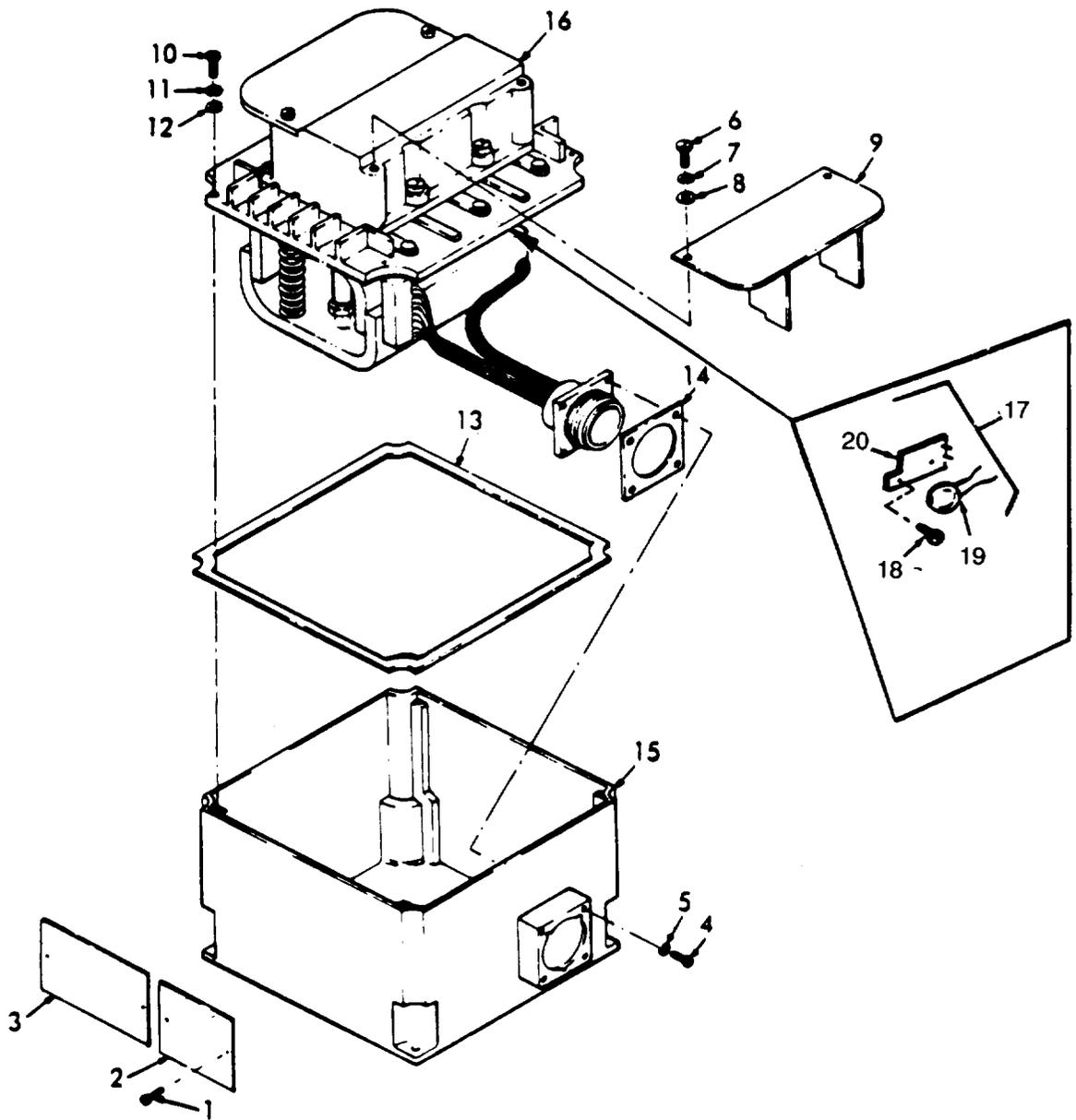

Figure 18. Main load contactor. (sheet 1 of 4)

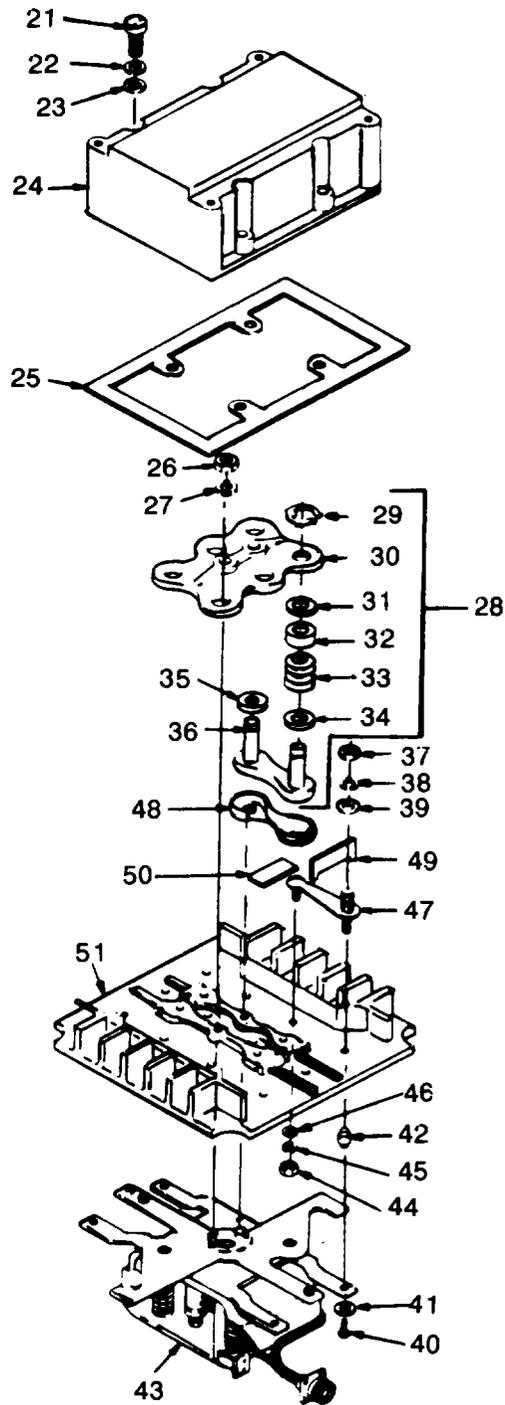

Figure 18. Main load contactor. (sheet 2 of 4)

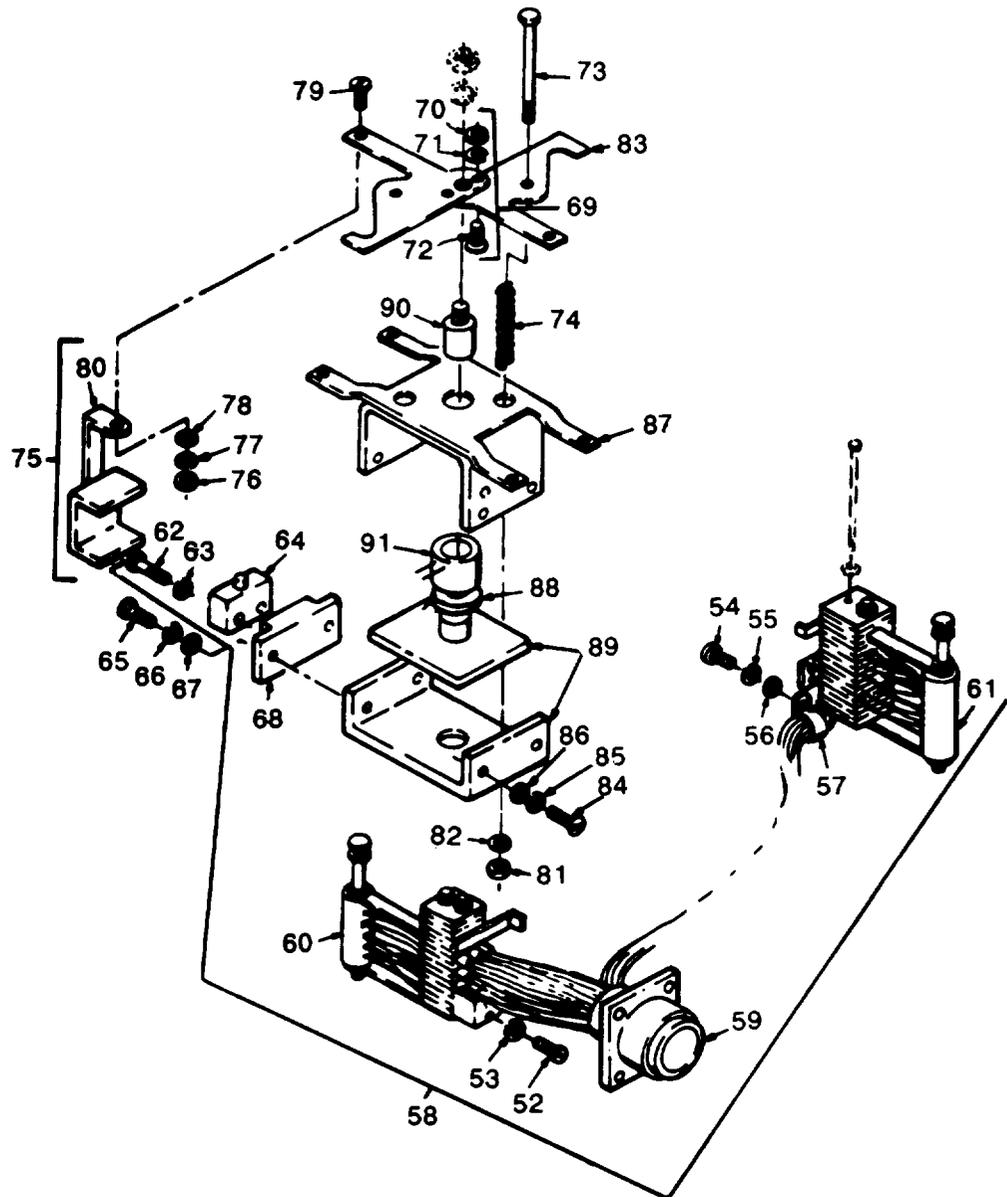

Figure 18. Main load contactor. (sheet 3 of 4)

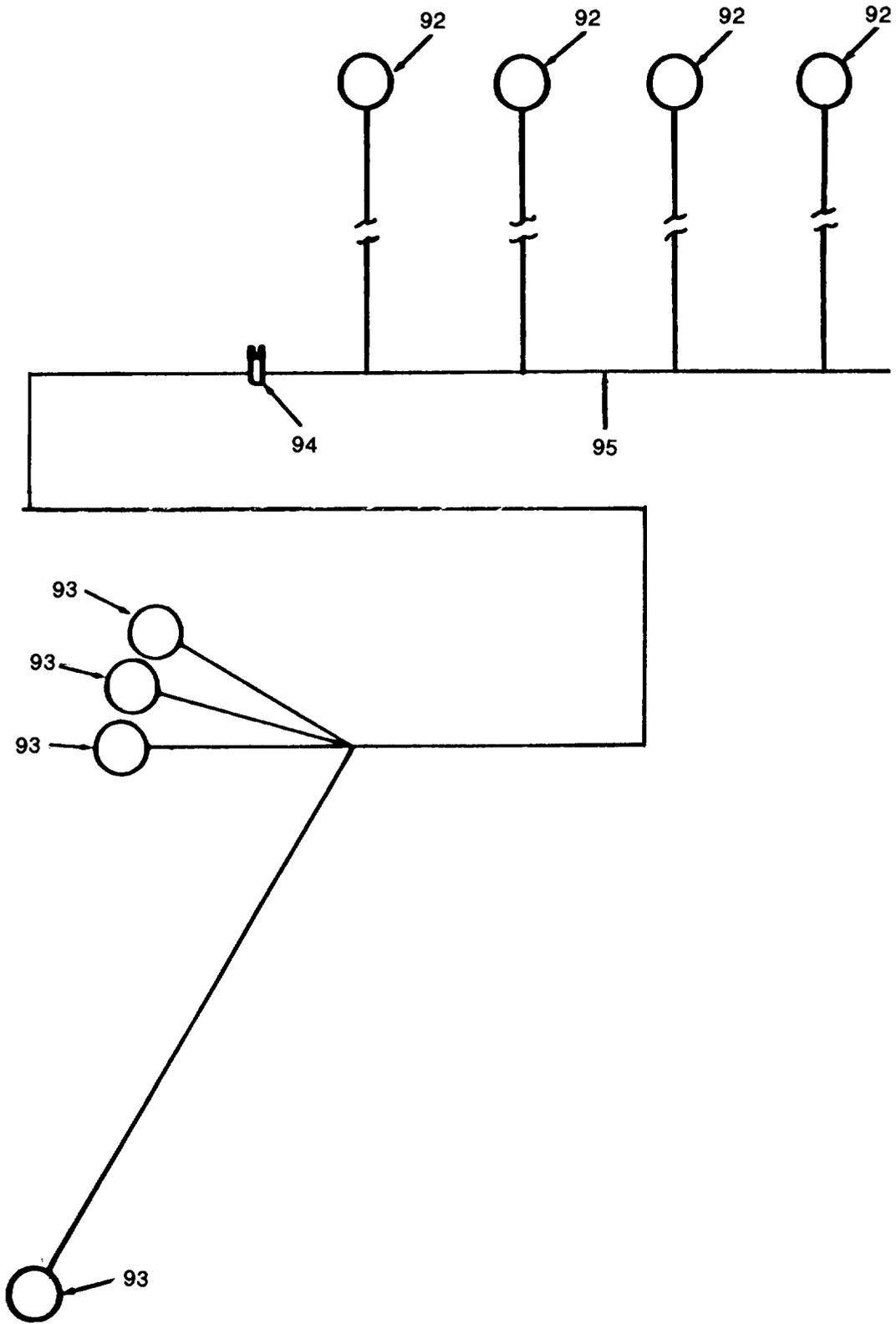

Figure 18. Main load contactor. (sheet 4 of 4) (Landscape)

(1) ILLUSTRATION A FIG. NO.	(2) SMR CODE B ITEM NO.	(3) A ARMY	(3) B AIR FORCE	(3) C NAVY	(3) D USMC	(3) A SSI	(3) B REPL FACTOR	(4) NATIONAL STOCK NUMBER	(5) DESCRIPTION REF NUMBER & MFR CODE	(6) USABLE ON CODE	(6) U/M	(7) QTY INC IN UNITS	(8) USMC QTY PER EQUIP
GROUP 10 - LOAD CONNECTION GROUP													
18	1	XBOZZ	XB	XBOZZ	PAOZZ	-	-	5305-00-253-5615	SCREW,DRIVE:PLATE MTG MS21318-21 96906	EA		4	
18	2	XBFZZ	XB	XBGZZ	MDOZZ	-	-		PLATE IDENTIFICATION 16043-001 74063	EA		1	1
18	3	XBFZZ	XB	XBGZZ	MDOZZ	-	-		PLATE,WIRING DIAGRAM 32225-001 74063	EA		1	1
18	4	PAFZZ	PAOZZ	PAGZZ	PAFZZ	D	.008	5305-00-036-6900	SCREW,MACHINE:CONNECTOR MTG 51208-061 74063	EA		4	4
18	5	PAFZZ	PAOZZ	PAGZZ	PAFZZ	D	.010	5310-00-019-0670	WASHER,LOCK:CONNECTOR MTG MS35333-106 96906	EA		4	4
18	6	PAFZZ	PAOZZ	PAGZZ	PAFZZ	D	.008	5305-00-036-6897	SCREW,MACHINE:TERMINAL COVER MTG 51204-391 74063	EA		4	4
18	7	PAFZZ	PAOZZ	PAGZZ	PAFZZ	D	.010	5310-00-939-1061	WASHER,LOCK:TERMINAL COVER MTG MS35333-104 96906	EA		4	4
18	8	PAFZZ	PAOZZ	PAGZZ	PAFZZ	D	.010	5310-00-228-7563	WASHER,FLAT:TERMINAL COVER MTG 51701-291 74063	EA		4	4
18	9	XBOZZ	XB	XBGZZ	PAFZZ	-	-	5940-00-768-8794	COVER,TERMINAL 28678-001 74063	EA		2	2
18	10	PAFZZ	PAOZZ	PAGZZ	PAFZZ	D	.008	5305-00-036-6901	SCREW,MACHINE:PRIMARY CONTACTOR MTG 51206-401 74063	EA		4	4
18	11	PAFZZ	PAOZZ	PAGZZ	PAFZZ	D	.010	5310-00-045-3299	WASHER,LOCK:PRIMARY CONTACTOR MTG MS35338-42 96906	EA		4	15
18	12	PAFZZ	PAOZZ	XBGZZ	PAFZZ	D	.010	5310-01-033-4893	WASHER,FLAT:PRIMARY CONTACTOR MTG 51702-431 74063	EA		4	16
18	13	PAFZZ	PAOZZ	PAHZZ	PAFZZ	D	.040	5330-00-228-7468	GASKET BASE 30392-001 74063	EA		1	1
18	14	PAFZZ	PAOZZ	PAGZZ	PAFZZ	D	.040	5330-00-036-6996	GASKET RECEPTACLE 15037-006 74063	EA		1	1
18	15	XBFZZ	XB	XBGZZ	PAFZZ	-	-	5945-00-371-9958	CHAMBER,BASE 28676-00 70463	EA		1	1
18	16	PAFZZ	PAOZZ	PAHZZ	PAFZZ	D	.500	5945-01-021-4122	CONTACTOR,PRIMARY 30920-020 74063	EA		1	1
18	17	PAFZZ	PAOZZ	PAFZZ	PAFZZ	-	.005		VARISTOR ASSEMBLY 32223-010 74063	EA		1	1
18	18	PAFZZ	PAOZZ	PAGZZ	PAFZZ	D	.008	5305-00-231-1535	SCREW,MACHINE:VARISTOR MTG NO.4-40X1/4 IN LG 51204-541 74063	EA		2	9
18	19	XAFZZ	XA	XAFZZ	XAFZZ				VARISTOR 57400-016 74063	EA		1	
18	20	XAFZZ	XA	XAFZZ	XAFZZ				PLATE,COMPONENT MOUNTING 32187-001 74063	EA		1	
18		XAFZZ	XA	XAFZZ	XAFZZ				WIRE, NO.22 TEFLON,BLACK 53601-036 74063	FT		1	
18		XAFZZ	XA	XAFZZ	XAFZZ				WIRE, NO.22 TEFLON,RED 53601-043 74063	FT		1	

(1) ILLUSTRATION		(2) SMR CODE				(3)		(4) NATIONAL STOCK NUMBER	(5) DESCRIPTION	(6) USABLE ON CODE	(7) QTY INC IN UNITS	(8) USMC QTY PER EQUIP
A FIG. NO.	B ITEM NO.	A ARMY	B AIR FORCE	C NAVY	D USMC	A SSI	B REPL FACTOR	REF NUMBER & MFR CODE	U/M			
18	21	PAFZZ	PAOZZ	PAGZZ	PAFZZ	D	.008	5305-00-231-1572 SCREW,MACHINE:CHAMBER MTG 51204-831 74063	EA	4	4	
18	22	PAFZZ	PAOZZ	PAGZZ	PAFZZ	D	.010	5310-00-720-8395 WASHER,LOCK:CHAMBER MTG MS35338-104 96906	EA	4	4	
18	23	PAFZZ	PAOZZ	XBFZZ	PAFZZ	D	.010	5310-00-505-2385 WASHER,FLAT,CHAMBER MTG 51702-121- 74063	EA	4	5	
18	24	XBFZZ	XB	XBGZZ	XBFZZ	-	-	COVER,ASSEMBLY:CONTACTOR 30413-010 74063	EA	1	1	
18	25	PAFZZ	PAOZZ	PAGZZ	PAFZZ	-	.040	5330-00-036-6998 GASKET:CHAMBER 28744-001 74063	EA	1	1	
18	26	PAFZZ	PAOZZ	XBGZZ	PAFZZ	D	.008	5310-00-397-4707 NUT,PLAIN,HEXAGON:OPERATOR MTG 50410-031 74063	EA	2	4	
18	27	PAFZZ	PAOZZ	PAGZZ	PAFZZ	D	.010	5310-00-019-0672 WASHER,LOCK-OPERATOR MTG 51810-011 74063 MS35333-107 96906	EA	2	4	
18	28	PAFZZ	PAOZZ	PAHZZ	PAFZZ	-	.050	5999-00-031-3941 OPERATOR,MAIN 30592-010 74063	EA	1	1	
18	29	XAFZZ	PAOZZ	XAHZZ	XAFZZ	-	-	RING,RETAINING 50900-111 74063	EA	6	6	
18	30	XAFZZ	XA	XAHZZ	PAFZZ	-	-	CONTACT,MAIN 28316-001 74063	EA	1	1	
18	31	XAFZZ	XA	XAHZZ	PAFZZ	-	-	SHIM,BRIDGE 10127-003 74063	EA	V	V	
18	32	XAFZZ	XA	XAHZZ	XAFZZ	-	-	BUSHING,LOCATING 30825-001 74063	EA	6	6	
18	33	XAFZZ	PAOFF	XAHZZ	XAFZZ	-	-	SPRING,BRIDGE 28419-002 74063	EA	6	6	
18	34	XAFZZ	PAOZZ	XAHZZ	XAFZZ	-	-	5365-00-140-9308 SHIM,BRIDGE 10127-001 74063	EA	V	V	
18	35	XAFZZ	PAOZZ	XAHZZ	XAFZZ	-	-	5365-00-137-5116 SHIM,BRIDGE 10727-002 74063	EA	V	V	
18	36	XAFZZ	XA	XAHZZ	XAFZZ	-	-	BRIDGE 30590-010 74063	EA	3	3	
18	37	XAFZZ	PAOZZ	PAGZZ	PAFZZ	D	.008	5310-00-199-1056 NUT,PLAIN,HEXAGON:CONTACT MS35650-3385 96906	EA	6	6	
18	38	PAFZZ	PAOZZ	PAGZZ	PAFZZ	D	.010	5310-00-184-8971 WASHER,LOCK:CONTACT MS35338-103 96906	EA	6	6	
18	39	PAFZZ	PAOZZ	XBGZZ	PAFZZ	D	.008	5310-00-038-2739 WASHER,FLAT CONTACT 9305-001 74063	EA	6	6	
18	40	PAFZZ	PAOZZ	XBGZZ	PAFZZ	D	.008	5305-00-397-4708 SCREW,MACHINE:ADJUSTABLE BUSHING 51208-211 74063	EA	4	4	
18	41	PAFZZ	PAOZZ	PAGZZ	PAFZZ	D	.010	5310-00-038-2738 WASHER,LOCK ADJUSTABLE BUSHING 51808-021 74063	EA	4	18	
18	42	XBFZZ	XA	XBFZZ	XBFZZ	-	-	BUSHING TO BASE, ADJUSTABLE:CORE AND FRAME 32003-010 74063	EA	2	2	

(1) ILLUSTRATION		(2) SMR CODE				(3)		(4)	(5)	(6)	(7)	(8)
A	B	A	B	C	D	A	B	NATIONAL STOCK NUMBER	DESCRIPTION	USABLE ON CODE	QTY INC IN UNITS	USMC QTY PER EQUIP
FIG. NO.	ITEM NO.	ARMY	AIR FORCE	NAVY	USMC	SSI	REPL FACTOR		REF NUMBER & MFR CODE	U/M		
18	43	XBFZZ	XA	XBHZZ	XBFZZ	-	-		BASE ASSEMBLY 30469-020 74063	EA	1	1
18	44	PAFZZ	PAOZZ	XBFZZ	PAFZZ	-	-	5310-00-397-4711	NUT, PLAIN, HEXAGON: CONTACT 50408-081 74063	EA	12	14
18	45	PAFZZ	PAOZZ	PAGZZ	PAFZZ	D	.010	5310-00-038-2738	WASHER, LOCK: CONTACT 51808-021 74063	EA	12	16
18	46	PAFZZ	PAOZZ	XBGZZ	PAFZZ	D	.010	5310-00-221-3153	WASHER, FLAT: CONTACT 1290497 80064	EA	12	16
18	47	PAFZZ	PAOZZ	PAHZZ	PAFZZ	-	.050	5999-00-255-9313	CONTACT 30651-010 74063	EA	6	6
18	48	XBFZZ	XB	XBHZZ	PAFZZ	-	-	5970-00-030-7629	ARC CHUTE 28623-001 74063	EA	3	3
18	49	XBFZZ	PAOZZ	PAHZZ	PAFZZ	-	-	5325-00-926-0665	GROMMET: CONTACT 28791-001 74063	EA	6	6
18	50	XBFZZ	XA	XBHZZ	XBFZZ	-	-		SPACER: CONTACT 30720-001 74063	EA	3	3
18	51	XBFZZ	PAOZZ	XAHZZ	PAFZZ	-	-	5945-00-394-6857	BASE, MAIN 29233-001 74063	EA	1	1
18	52	PAFZZ	PAOZZ	PAGZZ	PAFZZ	D	.008	5305-00-231-1536	SCREW, LENS: CONTACT 51204-541 74063	EA	7	9
18	53	PAFZZ	PAOZZ	PAGZZ	PAFZZ	D	.010	5310-00-228-7591	WASHER, LOCK: CLAMP MTG 51804-021 74063	EA	1	8
18	54	PAFZZ	PAOZZ	PAGZZ	PAFZZ	D	.008	5305-00-228-7508	SCREW, MACHINE: CLAMP MTG 51204-781 74063	EA	1	1
18	55	PAFZZ	PAOZZ	PAGZZ	PAFZZ	D	.010	5310-00-228-7591	WASHER, LOCK: CLAMP MTG 51804-021 74063	EA	5	8
18	56	PAFZZ	PAOZZ	XBFZZ	PAFZZ	D	.010	5310-00-505-2385	WASHER, FLAT: CLAMP MTG 51702-121 74063	EA	1	5
18	57	PAFZZ	PAOZZ	XBFZZ	PAFZZ	D	.023	5340-00-809-8805	CLAMP, WIRE 52001-006 74063	EA	1	1
18	58	PAFZZ	PAOZZ	PAGZZ	AFFZZ	-	-	5935-00-024-1038	CONNECTOR, AUXILIARY 29900-010 74063	EA	1	1
18	59	PAFZZ	PAOZZ	PAGZZ	PAFZZ	-	0.30	5935-00-024-1060	CONNECTOR, WIRE 29901-010 74063	EA	1	1
18	60	PAFZZ	PAOZZ	PAGZZ	PAFZZ	-	.050	5999-00-003-4578	CONTACT, AUXILIARY 28996-010 74063	EA	1	1
18	61	PAFZZ	PAOZZ	PAGZZ	PAFZZ	-	.050	5999-00-003-4579	CONTACT, AUXILIARY 29014-010 74063	EA	1	1
18	62	PAFZZ	PAOZZ	PAGZZ	PAFZZ	D	.008	5305-00-500-3542	SCREW, MACHINE: SWITCH MTG 14895-001 74063	EA	2	2
18	63	PAFZZ	PAOZZ	PAGZZ	PAFZZ	D	.010	5310-00-228-7679	WASHER, LOCK: SWITCH MTG 51802-011 74063	EA	2	2
18	64	PAFZZ	PAOZZ	PAGZZ	PAFZZ	-	.050	5930-00-993-4654	SWITCH 50301-049 74063	EA	1	1
18	65	PAFZZ	PAOZZ	PAGZZ	PAFZZ	D	.008	5305-00-231-1617	SCREW, MACHINE: ACTUATOR MTG 51204-231 74063	EA	2	2

(1) ILLUSTRATION		(2) SMR CODE				(3)		(4)	(5)	(6)	(7)	(8)
A	B	A	B	C	D	A	B	NATIONAL STOCK NUMBER	DESCRIPTION	USABLE ON CODE	QTY INC IN UNITS	USMC QTY PER EQUIP
FIG. NO.	ITEM NO.	ARMY	AIR FORCE	NAVY	USMC	SSI	REPL FACTOR		REF NUMBER & MFR CODE	U/M		
18	66	PAFZZ	PAOZZ	PAGZZ	PAFZZ	D	.010	5310-00-263-8416	WASHER, LOCK:ACTUATOR MTG 51804-011 74063	EA	2	2
18	67	PAFZZ	PAOZZ	PAGZZ	PAFZZ	D	.010	5310-00-228-7678	WASHERS, FLAT:ACTUATOR MTG 51701-301 74063	EA	2	2
18	68	XBFZZ	XA	XBGZZ	XBFZZ	-	-		BRACKET:SWITCH 27873-001 74063	EA	1	1
18	69	XBFZZ	XA	XBHZZ	PPFZZ	-	-		ACTUATOR ASSEMBLY 30921-010 74063	EA	1	1
18	70	PAFZZ	PAOZZ	XBGZZ	PAFZZ	D	.008	5310-00-397-4707	NUT, PLAIN, HEXAGON:ACTUATOR MTG 50410-031 74063	EA	2	4
18	71	PAFZZ	PAOZZ	PAGZZ	PAFZZ	D	.010	5310-00-228-7599	WASHER, LOCK:ACTUATOR MTG 51810-011 74063	EA	2	4
18	72	PAFZZ	PAOZZ	XBGZZ	PAFZZ	D	.050	5940-00-683-4339	TERMINAL:ACTUATOR 51410-002 74063	EA	1	1
18	73	XBGZZ	XB	XBGZZ	XBFZZ	-	-		ROD, GUIDE 31827-001 74063	EA	2	2
18	74	XBFZZ	PAOZZ	PAGZZ	PAFZZ	-	.015	5360-00-231-1501	SPRING, RETURN 30707-001 74063	EA	2	2
18	75	PAFZZ	PAOZZ	PAHZZ	PAFZZ	-	.050	5945-00-371-9858	OPERATOR ASSEMBLY 30596-020 74063	EA	1	1
18	76	PAFZZ	PAOZZ	XAHZZ	PAFZZ	-	-	5310-00-928-2683	NUT, PLAIN, HEXAGON:BRACKET MTG 50406-031 74063	EA	1	1
18	77	PAFZZ	PAOZZ	XAGZZ	PAFZZ	-	-	5310-00-397-5404	WASHER, LOCK:BRACKET MTG 51806-031 74063	EA	1	1
18	78	PAFZZ	PAOZZ	XAGZZ	PAFZZ	-	-	5310-00-432-3550	WASHER, FLAT:BRACKET MTG 51702-151 74063	EA	1	1
18	79	PAFZZ	PAOZZ	XAGZZ	PAFZZ	-	-	5305-00-397-4710	SCREW, MACHINE:BRACKET MTG 51026-251 74063	EA	1	1
18	80	XBFZZ	XA	XAHZZ	XAFZZ	-	-		BRACKET 31877-010 74063	EA	1	1
18	81	PAFZZ	PAOZZ	XBGZZ	PAFZZ	-	-	5310-00-397-4711	NUT, PLAIN, HEXAGON:GUIDE ROD 50408-081 74063	EA	2	14
18	82	PAFZZ	PAOZZ	XBGZZ	PAFZZ	D	.010	5310-00-397-5424	WASHER, LOCK:GUIDE ROD 51808-011 74063	EA	2	2
18	83	XBFZZ	XB	XBHZZ	XBFZZ	-	-		OPERATOR, AUXILIARY 30274-002 74063	EA	1	1
18	84	PAFZZ	PAOZZ	XBGZZ	PAFZZ	D	.008	5305-00-397-4712	SCREW, MACHINE:END PLATE 51210-271 74063	EA	4	4
18	85	PAFZZ	PAOZZ	XBGZZ	PAFZZ	D	.010	5310-00-045-3296	WASHER, LOCK:END PLATE MTG 51810-031 74063	EA	4	8
18	86	PAFZZ	PAOZZ	XBFZZ	PAFZZ	D	.010	5310-00-264-0694	WASHER, FLAT:END PLATE MTG LN5635 35510	EA	4	7
18	87	XBFZZ	PAOZZ	XBGZZ	PAFZZ	-	-	5945-00-394-6865	PLATE, END 30918-010 74063	EA	1	1
18	88	XBFZZ	XA	XBGZZ	XBFZZ	-	-		WASHER, COIL 27289-001 74063	EA	1	1

TM9-6115-465-24P
 TO 35C2-3-446-4
 NAVFAC P-8-625-24P
 SL-4-06858B/06859D

(1) ILLUSTRATION		(2) SMR CODE				(3)		(4) NATIONAL STOCK NUMBER	(5) DESCRIPTION	(6) USABLE ON CODE	(7) QTY INC IN UNITS	(8) USMC QTY PER EQUIP
A FIG. NO.	B ITEM NO.	A ARMY	B AIR FORCE	C NAVY	D USMC	A SSI	B REPL FACTOR	REF NUMBER & MFR CODE	U/M			
18	89	XBFZZ	XA	XBHZZ	XBFZZ	-	-	CORE AND FRAME 30789-010 74063	EA	1	1	
18	90	XBFZZ	XA	XBHZZ	XBFZZ	-	-	CORE AND ROD 30595-010 74063	EA	1	1	
18	91	PAFZZ	PAOZZ	PAGZZ	PAFZZ	-	.050	5950-00-024-1052 COIL 303096-010 74063	EA	1	1	
18		MFFFF	AOO	PBGGG	APFZZ	-	-	6115-01-024-5955 WIRING HARNESS: CONTACTOR TO LOAD TERMINAL 72-2290-2 30554 30554-72-2290-2 36024 MANUFACTURE FROM:	EA	1	1	
18	92	PAFZZ	PAOZZ	XBHZZ	PAFZZ	D	.050	5940-00-115-4996 LUG, TERMINAL MS20659-145 96906	EA	4	4	
18	93	PAFZZ	PAOZZ	PAGZZ	PAFZZ	D	.050	5940-00-557-4338 LUG, TERMINAL MS25036-125 96906	EA	4	10	
18	94	PAFZZ	PAOZZ	PAGZZ	PAFZZ	D	.008	5975-00-111-3208 STRAP, CABLE 96906 MS3367-5-9	EA	8	232	
18	95	PAFZZ	PAOZZ	XBGZZ	PAFZZ	D	.080	6145-00-578-6595 WIRE, ELECTRICAL M5088/2-4-9 81349	FT	12	13	

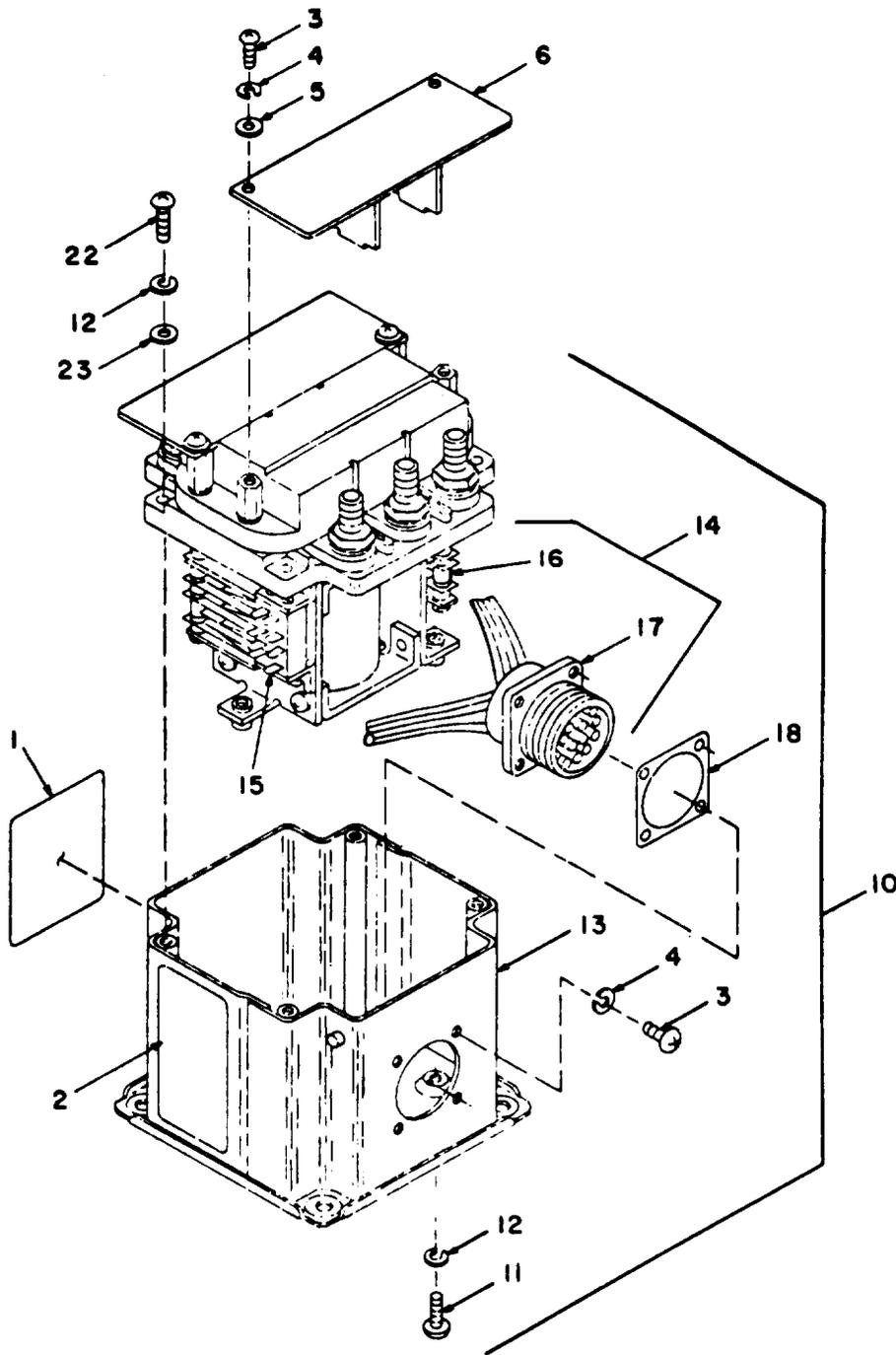

Figure 19. Main load contactor HB200A. (sheet 1 of 3)

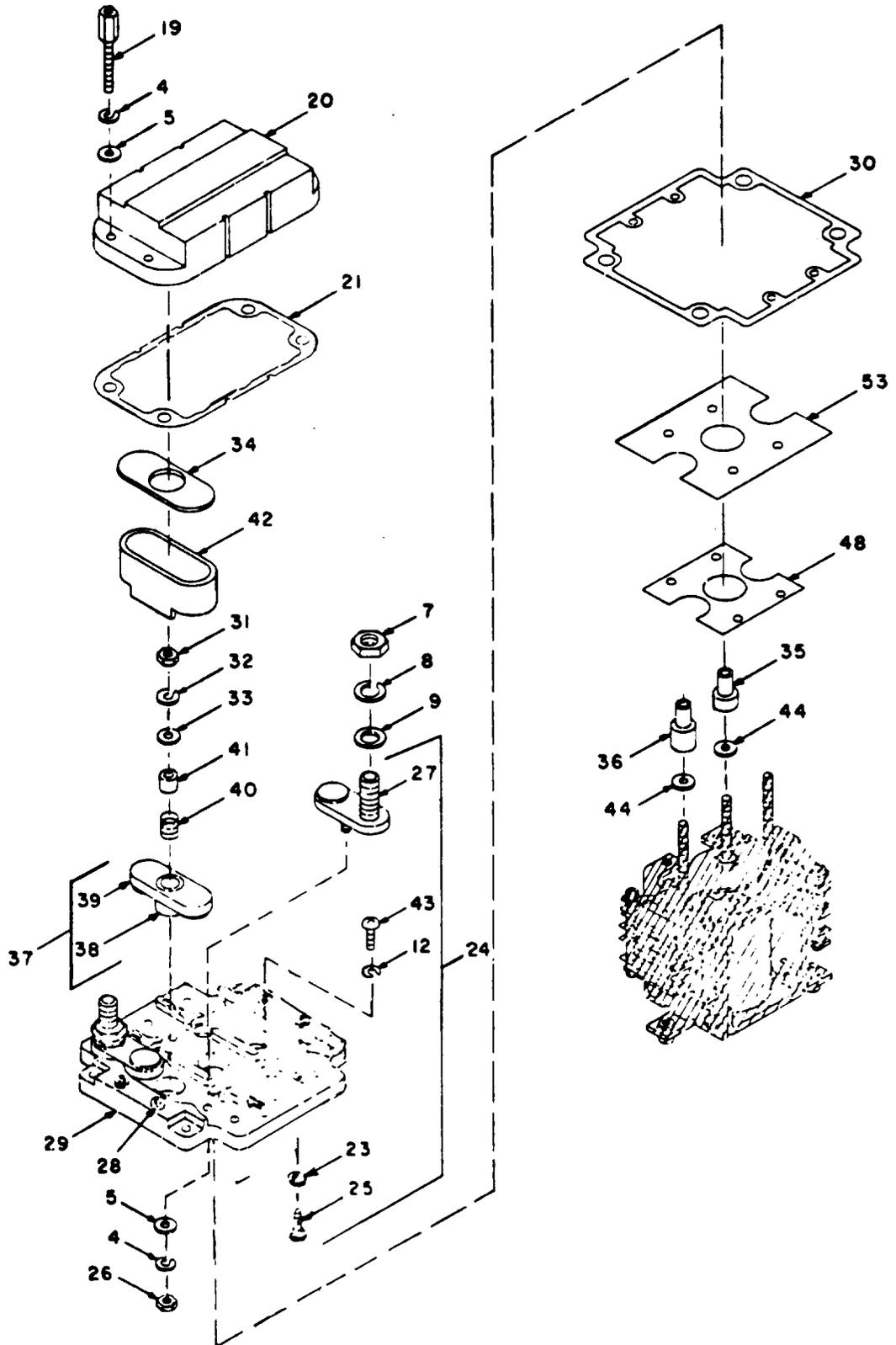

Figure 19. Main load contactor HB200A. (sheet 2 of 3)

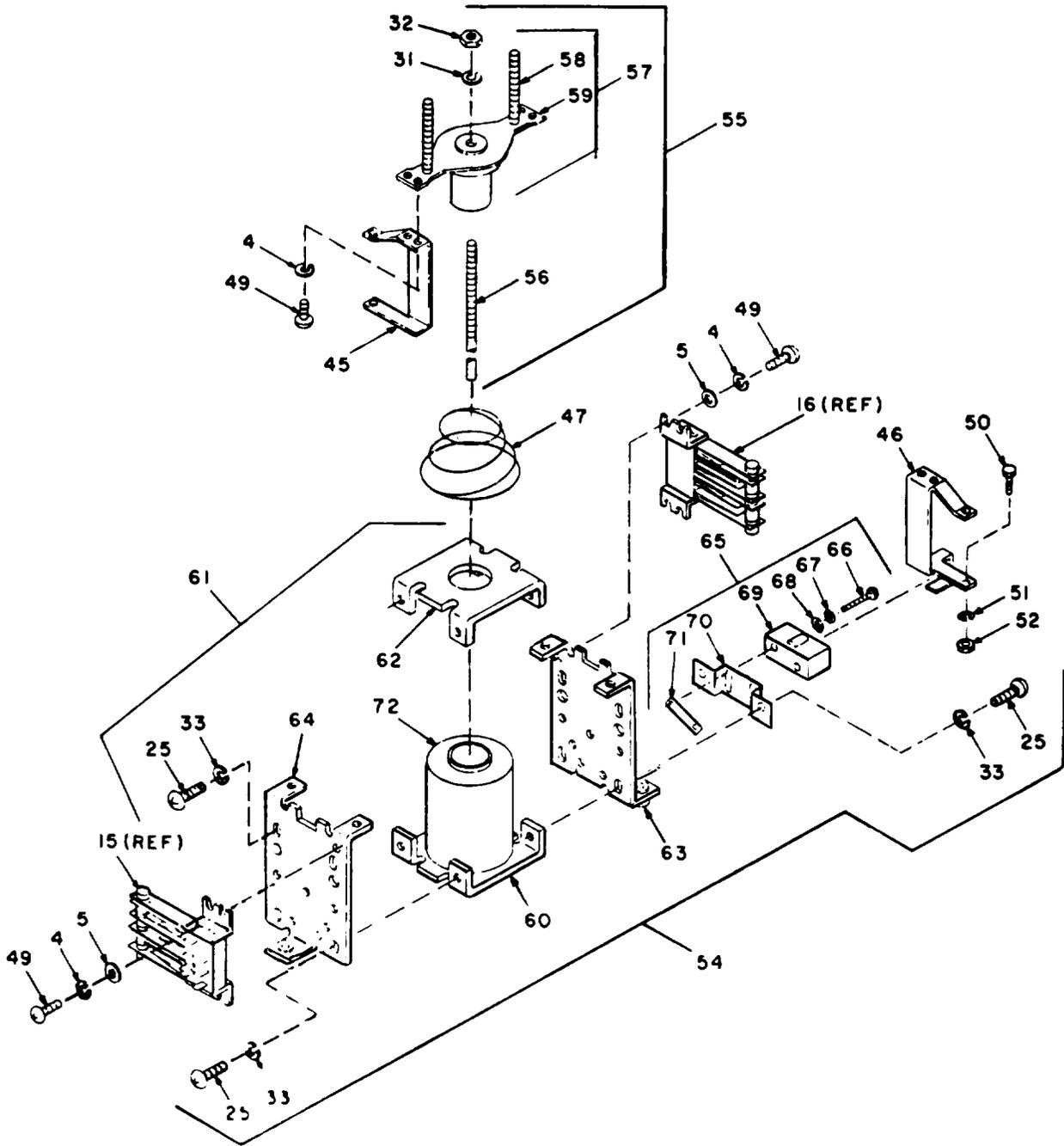

Figure 19. Main load contactor HB200A. (sheet 3 of 3)

(1) ILLUSTRATION A FIG. NO.	(2) SMR CODE B ITEM NO.	A	B	C	D	(3)		(4) NATIONAL STOCK NUMBER	(5) DESCRIPTION REF NUMBER & MFR CODE	(6) USABLE ON CODE U/M	(7) QTY INC IN UNITS	(8) USMC QTY PER EQUIP
						A	B					
19		PAOFF	PAOZZ									
19	1	XCFZZ	XC					5945-01-021-2898	LOAD CONTACTOR MAIN 70-501-2 30554 HR200A 50603	EA	1	1
19	2	XCFZZ	XC						PLATE,IDENT 10818-1 50603	EA	1	1
19	3	PAOZZ	PAOZZ					5305-00-984-4988	PLATE,WIRING DIAGRAM 103801 50603	EA	1	1
19	4	PAOZZ	PAOZZ					5305-00-984-4988	SCREW,MACHINE 6-32X3/8 MS35206-228 96906	EA	8	14
19	5	PAOZZ	PAOZZ					5310-00-045-4007	WASHER,LOCK NO.6 MS35338-41 96906	EA	26	68
19	6	PAOZZ	PAOZZ					5310-00-082-1404	WASHER,FLAT 3/8X.156X.049 MS27183-6 96906	EA	14	37
19	7	XBOZZ	PAOZZ						SHIELD,TERMINAL 10485-1 50603	EA	2	2
19	8	PAFZZ	PAOZZ					5310-01-008-6409	NUT,HEX 3/8-24X5/8X7/32 4971110017 50603	EA	6	6
19	9	PAFZZ	PAOZZ					5310-00-184-8971	WASHER,LOCK 11/16X3/8X0.094 MS35333-103 96906	EA	6	12
19	10	PAFZZ	PAOZZ					5310-00-080-6004	WASHER,FLAT 13/6X3/8X0.062 MS27183-14 96906	EA	6	6
19	11	XAFZZ	XA						CONTRACTOR ASSY.SUB 10813-10 50603	EA	1	1
19	12	PAFZZ	PAOZZ					5305-00-889-3002	SCREW,MACHINE 8/32 X 5/16 MS35206-242 96906	EA	11	11
19	13	PAFZZ	PAOZZ					5310-00-045-3299	WASHER,LOCK NO.8 MS35338-42 96906	EA	12	38
19	14	XBFZZ	PAOZZ						COVER 10741-10 50603	EA	1	1
19	15	PAFZZ	PAOZZ					5945-01-013-3842	SWITCH,CONN.ASSY 10819-10 50603	EA	1	1
19	16	PAFZZ	PAOZZ					5945-01-016-0797	SWITCH,AUX 10788-10 50603	EA	1	1
19	17	PAFZZ	PAOZZ					5945-01-016-0798	SWITCH,AUX 10789-10 50603	EA	1	1
19	18	PAFZZ	PAOZZ					5935-01-015-2098	CONNECTOR 10819-20 68505	EA	1	1
19	19	PAFZZ	PAOZZ					5330-01-008-6584	GASKET 3126760001 50603	EA	1	1
19	20	PAFZZ	PAOZZ					5365-01-008-6420	SPACER LOCKING 10717-1 50603	EA	4	4
19	21	XBFZZ	XA						CHAMBER CONTACT 10484-1 50603	EA	1	1
19	22	PAFZZ	PAOZZ					5330-01-014-6875	GASKET,HSG 10501-1 50603	EA	1	1
19	23	PAFZZ	PAOZZ					5305-00-984-6194	SCREW,MACHINE 8-32 X 5/8 MS35206-246 96906	EA	4	6

(1) ILLUSTRATION		(2) SMR CODE			(3)			(4)	(5)	(6)	(7)	(8)
A	B	A	B	C	D	A	B	NATIONAL STOCK NUMBER	DESCRIPTION	USABLE ON CODE	QTY INC IN UNITS	USMC QTY PER EQUIP
FIG. NO.	ITEM NO.	ARMY	AIR FORCE	NAVY	USMC	SSI	REPL FACTOR	REF NUMBER & MFR CODE		U/M		
19	23	PAFZZ	PAOZZ		PAFZZ	D	.010	5310-00-809-8544	WASHER, FLAT 3/8 X.187X.047 MS27183-7 96906	EA	14	30
19	24	PAFZZ	PAOZZ		PAFZZ	D	.008	6115-01-010-5912	BASE ASSY 10802-10 50603	EA	1	1
19	25	PAFZZ	PAOZZ		PAFZZ	D	.008	5305-01-008-6421	SCREW, MACHINE 10-32 X 1/2 4181100041 50603	EA	14	14
19	26	PAFZZ	PAOZZ		PAFZZ	D	.008	5310-01-008-6410	NUT, HEX 4911100011 50603	EA	6	6
19	27	PAFZZ	PAOZZ		PAFZZ	D	.001	6150-01-010-2597	BUS BAR ASSY 10497-10 50603	EA	6	6
19	28	XBFZZ	XB		XBFZZ				INSERT 10064-1 50603	EA	4	4
19	29	XAFZZ	XA		XAFZZ				BASE MAIN 10502-1 50603	EA	1	1
19	30	PAFZZ	PAOZZ		PAFZZ	-	.030	5330-01-008-6565	GASKET, MAIN BASE 10505-1 50603	EA	1	1
19	31	PAFZZ	PAOZZ		PAFZZ	D	.008	5310-00-281-9389	NUT, HEX 10-32 X 3/8 X1/8 493100041 50603	EA	3	3
19	32	PAFZZ	PAOZZ		PAFZZ	D	.010	5310-00-045-3296	WASHER, LOCK NO.10 MS35338-43 96906	EA	4	13
19	33	PAFZZ	PAOZZ		PAFZZ	D	.010	5310-00-008-6596	WASHER, FLAT 3/8 X .203 X .047 5611100031 50603	EA	9	9
19	34	PAFZZ	PAOZZ		PAFZZ	D	.008	5365-01-008-6422	SPACER 10812-1 50603	EA	3	3
19	35	PAFZZ	PAOZZ		PAFZZ	D	.006	3120-01-008-6591	BUSHING 10692-1 50603	EA	1	1
19	36	PAFZZ	PAOZZ		PAFZZ	D	.006	3120-01-008-6592	BUSHING 10692-2 50603	EA	2	1
19	37	PAFZZ	PAOZZ		PAFZZ	-	.007	5945-01-010-5913	BRIDGE ASSY, MOVABLE 10715-10 50603	EA	3	3
19	38	XAFZZ	XA		XAFZZ				HOUSING, SPRING 10483-1 50603	EA	3	3
19	39	XAFZZ	XA		XAFZZ				BRIDGE, MAIN CONTACTOR 10493-1 50603	EA	3	3
19	40	PAFZZ	PAOZZ		PAFZZ	-	.015	5360-01-014-6934	SPRING, MAIN CONTACTOR 10703-1 50603	EA	3	3
19	41	PAFZZ	PAOZZ		PAFZZ	D	.006	3120-01-008-6593	BUSHING 10048-1 50603	EA	3	3
19	42	XBFZZ	XB		XBFZZ				ARC CHUTE 10481-1 50603	EA	3	3
19	43	PAFZZ	PAOZZ		PAFZZ	D	.008	5305-00-984-6193	SCREW, MACHINE 8-32 X 1/2 MS35206-245 96906	EA	4	4
19	44	PAFZZ	PAOZZ		PAFZZ	D	.010	5310-01-008-6424	WASHER, METALLIC 10209-1 50603	EA	V	V
19	45	PAFZZ	PAOZZ		PAFZZ	D	.020	5945-01-010-5914	OPERATOR, AUX SWITCH 10422-1 50603	EA	1	1

(1) ILLUSTRATION		(2) SMR CODE		(3)			(4) NATIONAL STOCK NUMBER		(5) DESCRIPTION	(6) USABLE ON CODE	(7) QTY INC IN UNITS	(8) USMC QTY PER EQUIP
A FIG. NO.	B ITEM NO.	A ARMY	B AIR FORCE	C NAVY	D USMC	A SSI	B REPL FACTOR	REF NUMBER & MFR CODE	U/M			
19	46	PAFZZ	PAFZZ		PAFZZ	-	.020	5115-01-010-5915 OPERATOR,AUX SWITCH 10422-2 50603	EA	1	1	
19	47	PAFZZ	PAFZZ		PAFZZ	-	.030	5360-01-008-6425 SPRING,RETURN 10122-1 50603	EA	1	1	
19	48	XBFZZ	XB		XBFZZ			DETENT 10078-2 50603	EA	1	1	
19	49	PAFZZ	PAFZZ		PAFZZ	D	.008	5305-01-008-6426 SCREW,MACHINE 6-32X3/16 4161100011 50603	EA	8	8	
19	50	PAFZZ	PAFZZ		PAFZZ	D	.008	5305-00-984-4982 SCREW,MACHINE 4-40 X 3/8 MS35206-225 96906	EA	4	12	
19	51	PAFZZ	PAFZZ		PAFZZ	D	.010	5310-00-543-2410 WASHER,LOCK NO.4 MS35338-40 96906	EA	4	16	
19	52	PAFZZ	PAFZZ		PAFZZ	D	.008	5310-01-008-6411 NUT,HEX,NO.4-40 X 1/4 X 3/32 4891110011 50603	EA	4	4	
19	53	PAFZZ	PAFZZ		PAFZZ	D	.020	5970-01-010-5848 INSULATION 10718-1 50603	EA	1	1	
19	54	PAFZZ	PAFZZ		PAFZZ	-	.020	5945-01-010-5916 SOLOINOID ASSY 10798-10 50603	EA	1	1	
19	55	PAFZZ	PAFZZ		PAFZZ	-	.020	6115-01-010-5920 MOVABLE CORE ROD ASSY 10795-10 50603	EA	1	1	
19	56	XAFZZ	XA		XAFZZ			ROD,CORE 10008-22 50603	EA	1	1	
19	57	XAFZZ	XA		XAFZZ			CORE ASSY,MOVABLE 10794-10 50603	EA	1	1	
19	58	XAFZZ	XA		XAFZZ			STUD,SELF LOCKING 4431100031 50603	EA	2	2	
19	59	XAFZZ	XA		XAFZZ			OPERATOR 10421-1 50603	EA	1	1	
19	60	PAFZZ	PAFZZ		PAFZZ		.020	5945-01-010-5917 FRAME AND CORE ASSY 10793-10 50603	EA	1	1	
19	61	XAFZZ	XA		XAFZZ			FRAME ASSY,SIDE 10790-10 50603	EA	1	1	
19	62	XAFZZ	XA		XAFZZ			FRAME END 10007-2 50603	EA	1	1	
19	63	XAFZZ	XA		XAFZZ			FRAME AND SPACER 10792-10 50603	EA	1	1	
19	64	XAFZZ	XA		XAFZZ			FRAME AND SPACER 10791-10 50603	EA	1	1	
19	65	PAFZZ	PAFZZ		PAFZZ		.010	5930-01-019-1280 MICRO SWITCH AND BRACKET ASSY 10797-10 50603	EA	1	1	
19	66	PAFZZ	PAFZZ		PAFZZ	D	.008	5305-01-008-6428 SCREW,MACHINE 2-56 X 3/4 4121100021 50603	EA	2	2	
19	67	PAFZZ	PAFZZ		PAFZZ	D	.010	5310-00-543-5060 WASHER,LOCK NO.2 MS35338-39 96906	EA	2	2	
19	68	PAFZZ	PAFZZ		PAFZZ	D	.010	5310-01-008-6597 WASHER,FLAT .250 X .105 X .032 5601100011 50603	EA	2	2	

TM9-6115-465-24P
 TO 35C2-3-446-4
 NAVFAC P-8-625-24P
 SL-4-06858B/06859D

(1) ILLUSTRATION		(2) SMR CODE				(3)		(4) NATIONAL STOCK NUMBER	(5) DESCRIPTION	(6) USABLE ON CODE	(7) QTY INC IN UNITS	(8) USMC QTY PER EQUIP
A FIG. NO.	B ITEM NO.	A ARMY	B AIR FORCE	C NAVY	D USMC	A SSI	B REPL FACTOR	REF NUMBER & MFR CODE	U/M			
19	69	PAFZZ	PAOZZ		PAFZZ	-	.060	5930-00-914-6450	SWITCH,MICRO 11-314 04426	EA	1	1
19	70	XBFZZ	XB		XBFZZ				BRACKET,SWITCH MTG 10702-1 50603	EA	1	1
19	71	XBFZZ	XB		XBFZZ				PLATE,ADAPTER 10701-1 50603	EA	1	1
19	72	PAFZZ	PAOZZ		PAFZZ	-	.008	5950-01-018-0230	COIL 10353-940 50603	EA	1	1

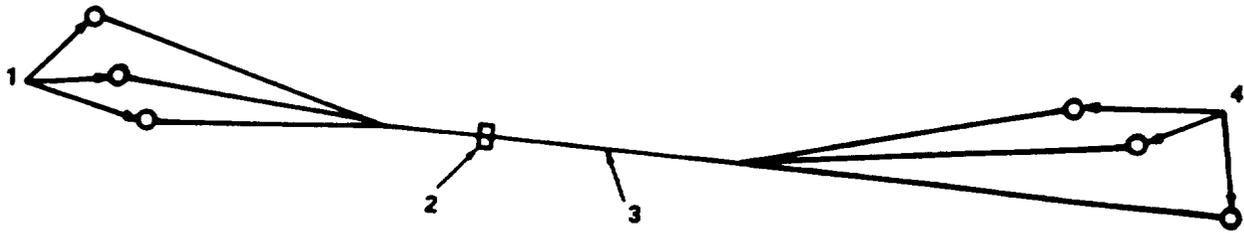

Figure 20. Reconnection board to contactor wiring harness.

TM9-6115-465-24P
 TO 35C2-3-446-4
 NAVFAC P-8-625-24P
 SL-4-06858B/06859D

(1) ILLUSTRATION A	(2) SMR CODE A	B	C	D	(3) A	B	(4) NATIONAL STOCK NUMBER	(5) DESCRIPTION REF NUMBER & MFR CODE	(6) USABLE ON CODE	U/M	(7) QTY INC IN UNITS	(8) USMC QTY PER EQUIP	
													B
20	MFOOF	AOO	XBGZZ	AFFZZ				WIRING HARNESS, RECONNECTION BOARD TO CONTACT 72-2225-2 30554 30554-72-2225-2 36024 MANUFACTURE FROM:		EA	1	1	
20	1	PAOZZ	PAOZZ	XBGZZ	PAFZZ	D	.050	5940-00-557-4338	TERMINAL, LUG MS25036-125 96906		EA	3	3
20	2	PAOZZ	PAOZZ	PAGZZ	PAFZZ	D	.008	5975-00-111-3208	STRAP, TIEDOWN MS3367-5-9 96906		EA	V	232
20	3	PAOZZ	PAOZZ	XBGZZ	PZFZZ	D	.080	6145-00-578-6595	WIRE, ELECTRICAL M5086/2-4-9 81349		FT	9	14
20	4	PAOZZ	PAOZZ	XBGZZ	PAFZZ	D	.050	5945-00-557-4345	TERMINAL, LUG MS25036-118 96906		EA	4	3

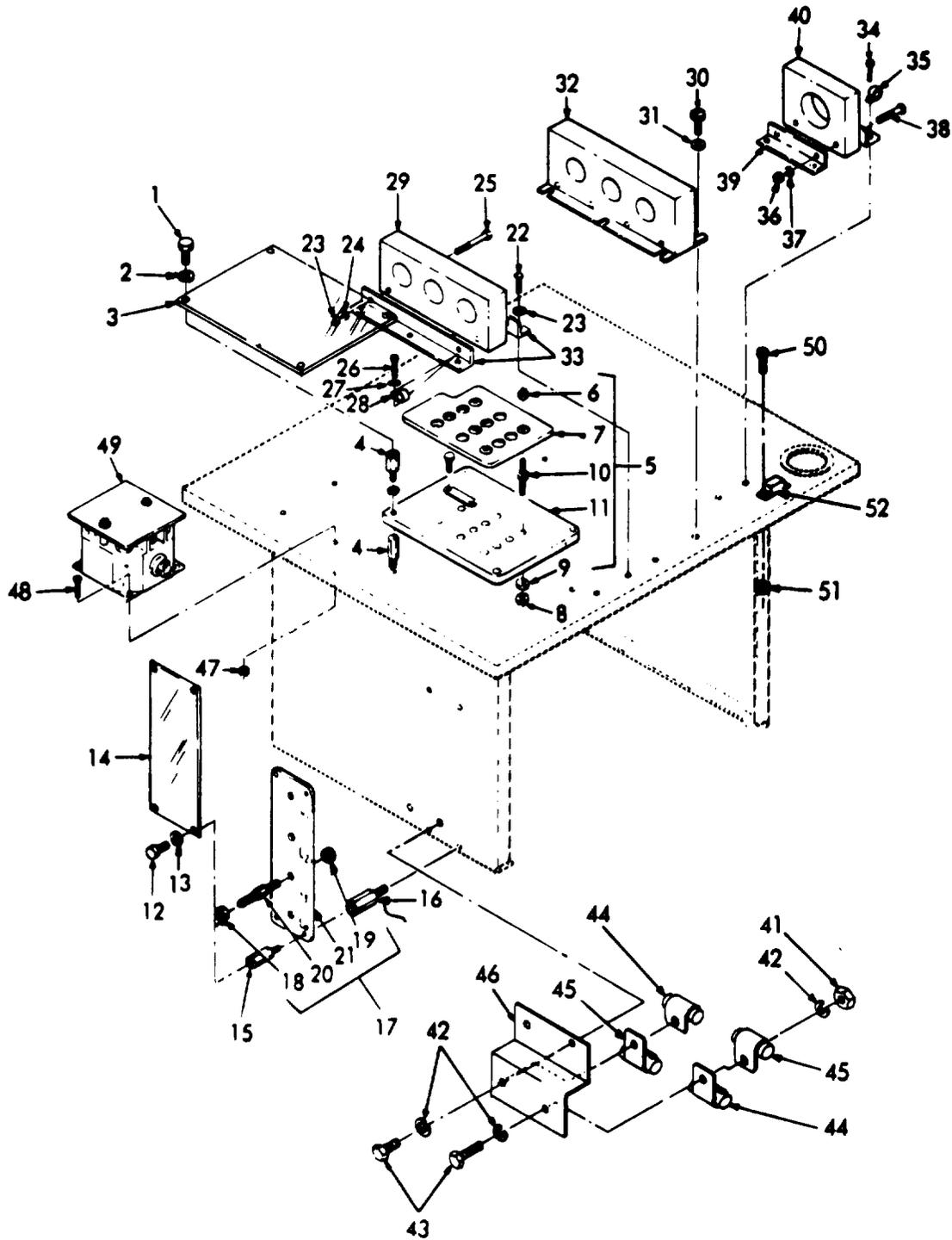

Figure 21. Reconnection board.

(1) ILLUSTRATION A FIG. NO.	(2) SMR CODE B ITEM NO.	(3) A ARMY	(3) B AIR FORCE	(3) C NAVY	(3) D USMC	(3) E SSI	(4) NATIONAL STOCK NUMBER	(5) DESCRIPTION REF NUMBER & MFR CODE	(6) USABLE ON CODE U/M	(7) QTY INC IN UNITS	(8) USMC QTY PER EQUIP
21	1	PAOZZ	PAOZZ	PAGZZ	PAFZZ	D	.008 5305-00-068-0500	SCREW,CAP,HEXAGON HEAD:COVER MTG MS90725-3 96906	EA	4	179
21	2	PAOZZ	PAOZZ	PAGZZ	PAFZZ	D	.010 5310-00-582-5965	WASHER,LOCK:COVER MTG MS35338-44 96906	EA	4	256
21	3	XBFZZ	MFO	XBGZZ	XBFZZ			COVER:VOLTAGE CHANGEOVER BOARD 72-2145 30554 30554-72-2145 36024	EA	1	1
21	4	XBFZZ	XB	XBGZZ	XBFZZ			STAND OFF:TERMINAL BOARD AND COVER 72-2098-1 30554 30554-72-2098-1 36024	EA	8	8
21	5	XBOZZ	AFO	AGGGG	APFZZ			TERMINAL BOARD ASSEMBLY:VOLTAGE CHANGEOVER 72-2237 30554 30554-72-2237 36024	EA	1	1
21	6	PAOZZ	PAOZZ	XBGZZ	PAFZZ	D	.008 5310-01-034-2835	NUT,HEXAGON:SELF-LOCKING MS51922-19 96906	EA	13	13
21	7	XBOZZ	PAOZZ	XBGZZ	PAFZZ			5940-00-606-4970 TERMINAL BOARD 72-2213 30554 30554-72-2213 36024	EA	1	1
21	8	PAOZZ	PAOZZ	XBGZZ	PAFZZ	D	.008 5310-00-897-6082	NUT,PLAIN,HEXAGON:TERMINAL STUD 72-2062-2 30554 MS35691-36 96906	EA	13	13
21	9	PAOZZ	PAOZZ	XBGZZ	PAFZZ	D	.008 5310-00-630-2383	NUT,PLAIN HEXAGON:TERMINAL STUD 72-2061-1 30554 TLF-3816-S-JAN 82458	EA	13	13
21	10	XBOZZ	PAOZZ	XBGZZ	PAFZZ	D	.008 5940-01-003-8579	STUD,TERMINAL:VOLTAGE CHANGEOVER 72-2236 30554 30554-72-2236 36024	EA	12	12
21	11	XBOZZ	PAOZZ	XBGZZ	PAFZZ			5940-00-606-4972 TERMINAL,BOARD,RECONNECTION 72-2214 30554 30554-72-2214 36024	EA	1	1
21	12	PAFZZ	PAOZZ	PAGZZ	PAFZZ	D	.008 5305-00-068-0500	SCREW,CAP,HEXAGON LOAD:LOAD TERMINAL COVER MTG MS90725-3 96906	EA	6	179
21	13	PAFZZ	PAOZZ	PAGZZ	PAFZZ	D	.008 5310-00-582-5965	WASHER,LOCK:MAIN LOAD TERMINAL COVER MTG MS35338-44 96906	EA	6	256
21	14	XBFZZ	MFO	XBGZZ	XBFZZ			COVER TERMINAL:RECONNECTION BOARD 72-2144 30554 30554-72-2144 36024	EA	1	1
21	15	XBFZZ	XB	XBGZZ	PAFZZ			STAND OFF:COVER 72-2098-3 30554 30554-72-2098-3 36024	EA	6	6
21	16	XBFZZ	XB	XBGZZ	XBFZZ			STAND OFF:TERMINAL BOARD 72-2098-2 30554 30554-72-2098-2 36024	EA	6	6
21	17	PAFZZ	AFO	AHHHH	APFZZ			5940-01-191-8111 BOARD ASSEMBLY,TERMINAL:MAIN LOAD 72-2221-2 30554 30554-72-2221-2 36024	EA	1	1
21	18	PAFZZ	PAOZZ	XBGZZ	PAFZZ	D	.008 5310-01-017-3676	NUT,PLAIN HEXAGON:TERMINAL STUD 72-2061-2 30554 TLF-1213-B-JAM 82458	EA	4	4

(1) ILLUSTRATION		(2) SMR CODE				(3)		(4)	(5)	(6)	(7)	(8)
A	B	A	B	C	D	A	B	NATIONAL STOCK NUMBER	DESCRIPTION	USABLE ON CODE	QTY INC IN UNITS	USMC QTY PER EQUIP
FIG. NO.	ITEM NO.	ARMY	AIR FORCE	NAVY	USMC	SSI	REPL FACTOR		REF NUMBER & MFR CODE	U/M		
21	19	PAFZZ	PAOZZ	XBGZZ	PAFZZ	D	.008	5130-00-897-6082	NUT HEXAGON: TERMINAL STUD 72-2062-2 30554 MS35691-36 96906	EA	4	13
21	20	PAFZZ	PAOZZ	XBGZZ	PAOZZ	D	.050	5940-00-237-2703	STUD, TERMINAL: MAIN LOAD 69-692-4 30554 MS39347-5 96906	EA	4	4
21		MFOZZ	AFO	AGZZ	APFZZ	-	-	9505-01-049-0144	CLIP, TERMINAL MANUFACTURE FROM: WIRE 0.050 IN. DIA			
21	21	XAFZZ	XB	XBHZZ	XBFZZ	-	-		BOARD TERMINAL: MAIN LOAD 72-2215-2 30554 30554-72-2215-2 36024	EA	1	1
21	22	PAOZZ	PAOZZ	PAGZZ	PAFZZ	D	.008	5305-00-191-6226	SCREW, WASHER: TRANSFORMER BRACKET MTG 69-662-64 30554 P15121-64 45722	EA	3	42
21	23	PAFZZ	PAOZZ	PAGZZ	PAFZZ	D	.008	5310-00-761-6882	NUT, PLAIN HEXAGON: TRANSFORMER TO BRACKET MTG MS51967-2 96906	EA	4	109
21	24	PAFZZ	PAOZZ	APGZZ	PAFZZ	D	.010	5310-00-582-5965	WASHER, LOCK: TRANSFORMER TO BRACKET MTG MS35338-44 96906	EA	4	256
21	25	PAFZZ	PAOZZ	PAGZZ	PAFZZ	D	.008	5305-00-071-2239	SCREW, CAP, HEXAGON HEAD: TRANSFORMER TO BRACKET MTG MS90725-12 96906	EA	4	4
21	26	PAFZZ	PAOZZ	PAGZZ	PAFZZ	D	.008	5305-00-191-6226	SCREW, WASHER: CLAMP AND BRACKET MTG 69-662-64 30554 P15121-64 45722	EA	3	42
21	27	PAFZZ	PAOZZ	PAGZZ	PAFZZ	D	.010	5310-00-809-8544	WASHER, FLAT MS27183-7 96906	EA	3	17
21	28	PAFZZ	PAOZZ	XBGZZ	PAFZZ	D	.008	5340-00-968-1162	CLAMP LOOP CABLE MS21333-113 96906	EA	1	3
21	29	PAFZZ	PAOZZ	PAGZZ	PAFZZ	-	.040	5950-00-603-6989	TRANSFORMER 72-2208 30554 14616 62429	EA CLA, CLB CZN, CZM	1	1
21	29	PAFZZ	PAOZZ	PAGZZ	PAFZZ	-	.040	5950-00-603-6990	TRANSFORMER 72-2216 30554 14615 62429	EA CLC, DGG	1	1
21	30	PAFZZ	PAOZZ	PAGZZ	PAFZZ	D	.008	5305-00-191-6226	SCREW, WASHER: TRANSFORMER MTG 69-662-64 30554 P15121-64 45722	EA	6	42
21	31	PAFZZ	PAOZZ	PAGZZ	PAFZZ	D	.010	5310-00-809-8544	WASHER, FLAT: TRANSFORMER MTG MS27183-7 96906	EA	6	17
21	32	PAFZZ	PAOZZ	PAGZZ	PAFZZ	-	.040	5950-00-024-1000	TRANSFORMER AND BRACKET 70-1172 30554 30554-70-1172 36024	EA	1	1
21	33	XBZZ	MFO	XBGZZ	XBZZ	-	-		BRACKET TRANSFORMER 72-2058 30554 30554-72-2058 36024	EA	2	2
21	34	PAFZZ	PAOZZ	PAGZZ	PAFZZ	D	.008	5305-00-191-6226	SCREW, WASHER: BRACKET MTG 69-662-64 30554 P15121-64 45722	EA	4	42
21	35	PAFZZ	PAOZZ	XBGZZ	PAFZZ	D	.008	5340-00-968-1162	CLAMP LOOP CABLE MS21333-113 96906	EA	1	3

(1) ILLUSTRATION		(2) SMR CODE				(3)		(4) NATIONAL STOCK NUMBER	(5) DESCRIPTION	(6) USABLE ON CODE	(7) QTY INC IN UNITS	(8) USMC QTY PER EQUIP
A FIG. NO.	B ITEM NO.	A ARMY	B AIR FORCE	C NAVY	D USMC	A SSI	B REPL FACTOR	REF NUMBER & MFR CODE	U/M			
21	36	PAFZZ	PAOZZ	PAGZZ	PAGZZ	D	.008	5310-00-761-6882 NUT,PLAIN,HEXAGON:TRANSFORMER MTG MS51967-2 96906	EA	2	109	
21	37	PAFZZ	PAOZZ	PAGZZ	PAFZZ	D	.010	5310-00-582-5965 WASHER,LOCK:TRANSFORMER MTG MS35338-44 96906	EA	2	256	
21	38	PAFZZ	PAOZZ	XBGZZ	PAFZZ	D	.008	5305-00-071-2511 SCREW,CAP,HEXAGON HEAD: TRANS- FORMER MTG MS90728-14 96906	EA	2	4	
21	39	XBGZZ	MFO	XBGZZ	XBFZZ	D		BRACKET,TRANSFORMER 72-2059 30554 30554-72-2059 36024	EA	2	2	
21	40	PAFZZ	PAOZZ	PAGZZ	PAFZZ		.040	5950-00-600-0844 TRANSFORMER,CURRENT CROSS,50/60 HZ 72-2230 30554 14613 62429	CLA,CLB CZN,CZM	EA	1	1
21	40	PAFZZ	PAOZZ	PAGZZ	PAFZZ		.040	5950-01-010-0007 TRANSFORMER,CURRENT, CROSS,400 HS 72-2229 30554 14614 62429	CLC,DGG	EA	1	1
21	41	PAFZZ	PAOZZ		PAFZZ	D	.008	5310-00-696-5173 NUT,WASHER ASSEMBLED 69-561-5 30554 511-251800-00 78189	CZN,CZM DGG	EA	2	9
21	42	PAFZZ	PAOZZ		PAFZZ	D	.010	5310-00-067-6357 WASHER,LOCK MS45904-69 96906	CZN,CZM DGG	EA	4	19
21	43	PAFZZ	PAOZZ		PAFZZ	D	.008	5305-01-078-5064 SCREW,WASHER ASSEMBLED 69-662-78 30554 P15121-78 45722	CZN,CZM	EA	3	4
21	44	PAFZZ	PAOZZ		PAFZZ		.050	5910-00-577-1348 CAPACITOR CA37KFW103 81349	CZN,CZM DGG	EA	2	4
21	45	PAFZZ	PAOZZ		PAFZZ		.050	5910-00-577-1349 CAPACITOR CZ36KFW103 81349	CZN,CZM DGG	EA	2	4
21	46	XBFZZ	MFO		XBFZZ			BRACKET,RFI CAPACITOR 77-500 30554	CZN,CZM DGG	EA	1	1
21	47	PAFZZ	PAOZZ	PAOZZ	PAFZZ	D	.008	5310-00-934-9751 NUT,PLAIN,HEXAGON:MAIN LOAD CONTRACTOR MTG MS35650-302 96906	EA	4	7	
21	48	PAFZZ	PAOZZ	PAOZZ	PAFZZ	D	.008	5305-00-191-6226 SCREW,WASHER:MAIN LOAD CONTRACTOR MTG 69-662-64 30554 P15121-64 45722	EA	4	42	
21	49	PAOFF	PAOFF	PBHHH	PAFFF		700	5945-00-007-1147 CONTRACTOR ASSEMBLY,MAIN 70-501-1 30554 B301EA 74063	EA	1	1	
21	50	PAFZZ	PAOZZ		PAFZZ	D	.008	5305-01-101-8526 SCREW/WASHER ASSY 69-662-66 30554	DGG	EA	2	2
21	51	PAFZZ	PAOZZ		PAFZZ	D	.008	NUT,PLAIN,HEXAGON MS35206-32 96906	DGG	EA	2	2
21	52	XBFZZ	XB		XBFZZ			BOARD,TERMINAL 39TB2 81349	DGG	EA	1	1

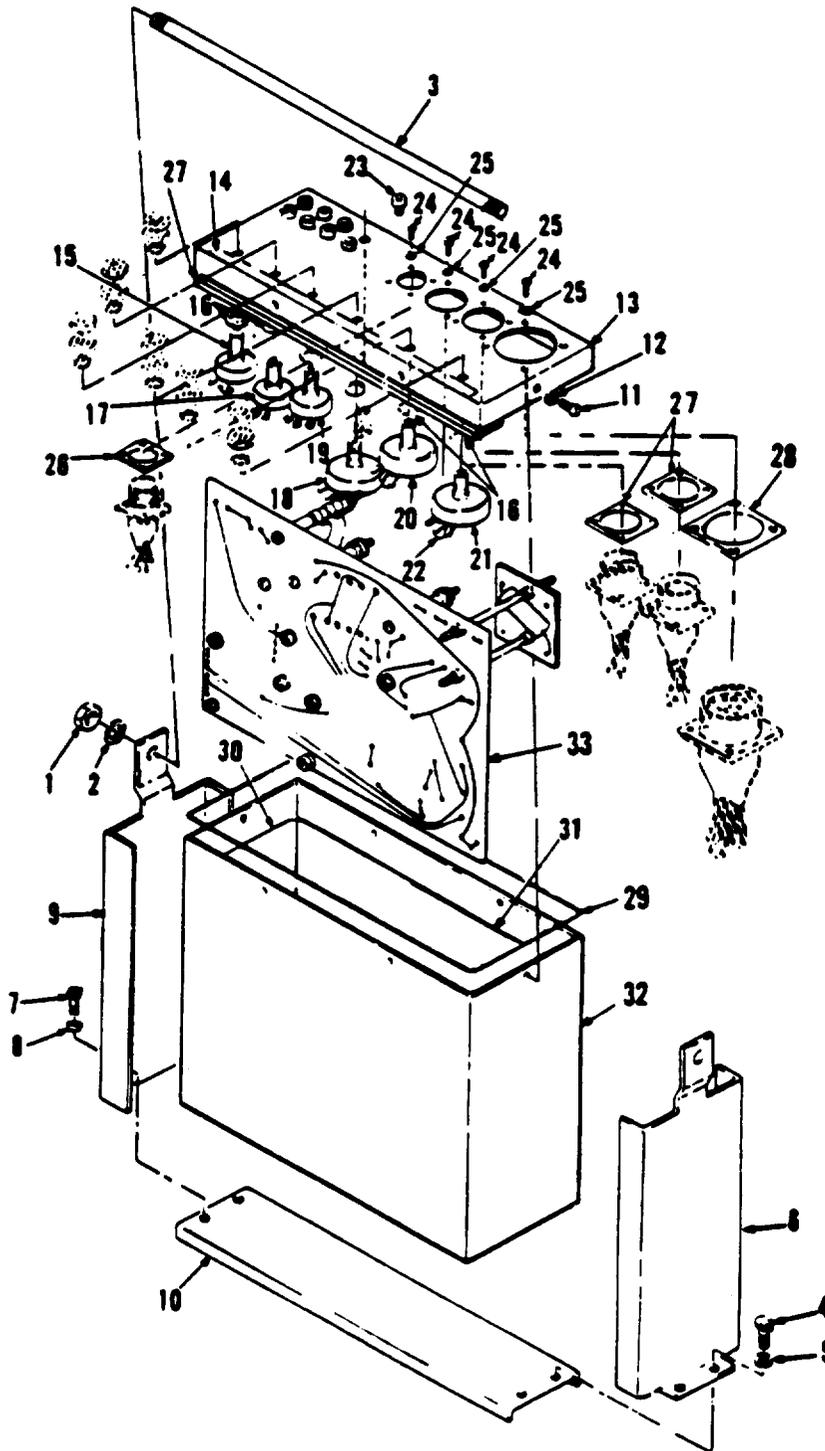

Figure 22. Governor control unit. (sheet 1 of 3)

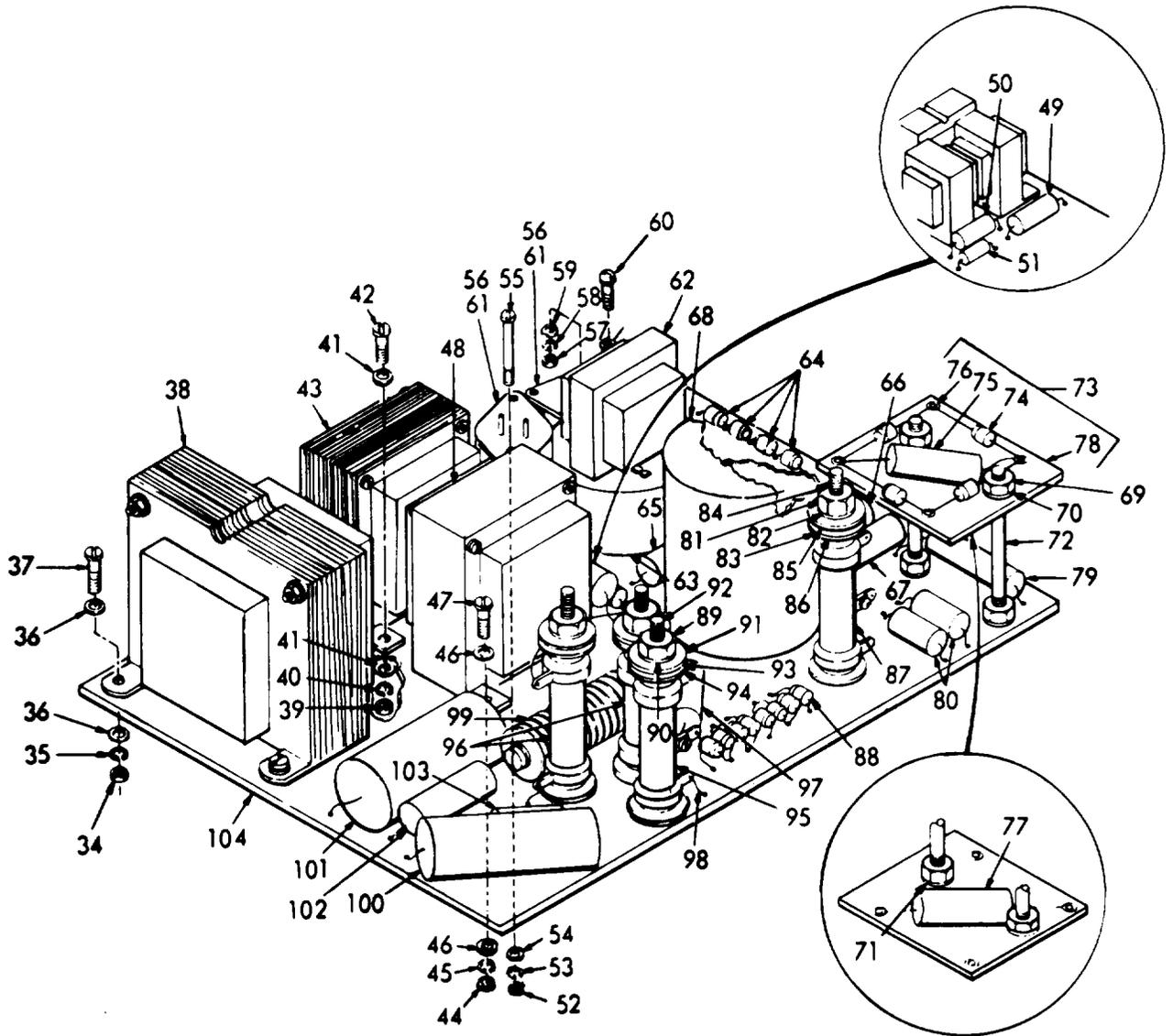

Figure 22. Governor control unit. (sheet 2 of 3)

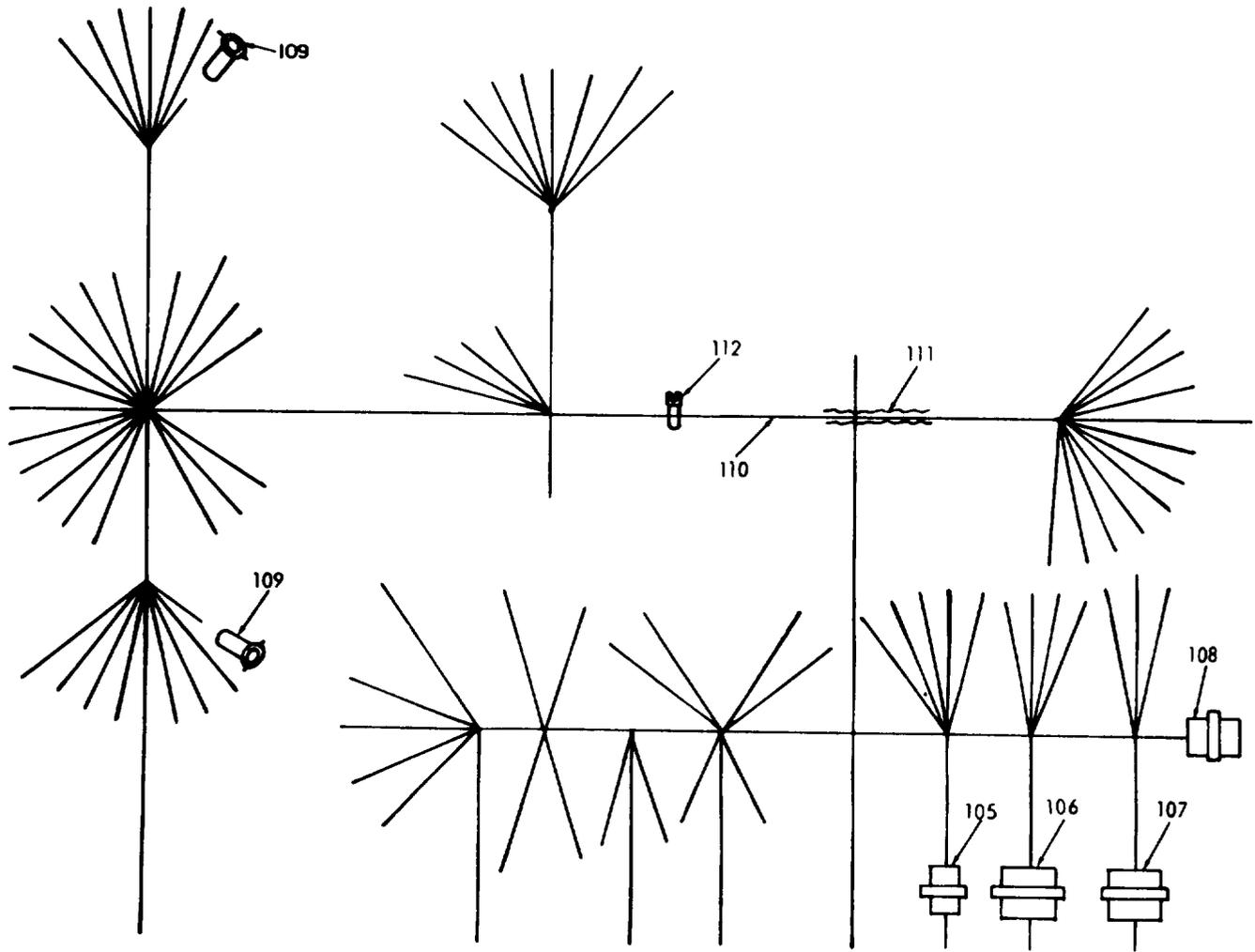

Figure 22. Governor control unit. (sheet 3 of 3)

(1) ILLUSTRATION A FIG. NO.	(2) SMR CODE B ITEM NO.	(3) A ARMY	(3) B AIR FORCE	(3) C NAVY	(3) D USMC	(3) A SSI	(2) B REPL FACTOR	(4) NATIONAL STOCK NUMBER	(5) DESCRIPTION REF NUMBER & MFR CODE	(6) USABLE ON CODE U/M	(7) QTY INC IN UNITS	(8) USMC QTY PER EQUIP
GROUP 11-GOVERNOR CONTROL UNIT												
22	1	PAFZZ	PAOZZ	PAOZZ	PAFZZ	D	.008	5310-00-732-0558	NUT,PLAIN,HEXAGON: THREADED ROD MS51967-8 96906	CLB,CLC CZM,DGG	EA	2
22	2	PAFZZ	PAOZZ	PAGZZ	PAFZZ	D	.010	5310-00-637-9541	WASHER,LOCK:THREADED ROD MS35338-46 96906	CLB,CLC CZM,DGG	EA	2
22	3	XBFZZ	XC	XBGZZ	XBFZZ				ROD,THREADED:GOVERNOR HOLDDOWN 72-2067-2 30554 30554-72-2067-2 36024	CLB,CLC CZM,DGG	EA	1
22	4	PAFZZ	PAOZZ	PAGZZ	PAFZZ	D	.008	5305-00-068-0502	SCREW,CAP,HEXAGON HEAD: BRACKET MTG MS90725-6 96906	CLB,CLC CZM,DGG	EA	2
22	5	PAFZZ	PAOZZ	PAGZZ	PAFZZ	D	.010	5310-00-582-5965	WASHER,LOCK:BRACKET MTG MS35338-44 96906	CLB,CLC CZM,DGG	EA	2
22	6	XBFZZ	XB	XBGZZ	XBFZZ				BRACKET,MOUNTING 72-2064 30554	CLB,CLC CZM,DGG	EA	1
22	7	PAFZZ	PAOZZ	PAGZZ	PAFZZ	D	.008	5305-00-068-0502	SCREW,CAP,HEXAGON HEAD: BRACKET MTG MS90725-6 96906	CLB,CLC CZM,DGG	EA	2
22	8	PAFZZ	PAOZZ	PAGZZ	PAFZZ	D	.010	5310-00-582-5965	WASHER,LOCK:BRACKET MTG MS35338-44 96906	CLB,CLC CZM,DGG	EA	2
22	9	XBFZZ	XC	XBGZZ	XBFZZ				BRACKET MOUNTING 72-2068 30554 30554-72-2068 36024	CLB,CLC	EA	1
22	10	XBFZZ	XC	XBGZZ	XBFZZ				BRACKET MOUNTING 72-2063 30554 30554-72-2063 36024	CLB,CLC CZM,DGG	EA	1
22		PAFHH	PAOFF	PBGGG	PAFHH		.250	6110-00-202-2891	CONTROL UNIT,GOVERNOR 69-784-2 30554 69-700 12670 (SAME AS CONTROL UNIT,NSN 6115-00- 222-8246,EXCEPT WHERE INDIVIDUAL COMPONENTS ARE ANNOTATED)	CLB,CZM	EA	1
22		PAFHH	PAOFF	PBGGG	PAFHH		.250	6115-00-222-8246	CONTROL UNIT 69-784-1 30554 69-800 12670	CLC,DGG	EA	1
22	11	PAFZZ	PAOZZ	XBGZZ	PAHZZ	D	.008	5305-00-889-3002	SCREW,MACHINE:PANEL MTG MS35206-242 96906	CLB,CLC CZM,DGG	EA	6
22	12	PAFZZ	PAOZZ	PAGZZ	PAHZZ	D	.010	5310-00-596-7693	WASHER,LOCK:PANEL MTG MS35335-31 96906	CLB,CLC CZM,DGG	EA	6
22	13	XBGZZ	XC	XBGZZ	XBHZZ				PANEL,CONTROL BOX 69-726 30554	CLB,CLC CZM,DGG	EA	1
22	14	XBFZZ	XC	XCGZZ	MDOZZ				PLATE,IDENTIFICATION:CONTROL UNIT 69-711 30554	CLB,CLC CZM,DGG	EA	1
22	15	PAFZZ	PAOZZ	PAGZZ	PAHZZ		.050	5905-00-378-0250	RESISTOR,VARIABLE 69-738-6 3-554 RA2UTAS8103A 81349	CLB,CLC CZM,DGG	EA	1
22	16	PAFZZ	PAOZZ	PAGZZ	PAHZZ	D	.010	5330-00-536-6908	WASHER,SEALING:RESISTOR MTG NAS 1598-6 80205	CLB,CLC CZM,DGG	EA	6

(1) ILLUSTRATION		(2) SMR CODE				(3)		(4)	(5)	(6)	(7)	(8)	
A	B	A	B	C	D	A	B	NATIONAL STOCK NUMBER	DESCRIPTION	USABLE ON CODE	U/M	QTY INC IN UNITS	USMC QTY PER EQUIP
FIG. NO.	ITEM NO.	ARMY	AIR FORCE	NAVY	USMC	SSI	REPL FACTOR		REF NUMBER & MFR CODE				
22	17	PAFZZ	PAOZZ	PAGZZ	PAHZZ		.050	5905-00-165-3280	RESISTOR,VARIABLE 69-738-2 30554 2P1181 11237	CLB,CLC CZM,DGG	EA	1	
22	18	PAFZZ	PAOZZ	PAGZZ	PAHZZ		.050	5905-00-001-3050	RESISTOR,VARIABLE 69-738-5 30554 RA20TASB501A 81349	CLB,CLC CZM,DGG	EA	1	
22	19	PAFZZ	PAOZZ	PAGZZ	PAHZZ		.050	5905-00-357-2810	RESISTOR,VARIABLE 69-738-1 30554 1P1046 11237	CLB,CLC CZM,DGG	EA	1	
22	20	PAFZZ	PAOZZ	PAGZZ	PAHZZ		.050	5905-00-371-6626	RESISTOR,VARIABLE 69-738-4 30554 R430TASB102A 81349	CLB,CLC CZM,DGG	EA	1	
22	21	PAFZZ	PAOZZ	PAGZZ	PAHZZ		.050	5905-00-371-6625	RESISTOR,VARIABLE 69-738-3 30554 RA30TASB103A 81349	CLB,CLC CZM,DGG	EA	1	
22	22	PAFZZ	XC	PAGZZ	XBHZZ				WIRE,ELECTRICAL QOW343DTYES18AWGW 81348	CLB,CLC CZM,DGG	FT	V	
22	23	PAFZZ	PAOZZ	PAGZZ	PAHZZ	D	.005	5935-00-702-4199	JACK,TIP:TEST M39024-10-02 81349	CLB,CLC CZM,DGG	EA	8	
22	24	PAFZZ	PAOZZ	XBGZZ	PAHZZ	D	.005	5305-00-984-6191	SCREW,MACHINE:WIRING HARNES MTG MS35206-243 96906	CLB,CLC CZM,DGG	EA	16	
22	25	PAFZZ	PAOZZ	PAGZZ	PAHZZ			5310-00-045-3299	WASHER,LOCK:WIRING HARNES MTG MS35338-42 96906	CLB,CLC CZM,DGG	EA	16	
22	26	PAFZZ	PAOZZ	PCGZZ	PAHZZ		.060	5330-00-060-1679	GASKET:RUBBER MS51007-2 96906	CLB,CLC CZM,DGG	EA	1	
22	27	PAFZZ	PAOZZ	PCGZZ	PAHZZ		.060	5330-00-079-7839	GASKET:RUBBER MS51007-4 96906	CLB,CLC CZM,DGG	EA	2	
22	28	PAFZZ	PAOZZ	PCGZZ	PAHZZ		.060	5330-00-836-4356	GASKET:RUBBER MS51007-8 96906	CLB,CLC CZM,DGG	EA	1	
22	29	PAFZZ	PAOZZ	PAGZZ	PAHZZ		.060	5330-00-379-4626	GASKET STRIP UCL16 29226 72-503 30554	CLB,CLC CZM,DGG	FT	V	
22	30	XBFPZZ	XC	XBGZZ	XBHZZ				INSULATION,BOX MIL123053-2CL1 81349	CLB,CLC CZM,DGG	EA	1	
22	31	XBFPZZ	XC	XBGZZ	XBHZZ				INSULATION BOX MIL123053-2CL1 81349	CLB,CLC CZM,DGG	EA	1	
22	32	XBFPZZ	XC	XBGZZ	XBHZZ				CABINET:CONTROL 69-710 30554	CLB,CLC CZM,DGG	EA	1	
22	33	PAHHH	PAOFF	PBGGG	PAHHH		.040	6115-00-204-1729	BOARD ASSEMBLY,COMPONENT CIRCUIT 69-736 30554	CLB,CZM	EA	1	
22	33	PAHHH	PAOFF	PBGGG	PAHHH		.040	6115-00-204-1728	BOARD ASSEMBLY,COMPONENT CIRCUIT 69-801 12670	CLC,DDG	EA	1	
22	34	PAHZZ	PAOZZ	PAGZZ	PAHZZ	D	.008	5310-00-934-9747	NUT,PLAIN,HEXAGON: TRANSFORMER MTG MS35649-262 96906	CLB,CZM CLC,DGG	EA	2	
22	35	PAHZZ	PAOZZ	PAGZZ	PAHZZ	D	.010	5310-00-045-4007	WASHER,LOCK:TRANSFORMER MTG MS35338-41 96906	CLB,CLC CZM,DGG	EA	2	

(1) ILLUSTRATION		(2) SMR CODE				(3)		(4) NATIONAL STOCK NUMBER	(5) DESCRIPTION	(6) USABLE ON CODE	(7) QTY INC IN UNITS	(8) USMC QTY PER EQUIP
A FIG. NO.	B ITEM NO.	A ARMY	B AIR FORCE	C NAVY	D USMC	A SSI	B REPL FACTOR	REF NUMBER & MFR CODE	U/M			
22	36	PAHZZ	PAOZZ	PAGZZ	PAHZZ	D	.010	5310-00-983-8483 WASHER, FLAT: TRANSFORMER MTG MS27183-5 96906	CLB, CLC CZM, DGG	EA	4	
22	37	PAHZZ	PAOZZ	PAGZZ	PAHZZ	D	.008	5305-00-579-2139 SCREW, MACHINE MS35265-30 96906	CLB, CLC CZM, DGG	EA	2	
22	38	PAHZZ	PAOZZ	PAGZZ	PAHZZ		.009	5950-00-148-6066 TRANSFORMER 69-726 30554 TR1266 73662	CLB, CZM	EA	1	
22	38	PAHZZ	PAOZZ	PAGZZ	PAHZZ		.009	5950-00-116-3613 TRANSFORMER 69-810 30554 TR183 73662	CLC, DGG	EA	1	
22	39	PAHZZ	PAOZZ	PAGZZ	PAHZZ	D	.008	5310-00-934-9747 NUT, PLAIN, HEXAGON: REACTOR FILTER MS35649-262 96906	CLB, CLC CZM, DGG	EA	2	
22	40	PAHZZ	PAOZZ	PAGZZ	PAHZZ	D	.010	5310-00-045-4007 WASHER, LOCK: REACTOR FILTER MTG MS35338-41 96906	CLB, CLC CZM, DGG	EA	2	
22	41	PAHZZ	PAOZZ	PAGZZ	PAHZZ	D	.010	5310-00-983-8483 WASHER, FLAT: REACTOR FILTER MTG MS27183-5 96906	CLB, CLC CZM, DGG	EA	4	
22	42	PAHZZ	PAOZZ	PAGZZ	PAHZZ	D	.008	5305-00-579-2139 SCREW, MACHINE: REACTOR FILTER MTG MS35265-30 96906	CLB, CLC CZM, DGG	EA	2	
22	43	PAHZZ	PAOZZ	PAGZZ	PAHZZ		.034	5950-00-148-6067 FILTER, REACTOR 69-727-1 30554 TR1251 73662	CLB, CZM	EA	1	
22	43	PAHZZ	PAOZZ	PAGZZ	PAHZZ		.034	5950-00-148-6069 FILTER, REACTOR TR1005 73662	CLC, DGG	EA	1	
22	44	PAHZZ	PAOZZ	PAGZZ	PAHZZ	D	.008	5310-00-934-9747 NUT, PLAIN, HEXAGON: FILTER REACTION MTG MS35649-262 96906	CLB, CLC CZM, DGG	EA	2	
22	45	PAHZZ	PAOZZ	PAGZZ	PAHZZ	D	.010	5310-00-045-4007 WASHER, LOCK: FILTER REACTOR MTG MS35338-41 96906	CLB, CLC CZM, DGG	EA	2	
22	46	PAHZZ	PAOZZ	PAGZZ	PAHZZ	D	.010	5310-00-983-8483 WASHER, FLAT: FILTER REACTOR MTG MS27183-5 96906	CLB, CLC CZM, DGG	EA	4	
22	47	PAHZZ	PAOZZ	PAGZZ	PAHZZ	D	.008	5305-00-579-2139 SCREW, MACHINE: FILTER REACTOR MTG MS35265-30 96906	CLB, CLC CZM, DGG	EA	2	
22	48	PAHZZ	PAOZZ	PAGZZ	PAHZZ		.034	5950-00-116-3472 FILTER, REACTOR 69-727-2 30554 TR1252 73662	CLB, CZM	EA	1	
22	48	PAHZZ	PAOZZ	PAGZZ	PAHZZ		.034	5950-00-116-3471 FILTER, REACTOR 69-811-2 30554 TR1006 73662	CLB, DGG	EA	1	
22	49	PAHZZ	PAOZZ	PAGZZ	PAHZZ		.050	5950-00-359-4131 RESISTOR, FIXED 69-713-1 30554 K48181-15 63743	CLB, CLC CZM, DGG	EA	1	
22	50	PAHZZ	PAOZZ	PAGZZ	PAHZZ		.050	5910-00-060-9391 CAPACITOR, FIXED NLW50-50 14655 69-716 30554	CLB, CLC CZM, DGG	EA	1	

(1) ILLUSTRATION		(2) SMR CODE				(3)		(4) NATIONAL STOCK NUMBER	(5) DESCRIPTION	(6) USABLE ON CODE	U/M	(7) QTY INC IN UNITS	(8) USMC QTY PER EQUIP
A FIG. NO.	B ITEM NO.	A ARMY	B AIR FORCE	C NAVY	D USMC	A SSI	B REPL FACTOR	REF NUMBER & MFR CODE					
22	51	PAHZZ	PAOZZ	PAGZZ	PAHZZ		.050	5950-00-359-4132 RESISTOR, FIXED 69-713-5 30554 K48181-510 63743	CLB, CLC CZM, DGG	EA	1		
22	52	PAHZZ	PAOZZ	PAGZZ	PAHZZ	D	.008	5310-00-761-6882 NUT, PLAIN, HEXAGON: POWER TRANSISTOR MTG MS51967-2 96906	CLB, CLC CZM, DGG	EA	2		
22	53	PAHZZ	PAOZZ	PAGZZ	PAHZZ	D	.010	5310-00-582-5965 WASHER, LOCK: HEAT POWER TRANSISTOR MTG MS35338-44 96906	CLB, CLC	EA	2		
22	54	PAHZZ	PAOZZ	PAGZZ	PAHZZ	D	.010	5310-00-809-3078 WASHER, FLAT: POWER TRANSISTOR MTG MS27183-11 96906	CLB, CLC CZM, DGG	EA	2		
22	55	PAHZZ	PAOZZ	PAGZZ	PAHZZ	D	.008	5305-00-808-9977 SCREW, MACHINE POWER TRANSISTOR MTG MS35265-83 96906	CLB, CLC CZM, DGG	EA	2		
22	56	PAHZZ	PAOZZ	PAGZZ	PAHZZ		.050	5961-00-929-5014 TRANSISTOR, POWER 2N3773 80131 69-719 30554	CLB, CLC CZM, DGG	EA	2		
22	57	PAHZZ	PAOZZ	PAGZZ	PAHZZ	D	.008	5310-00-934-9747 NUT, PLAIN, HEXAGON: HEAT SINK MTG MS35649-262 96906	CLB, CLC CZM, DGG	EA	2		
22	58	PAHZZ	PAOZZ	PAGZZ	PAHZZ	D	.010	5310-00-045-4007 WASHER, LOCK: HEAT SINK MTG MS35338-41 96906	CLB, CLC CZM, DGG	EA	2		
22	59	PAHZZ	PAOZZ	PAGZZ	PAHZZ	D	.010	5310-00-983-8483 WASHER, FLAT: HEAT SINK MTG MS27183-5 96906	CLB, CLC CZM, DGG	EA	4		
22	60	PAHZZ	PAOZZ	PAGZZ	PAHZZ	D	.008	5305-00-582-5807 SCREW, MACHINE: HEAT SINK MTG MS35265-28 96906	CLB, CLC CZM, DGG	EA	2		
22	61	XBHZZ	PAOZZ	XBGZZ	XBHZZ			5999-00-212-3555 HEAT SINK 69-702 30554 TXD079-137 98978	CLB, CLC CZM, DGG	EA	2		
22	62	PAHZZ	PAOZZ	PAGZZ	PAHZZ		.009	5950-00-116-3646 TRANSFORMER 69-734 30554 TW62530 02640	CLB, CLC CZM, DGG	EA	2		
22	63	PAHZZ	PAOZZ	PAGZZ	PAHZZ		.034	5950-00-116-3614 FILTER, REACTOR 69-718 30554 TW62510 02640	CLB, CZM	EA	1		
22	63	PAHZZ	PAOZZ	PAGZZ	PAHZZ		.034	5950-00-116-3616 REACTOR, FILTER 69-806 30554 TW62511 02640	CLC, DGG	EA	1		
22	64	PAHZZ	PAOZZ	PAGZZ	PAHZZ		.050	5961-00-998-6947 RECTIFIER 69-512 30554 JANIN4385 14433	CLB, CLC CZM, DGG	EA	4		
22	65	PAHZZ	PAOZZ	PAGZZ	PAHZZ		.050	5910-00-431-8036 CAPACITOR, FIXED 69-717-2 30554	CLB, CLC CZM, DGG	EA	2		
22	66	PAHZZ	PAOZZ	PAGZZ	PAHZZ		.050	5905-00-081-3919 RESISTOR, FIXED RW68V302 81349	CLB, CLC CZM, DGG	EA	2		
22	67	PAHZZ	PAOZZ	PAGZZ	PAHZZ		.050	5905-00-429-7153 RESISTOR, FIXED 69-713-3 30554 K481815100 63743	CLB, CLC CZM, DGG	EA	1		
22	68	PAHZZ	PAOZZ	PAGZZ	PAHZZ		.050	5950-00-116-3664 MAGAMP 69-735 30554 TW62514 02640	CLB, CLC CZM, DGG	EA	1		

(1) ILLUSTRATION		(2) SMR CODE				(3)		(4) NATIONAL STOCK NUMBER	(5) DESCRIPTION	(6) USABLE ON CODE	(7) QTY INC IN UNITS	(8) USMC QTY PER EQUIP
A FIG. NO.	B ITEM NO.	A ARMY	B AIR FORCE	C NAVY	D USMC	A SSI	B REPL FACTOR	REF NUMBER & MFR CODE	U/M			
22	69	PAHZZ	PAOZZ	PAGZZ	PAHZZ	D	.008	5310-00-934-9747 NUT, PLAIN, HEXAGON: PANEL MTG MS35649-262 96906	CLB, CLC CZM, DGG	EA	8	
22	70	PAHZZ	PAOZZ	PAGZZ	PAHZZ	D	.010	5310-00-045-4007 WASHER, LOCK: PANEL MTG MS35338-41 96906	CLB, CLC CZM, DGG	EA	8	
22	71	PAHZZ	PAOZZ	PAGZZ	PAHZZ	D	.010	5310-00-983-8483 WASHER, FLAT MS27183-5 96906	CLB, CLC CZM, DGG	EA	8	
22	72	XBHZZ	PAOZZ	XBGZZ	XBHZZ			STUD, PLAIN: PANEL MTG 69-516 30554	CLB, CLC CZM, DGG	EA	2	
22	73	XBHZZ	AOO	AGGGG	AHHZZ			6110-00-370-5864 PANEL ASSEMBLY 69-715 30554	CLB, CZM	EA	1	
22	73	XBHZZ	AOO	AGGGG	AHHZZ			PANEL ASSEMBLY 69-805 30554	CLC, DGG	EA	1	
22	74	PAHZZ	PAOZZ	PAGZZ	PAHZZ	0	.050	5961-00-998-6947 RECTIFIER 69-512 30554 IN4385 14433	CLB, CLC	EA	4	
22	75	PAHZZ	PAOZZ	PAGZZ	PAHZZ		.050	5905-00-429-7153 RESISTOR, FIXED 69-713-3 30554 K48181-5100 63743	CLB, CZM	EA	1	
22	75	PAHZZ	PAOZZ	PAGZZ	PAHZZ		.050	5905-00-333-8368 RESISTOR, FIXED 69-713-4 30554 K48181-3500 63743	CLC, DGG	EA	1	
22	76	XBHZZ	PAOZZ	XBGZZ	XBHZZ			TERMINAL, PANEL 69-705 30554 422A031 18310	CLB, CLC CZM, DGG	EA	4	
22	77	PAHZZ	PAOZZ	PAGZZ	PAHZZ		.050	5910-00-007-5627 CAPACITOR, FIXED 69-717-1 30554	CLB, CZM	EA	1	
22	78	XBHZZ	MFO	XBGZZ	XBHZZ			PLATE 69-704 30554	CLB, CLC CZM, DGG	EA	1	
22	79	PAHZZ	PAOZZ	PAGZZ	PAHZZ		.050	5910-00-226-8109 CAPACITOR, FIXED 69-717-3 30554	CLB, CLC CZM, DGG	EA	1	
22	80	PAHZZ	PAOZZ	PAGZZ	PAHZZ	0	.050	5905-00-429-7153 RESISTOR 69-713-3 30554 K48181-5100 63734	CLB, CLC CZM, DGG	EA	3	
22	81	PAHZZ	PAOZZ	PAGZZ	PAHZZ	D	.008	5310-00-934-9747 NUT, PLAIN, HEXAGON: RESISTOR MTG MS35649-262 96906	CLB, CLC CZM, DGG	EA	2	
22	82	PAHZZ	PAOZZ	PAGZZ	PAHZZ	D	.010	5310-00-045-4007 WASHER, LOCK: RESISTOR MTG MS35338-41 96906	CLB, CLC CZM, DGG	EA	2	
22	83	PAHZZ	PAOZZ	PAGZZ	PAHZZ	D	.010	5310-00-983-8483 WASHER, FLAT: RESISTOR MTG M28183-5 96906	CLB, CLC CZM, DGG	EA	2	
22	84	PAHZZ	PAOZZ	XBGZZ	PAHZZ	D	.008	5305-00-753-4362 SCREW, MACHINE: RESISTOR MTG MS35223-62 96906	CLB, CLC CZM, DGG	EA	4	
22	85	XBHZZ	XB	XBGZZ	PAHZZ		.010	5310-00-596-4694 WASHER 72-502-2 30554 6000 44655	CLB, CZM	EA	4	
22	86	XBHZZ	XB	XBGZZ	PAHZZ	D	.010	5970-00-376-3107 WASHER, MICA 70-512-3 30554	CLB, CLC CZM, DGG	EA	4	
22	87	PAHZZ	PAOZZ	PAGZZ	PAHZZ		.050	5905-00-642-2162 RESISTOR, FIXED RW32V501 81349	CLB, CLC CZM, DGG	EA	2	

(1) ILLUSTRATION		(2) SMR CODE				(3)		(4) NATIONAL STOCK NUMBER	(5) DESCRIPTION	(6) USABLE ON CODE	(7) QTY INC IN UNITS	(8) USMC QTY PER EQUIP
A FIG. NO.	B ITEM NO.	A ARMY	B AIR FORCE	C NAVY	D USMC	A SSI	B REPL FACTOR	REF NUMBER & MFR CODE	U/M			
22	88	PAHZZ	PAOZZ	PAGZZ	PAHZZ	-	.050	5961-00-998-6947 RECTIFIER 69-512 30554 JANIN4385 14433	CLB, CLC, CZM, DGG	EA	8	
22	89	PAHZZ	PAOZZ	PAGZZ	PAHZZ	D	.008	5310-00-934-9747 NUT, PLAIN, HEXAGON; RESISTOR MTG MS35649-262 96906	CLB, CLC CZM, DGG	EA	1	
22	90	PAHZZ	PAOZZ	PAGZZ	PAHZZ	D	.010	5310-00-045-4007 WASHER, LOCK; RESISTOR MTG MS35338-41 96906	CLB, CLC CZM, DGG	EA	1	
22	81	PAHZZ	PAOZZ	PAGZZ	PAHZZ	D	.010	5310-00-983-8403 WASHER, FLAT; RESISTOR MTG MS27183-5 96906	CLB, CLC CZM, DGG	EA	1	
22	92	PAHZZ	PAOZZ	XBGZZ	PAHZZ	D	.008	6305-00-753-4362 SCREW MACHINE FFS92TYPE1STYLE9S 81348	CLB, CLC CZM, DGG	EA	2	
22	93	XBHZZ	XB	XXGZZ	XBHZZ			WASHER, FLAT 72-502-1 30554 6007 44655	CLB, CLC CZM, DGG	EA	4	
22	94	PAHZZ	PAOZZ	XBGZZ	PAHZZ	D	.010	5970-00-378-9939 WASHER, MICA 70-512-2 30554	CLB, CLC CZM, DGG	EA	4	
22	95	PAHZZ	PAOZZ	PAGZZ	PAHZZ		.050	5905-00-378-0840 RESISTOR, ADJUSTABLE 69-733-2 30554 2DA1250 11502	CLB, CLC CZM, DGG	EA	2	
22	96	PAHZZ	PAOZZ	PAGZZ	PAHZZ		.050	5905-00-642-2162 RESISTOR, FIXED RW32V501 81349	CLB, CLC CZM, DGG	EA	2	
22	97	PAHZZ	PAOZZ	PAGZZ	PAHZZ	D	.080	6145-00-643-0647 WIRE, ELECTRICAL M16878-2-20-9 81349	CLB, CLC CZM, DGG	FT	V	
22	98	PAHZZ	PAOZZ	XBGZZ	PAHZZ	D	.080	6145-00-669-6642 WIRE, ELECTRICAL M1116878-2-20-9 81349	CLB, CLC CZM, DGG	FT	V	
22	99	PAHZZ	PAOZZ	PAGZZ	PAHZZ		.050	6130-00-365-4477 RECTIFIER 69-712 30554 1A43KAHI 01411	CLB, CLC	EA	1	
22	100	PAHZZ	PAOZZ	PAGZZ	PAHZZ		.050	5910-00-434-1602 CAPACITOR, FIXED 69-728-1 30554 74FOIDA205 06001	CLB, CLC CZM, DGG	EA	1	
22	101	PAHZZ	PAOZZ	PAGZZ	PAHZZ		.050	5910-00-331-9981 CAPACITOR, FIXED 69-728-2 30554 74FOLDA564 06001	CLB, CLC CZM, DGG	EA	1	
22	102	PHAZZ	PAOZZ	PAGZZ	PAHZZ		.050	5910-00-007-5626 CAPACITOR, FIXED 69-717-4 30554	CLB, CZM	EA	1	
22	103	PAHZZ	PAOZZ	PAGZZ	PAHZZ		.050	5910-00-331-9999 CAPACITOR, FIXED 69-728-6 30554 74FOLDA103 06001	CLC, DGG	EA	1	
22	104	XAHZZ	XA	XBGZZ	XBHZZ			PW BOARD 69-732-1 30554	CLB, CZM	EA	1	
22	104	XAHZZ	XA	XBGZZ	XBHZZ			PW BOARD 69-732-2 30554	CLB, DGG	EA	1	
22		PAHZZ	PAOZZ	PAGZZ	PAHZZ		.050	5910-00-331-9989 CAPACITOR, FIXED 69-728-3 30554 74FOLDA474 06001	CLB, CLC CZM, DGG	EA	1	
22		PAHZZ	PAOZZ	PAGZZ	PAHZZ		.050	5910-00-331-9990 CAPACITOR, FIXED 69-728-S 30554 74FOLDA474 06001	CLB, CLC CZM, DGG	EA	1	

(1) ILLUSTRATION		(2) SMR CODE				(3)		(4) NATIONAL STOCK NUMBER	(5) DESCRIPTION	(6) USABLE ON CODE	U/M	(7) QTY INC IN UNITS	(8) USMC QTY PER EQUIP
A FIG. NO.	B ITEM NO.	A ARMY	B AIR FORCE	C NAVY	D USMC	A SSI	B REPL FACTOR	REF NUMBER & MFR CODE					
22		PAHZZ	PAOZZ	PAGZZ	PAHZZ		.050	5910-00-083-5049	CAPACITOR, FIXED 69-728-4 30554 74FOLD224 01002	CLB, CLC CZM, DGG	EA	1	
22		PAHZZ	PAOZZ	PAGZZ	PAHZZ		.050	5910-00-166-9158	CAPACITOR, FIXED 69-728-7 30554 74FOLD104 06001	CLB, CLC CZM, DGG	EA	1	
22		MHHHZ	AOO	AGGGG	APFZZ				WIRING HARNESS 69-731 30554 (SAME AS WIRING HARNESS, P/N 69-814(30554), EXCEPT WHERE INDIVIDUAL COMPONENTS ARE ANNOTATED)	CLB, CZM	EA	1	
22		MHHHZ	AFO	AGGGG	APFZZ				WIRING HARNESS 69-814 30554 MANUFACTURE FROM:	CLC, DGG	EA	1	
22	105	XBHZZ	PAOZZ	XNGZZ	PAFZZ	D	.023	5935-00-800-2824	CONNECTOR, RECEPTACLE 69-502-3 30554	CLB, CLC CZM, DGG	EA	1	
22	106	XBHZZ	PAOZZ	XBGZZ	PAFZZ	D	.023	5935-00-813-4722	CONNECTOR, RECEPTACLE 69-502-4 30554	CLB, CLC CZM, DGG	EA	1	
22	107	XBHZZ	PAOZZ	XBGZZ	PAFZZ	D	.023	5935-00-721-0496	CONNECTOR, RECEPTACLE 69-502-5 30554	CLB, CLC CZM, DGG	EA	1	
22	108	XBHZZ	PAOZZ	PAGZZ	PAFZZ	D	.023	5935-00-827-9045	CONNECTOR, RECEPTACLE 69-502-6 30554	CLB, CLC CZM, DGG	EA	1	
22	109	PAHZZ	PAOZZ	PAGZZ	PAFZZ	D	.050	5940-00-813-0698	TERMINAL, LUG MS25036-101 96906	CLB, CZM	EA	2	
22	110	PAHZZ	PAOZZ	XBGZZ	PAFZZ	D	.080	6145-00-643-0647	WIRE, ELECTRICAL M168787-2-20-9 81349	CLB, CLC CZM, DGG	FT	V	
22	111	XBHZZ	PAOZZ	XBGZZ	PAFZZ			5970-00-408-0410	INSULATION, SLEEVING M1123053-CLASS1 81349	CLB, CLC CZM, DGG	FT	V	
22	112	PAHZZ	PAOZZ	PAGZZ	PAFZZ	D	.008	5975-00-074-2072	STRAP, CABLE MS3367-1-9 96906	CLB, CLC CZM, DGG	EA	V	

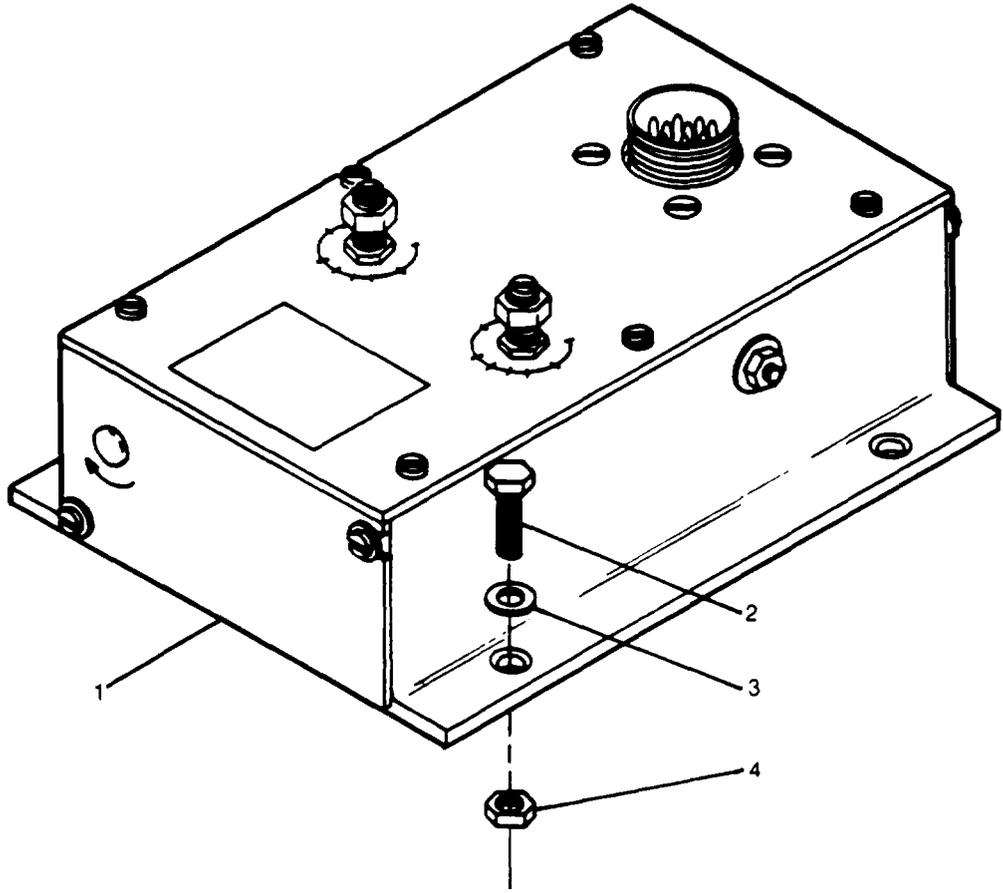

Figure 23. Electric Governor Control Unit.

TM9-6115-465-24P
 TO 35C2-3-446-4
 NAVFAC P-8-625-24P
 SL-4-06858B/06859D

(1) ILLUSTRATION		(2) SMR CODE			(3)		(4) NATIONAL STOCK NUMBER	(5) DESCRIPTION	(6) USABLE ON CODE	(7) QTY INC IN UNITS	(8) USMC QTY PER EQUIP
A FIG. NO.	B ITEM NO.	A ARMY	B AIR FORCE	C NAVY	D USMC	A SSI	B REPL FACTOR	REF NUMBER & MFR CODE	U/M		
23	1	PAFZZ			MFFD			GOVERNOR CONTROL UNIT 81-4903 30554	CLC	EA	1 1
23	2	PAFZZ			PAFZZ			5305-00-225-3839 SCREW HEX HD MS70725-8 96906	CLC	EA	4 4
23	3	PAFZZ			PAFZZ			5310-00-582-5965 WASHER LOCK MS35338-44 96906	CLC	EA	4 4
23	4	PAFZZ			PAFZZ			5310-00-997-1888 NUT PLAIN MS35649-2252 96906	CLC	EA	4 4

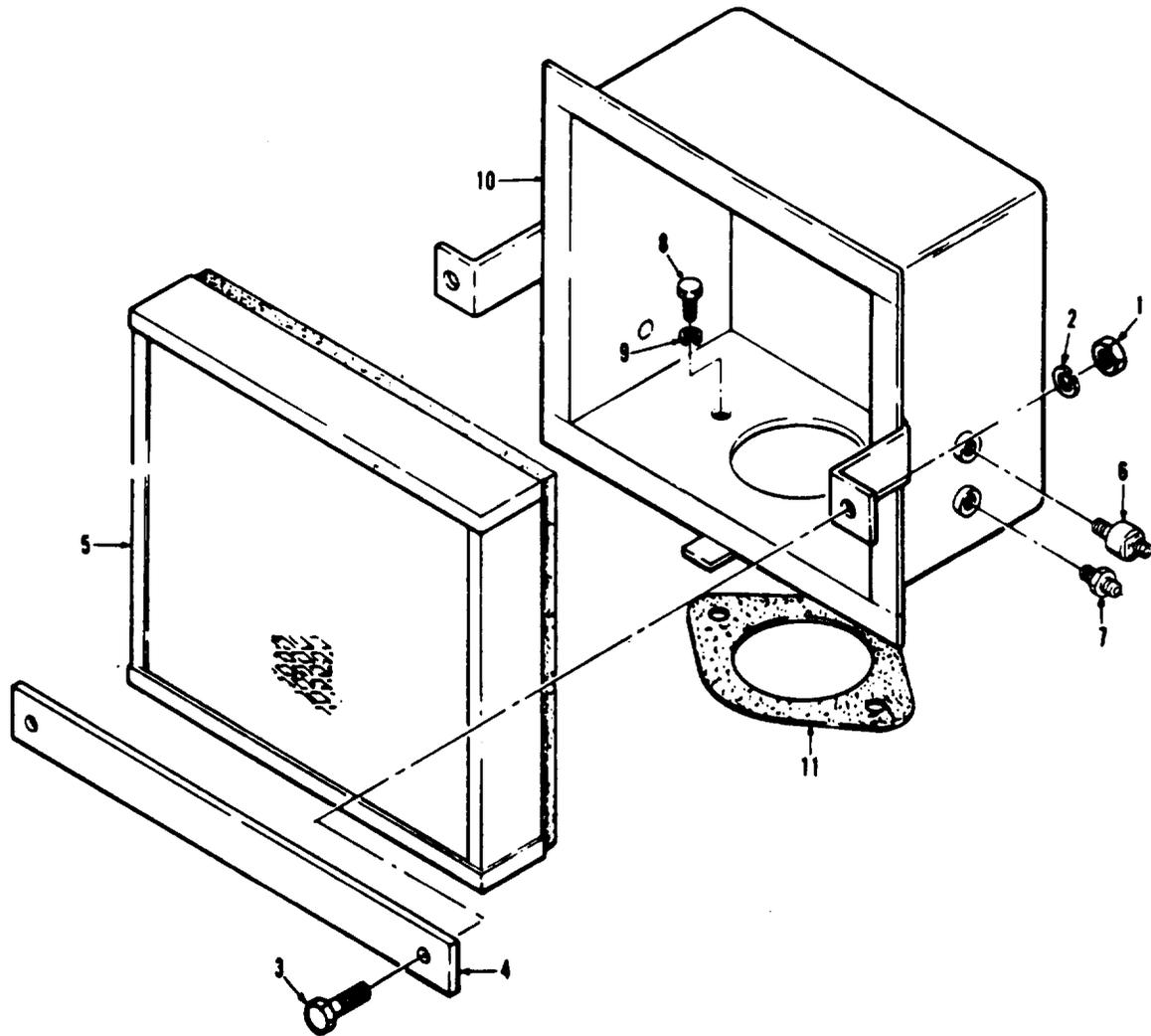

Figure 24. Air cleaner.

TM9-6115-465-24P
 TO 35C2-3-446-4
 NAVFAC P-8-625-24P
 SL-4-06858B/06859D

(1) ILLUSTRATION		(2) SMR CODE				(3)		(4) NATIONAL STOCK NUMBER	(5) DESCRIPTION	(6) USABLE ON CODE	(7) QTY INC IN UNITS	(8) USMC QTY PER EQUIP
A FIG. NO.	B ITEM NO.	A ARMY	B AIR FORCE	C NAVY	D USMC	A SSI	B REPL FACTOR	REF NUMBER & MFR CODE	U/M			
GROUP 12-AIR CLEANER ASSEMBLY												
24	1	PAOZZ	PAOZZ	PAGZZ	PAOZZ	D	.008	5310-00-761-6882 NUT,PLAIN,HEXAGON:RETAINER MTG MS51967-2 96906	EA	2	109	
24	2	PAOZZ	PAOZZ	PAGZZ	PAOZZ	D	.010	5310-00-582-5965 WASHER,LOCK:RETAINER MTG MS35338-44 96906	EA	2	256	
24	3	PAOZZ	PAOZZ	PAGZZ	PAOZZ	D	.008	5305-00-068-0500 SCREW,CAP,HEXAGON HEAD:RETAINER MTG MS90725-3 96906	EA	2	179	
24	4	XBOZZ	MFO	XBGZZ	XBOZZ			RETAINER,FILTER ELEMENT 72-2091 30554 30554-72-2091 36024	EA	1	1	
24	5	PAOZZ	PAOZZ	PAOZZ	PAOZZ		.200	2940-00-463-1362 FILTER ELEMENT:AIR 70-1251 30554 P13-1919 18265	EA	1	1	
24	6	PAOZZ	PAOZZ	PAHZZ	PAOZZ		.040	5930-00-430-3532 SWITCH,PRESSURE:AIR CLEANER 70-1310 30554	EA	1	1	
24	7	PAOZZ	PAOZZ	PAGZZ	PAOZZ		.050	2910-00-615-8587 EITHER INJECTOR 72-2060 30554	EA	1	1	
24	8	PAOZZ	PAOZZ	PAGZZ	PAOZZ	D	.008	5305-00-732-0512 SCREW,CAP,HEXAGON HEAD HOUSING MTG MS90728-107 96906	EA	2	2	
24	9	PAOZZ	PAOZZ	PAGZZ	PAOZZ	D	.010	5310-00-584-5272 WASHER,LOCK:HOUSING MTG MS35338-48 96906	EA	2	256	
24	10	XBOZZ	XB	XBGZZ	XBOZZ			HOUSING,FILTER 72-2019-2 30554 30554-72-2019-2 36024	EA	1	1	
24	11	PAOZZ	PAOZZ	PAHZZ	PAOZZ		.040	5330-01-012-3062 GASKET,AIR INTAKE 72-2117 30554 30554-72-2117 36024	EA	1	1	

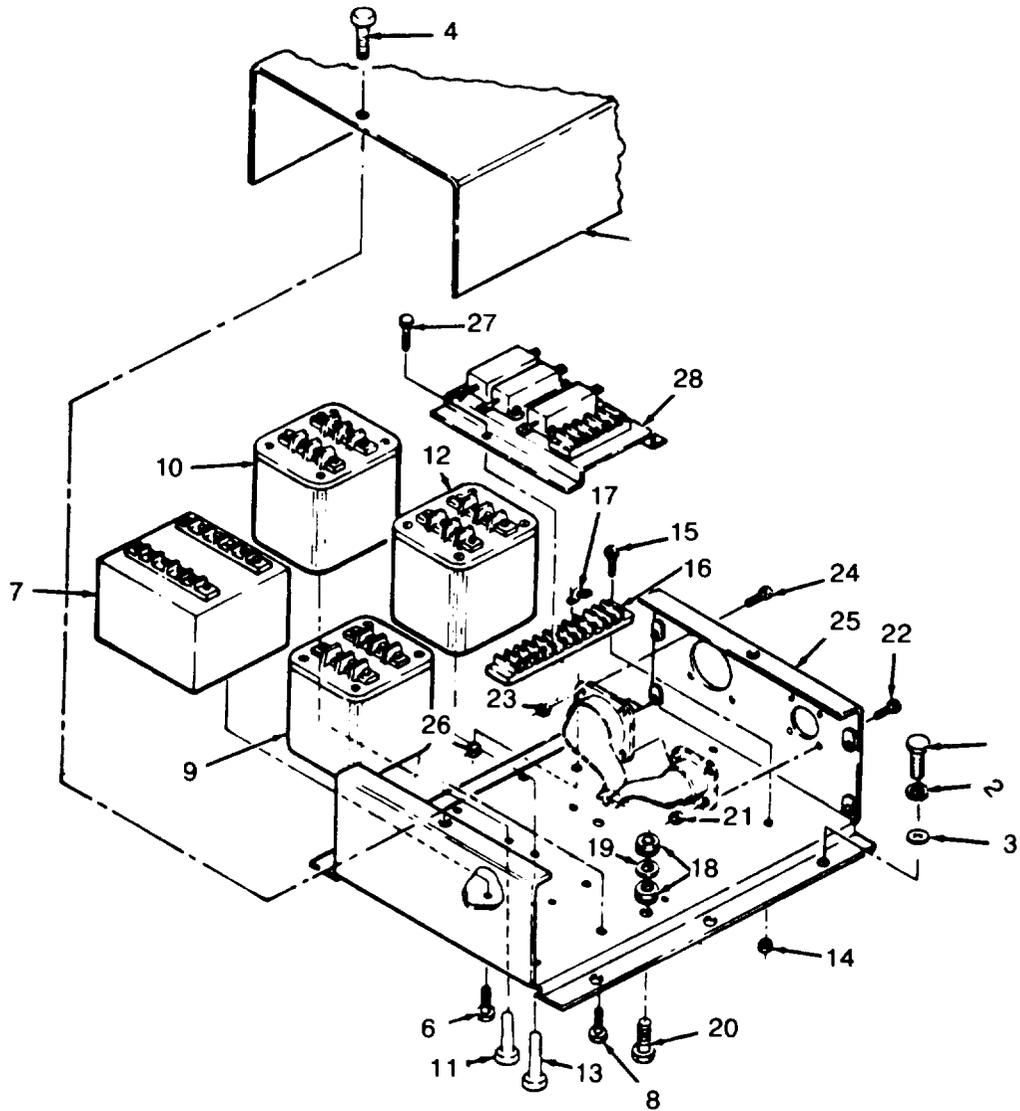

Figure 25. Tactical relay. (sheet 1 of 3)

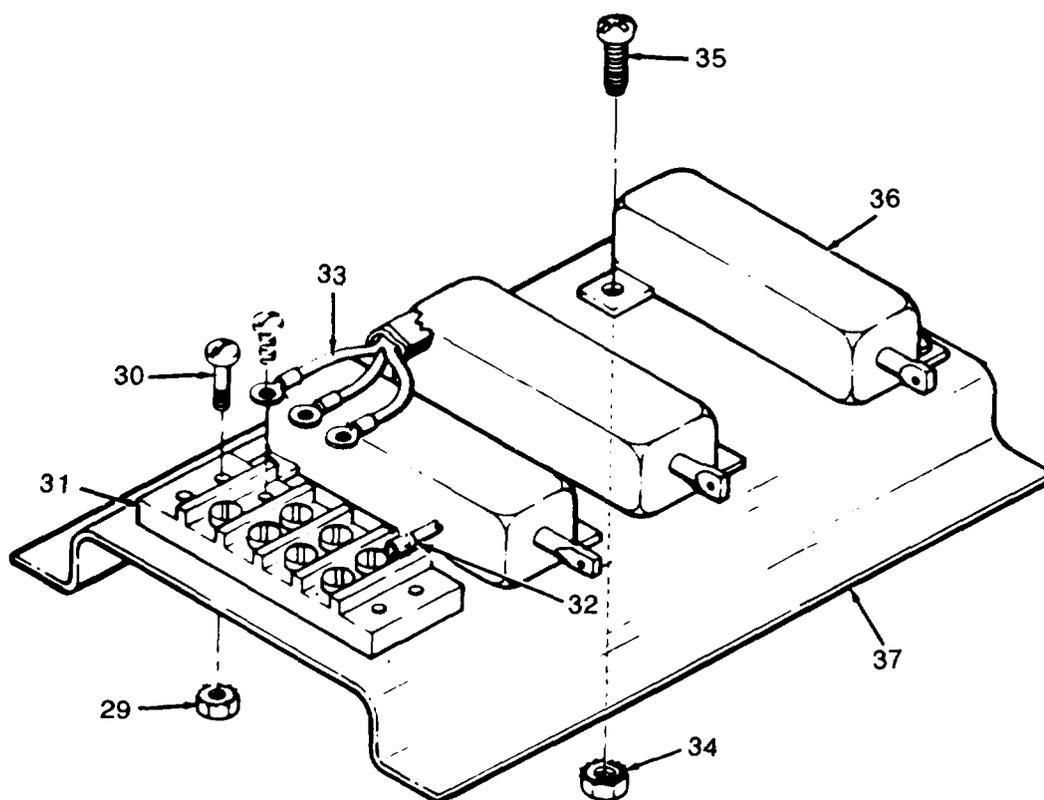

Figure 25. Tactical relay. (sheet 2 of 3)

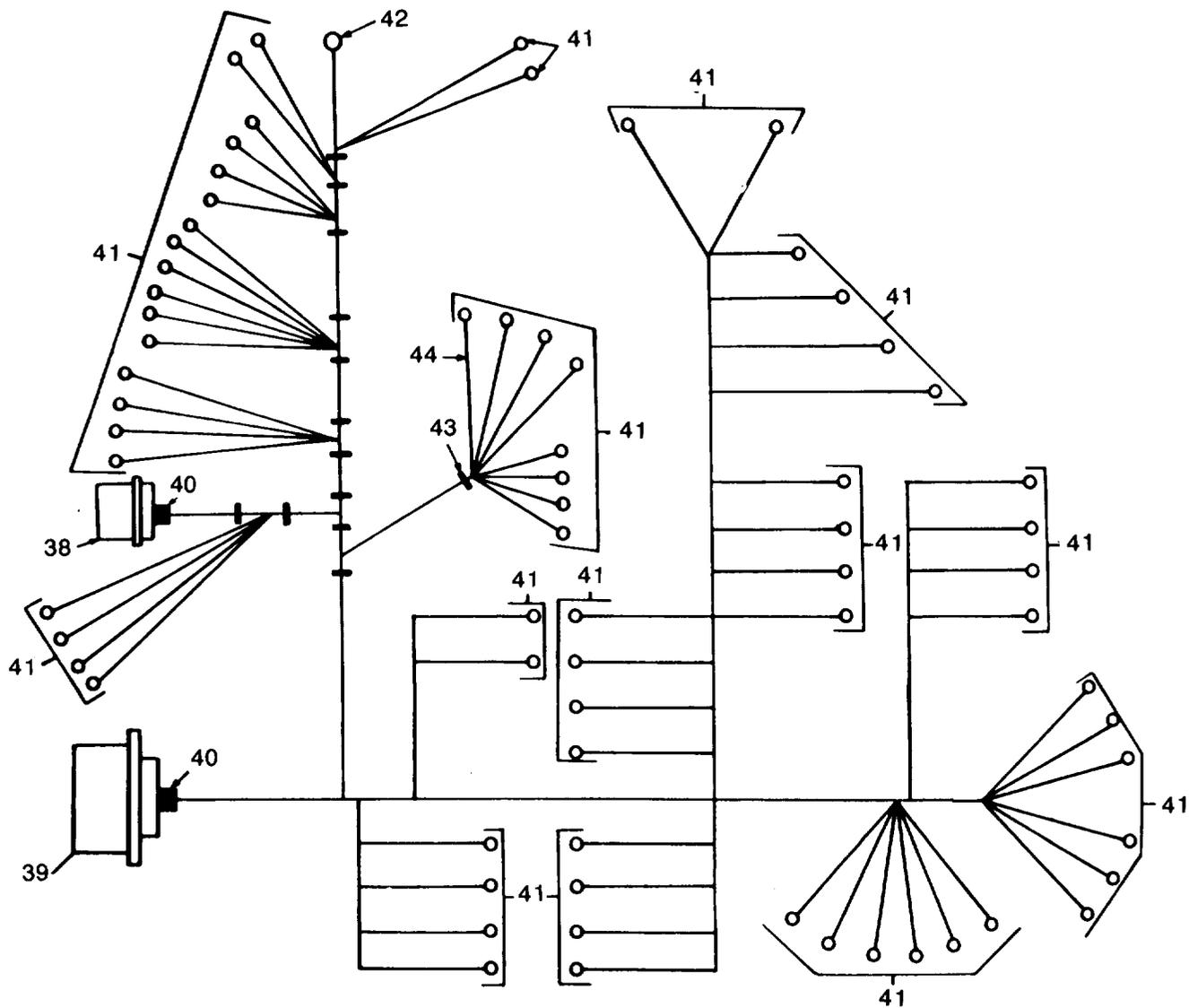

Figure 25. Tactical relay. (sheet 3 of 3)

(1) ILLUSTRATION A FIG. NO.	(2) SMR CODE B ITEM NO.	(3) A ARMY	(3) B AIR FORCE	(3) C NAVY	(3) D USMC	(3) E SSI	(4) NATIONAL STOCK NUMBER	(5) DESCRIPTION REF NUMBER & MFR CODE	(6) USABLE ON CODE	(7) QTY INC IN UNITS	(8) USMC QTY PER EQUIP
GROUP 13-RELAY TABLE GROUP											
25	1	PAFZZ	PAOZZ	PAGZZ	PAFZZ	D	.008 5305-00-068-0500	SCREW,CAP,HEXAGON HEAD:RELAY MTG MS90725-3 96906	EA	6	179
25	2	PAFZZ	PAOZZ	PAGZZ	PAFZZ	D	.010 5310-00-582-5965	WASHER,LOCK:RELAY MTG MS35338-44 96906	EA	6	256
25	3	PAFZZ	PAOZZ	PAGZZ	PAFZZ	D	.010 5310-00-823-8804	WASHER,FLAT:RELAY MTG MS27183-9 96906	EA	6	45
25		PBFFH	PBOPD	PAGGG	PAFFF		.700 6115-00-564-0067	RELAY ASSEMBLY,TACTICAL 72-2209 30554 70-1132 36024	EA	1	1
25	4	PAFZZ	PAOZZ	PAGZZ	PAFZZ	D	.008 5305-00-191-6226	SCREW,WASHER 69-662-64 30554 P15121-64 45722	EA	2	42
25		XBFZZ	MFO	XBGZZ	XBFZZ			COVER,BOX 72-2210 30554 30554-72-2210 36024	EA	1	1
25	6	PAFZZ	PAOZZ	PAOZZ	PAFZZ	D	.008 5305-00-191-6226	SCREW,WASHER:RELAY MTG 69-662-64 30554 P15121-64 45722	EA	2	42
25	7	PAFZZ	PAOZZ	PAGZZ	PAFZZ		.050 5945-00-318-3050	RELAY,OVERLOAD 70-1135 30554	EA	1	1
25	8	PAFZZ	PAOZZ	PAGZZ	PAFZZ	D	.008 5305-00-036-6977	SCREW,WASHER 69-662-33 30554 P15121-33 45722	EA	4	16
25	9	PAFZZ	PAOZZ	PAGZZ	PAFZZ		.050 5945-00-919-7749	RELAY,REVERSE POWER 70-1136 30554 11470 12670	EA	1	1
25	10	PAFZZ	PAOZZ	PAGZZ	PAFZZ		.050 5945-00-420-4561	RELAY,SHORT CIRCUIT 70-1137 30554 21381C1 12670	EA	1	1
25	11	PAFZZ	PAOZZ	PAGZZ	PAGZZ	D	.008 5305-00-036-6977	SCREW,WASHER:RELAY MTG 69-662-33 30554 P15121-33 45722	EA	4	16
25	12	PAFZZ	PAOZZ	PAGZZ	PAFZZ		.050 5945-00-057-5655	RELAY,OVERVOLTAGE 70-1138 30554 11486 12670	EA	1	1
25	13	PAFZZ	PAOZZ	PAGZZ	PAFZZ	D	.008 5305-00-036-6977	SCREW,WASHER:RELAY MTG 69-662-33 30554 P15121-33 45722	EA	1	16
25	14	PAFZZ	PAOZZ	PAGZZ	PAFZZ	D	.008 5310-00-063-7360	NUT,WASHER 69-581-2 30554 511-061800-00 78189	EA	2	51
25	15	PAFZZ	PAOZZ	PAGZZ	PAFZZ	D	.008 5305-00-889-3001	SCREW,MACHINE MS35206-231 96906	EA	2	12
25	16	XBFZZ	XB	XBGZZ	XBFZZ		5940-00-TERMINAL BOARD	37TB10 81349	EA	1	1
25	17	XBFZZ	XB	XBGZZ	XBFZZ		5940-00-632-7234	LINK,TERMINAL CONNECTION 69-651-1 30554 600U 75382	EA	2	2
25	18	PAFZZ	PAOZZ	PAGZZ	PAFZZ	D	-.008 5310-00-052-3632	NUT,WASHER:GROUND 69-561-3 30554 511-081800-00 78189	EA	2	54

(1) ILLUSTRATION A FIG. NO.	(2) SMR CODE B ITEM NO.	A	B	C	D	(3) A SSI	B REPL FACTOR	(4) NATIONAL STOCK NUMBER	(5) DESCRIPTION REF NUMBER & MFR CODE	USABLE ON CODE	(6) U/M	(7) QTY INC IN UNITS	(8) USMC QTY PER EQUIP
25	19	PAFZZ	PAOZZ	PAGZZ	PAFZZ	D	.010	5310-00-809-8544	WASHER, PLAT MS28183-7 96906	EA	1	21	
25	20	PAFZZ	PAOZZ	PAGZZ	PAFZZ	D	.008	5305-00-984-6193	SCREW, MACHINE MS36206-245 96906	EA	1	17	
25	21	PAFZZ	PAOZZ	PAGZZ	PAFZZ	D	.008	5310-00-934-9747	NUT, PLAIN, HEXAGON MS35649-262 96906	EA	4	36	
25	22	PAFZZ	PAOZZ	PAGZZ	PAFZZ	D	.008	5305-00-036-0968	SCREW, WASHER 69-662-18 30554 P15121-18 45722	EA	4	46	
25	23	PAFZZ	PAOZZ	PAGZZ	PAFZZ	D	.008	5310-00-934-9748	NUT, PLAIN, HEXAGON MS35649-242 96906	EA	4	39	
25	24	PAFZZ	PAOZZ	PAGZZ	PAFZZ	D	.008	5305-00-038-3089	SCREW, WASHER: WIRING HARNESS MTG 69-662-3 30554 P15121-3 45722	EA	4	32	
25	25	XBFZZ	XB	XBGZZ	XBFZZ				CHASIS, BOX 72-2211 30554 30554-72-2211 36024	EA	1	1	
25	26	PAFZZ	PAOZZ	PAGZZ	PAFZZ	D	.008	5310-00-063-7360	NUT, WASHER: RESISTOR MTG 69-561-2 30554 511-061800-00 78139	EA	2	51	
25	27	PAFZZ	PAOZZ	PAGZZ	PAFZZ	D	.008	5305-00-984-6191	SCREW, MACHINE: RESISTOR MTG MS35206-243 96906	EA	2	21	
25	28	PAFZZ	AO	AGGGG	AFFZZ				RESISTOR ASSEMBLY 72-2226 30554 30554-72-2226 36024	EA	1	1	
25	29	PAFZZ	PAOZZ	PAGZZ	PAFZZ	D	.008	5310-00-063-7360	NUT, WASHER 69-561-2 30554 511-06800-00 78189	EA	2	51	
25	30	PAFZZ	PAOZZ	PAGZZ	PAFZZ	D	.008	5305-00-889-3001	SCREW, MACHINE MS35206-231 96906	EA	2	12	
25	31	XBFZZ	XB	XBGZZ	PAFZZ			5940-00-983-6045	TERMINAL BOARD 37TB4 81349	EA	1	1	
25	32	PAFZZ	PAOZZ	PAGZZ	PAFZZ	D	.050	5940-00-204-8966	TERMINAL, LUG MS25036-102 96906	EA	4	381	
25	33	PAFZZ	PAOZZ	PAGZZ	PAFZZ	D	.080	6145-00-578-6602	WIRE, ELECTRICAL M5086-2-18-9 81349	FT	V	232	
25	34	PAFZZ	PAOZZ	PAGZZ	PAFZZ	D	.008	5310-00-063-7415	NUT, WASHER: RESISTOR MTG 69-561-1 30554 511-041800-00 78189	EA	6	18	
25	35	PAFZZ	PAOZZ	PAGZZ	PAFZZ	D	.008	5305-00-889-2997	SCREW, MACHINE: RESISTOR MTG MS36206-215 96906	EA	6	6	
25	36	PAFZZ	PAOZZ	PAGZZ	PAFZZ	D	.040	5905-00-459-2558	RESISTOR, FIXED RER75F7R50R 81349	EA	3	3	
25	37	XBFZZ	XB	XBGZZ	XBFZZ				BRACKET, RESISTOR 72-2227 30554 30554-72-2227 36024	EA	1	1	
25		MFFFF	MOO	AGGGG	AFFZZ				WIRING HARNESS 72-2243 30554 30554-72-2243 36024 MANUFACTURE FROM:	EA	1	1	

TM9-6115-465-24P
 TO 35C2-3-446-4
 NAVFAC P-8-625-24P
 SL-4-06858B/06859D

(1) ILLUSTRATION		(2) SMR CODE				(3)		(4) NATIONAL STOCK NUMBER	(5) DESCRIPTION	(6) USABLE ON CODE	(7) QTY INC IN UNITS	(8) USMC QTY PER EQUIP
A FIG. NO.	B ITEM NO.	A ARMY	B AIR FORCE	C NAVY	D USMC	A SSI	B REPL FACTOR	REF NUMBER & MFR CODE	U/M			
25	38	PAFZZ	PAOZZ	PAGZZ	PAFZZ	D	.030	5935-00-765-2787 CONNECTOR, RECEPTACLE MS3102R20-29P 96906	EA	1	1	
25	39	PAFZZ	PAOZZ	PAGZZ	PAFZZ	D	.030	5935-00-725-0888 CONNECTOR, RECEPTACLE MS3102R28-12P 96906	EA	1	3	
25	40	PAFZZ	PAOZZ	XBGZZ	PAFZZ	D	.008	5970-00-954-1622 INSULATION, SLEEVING M23053-5-105-0 81349	FT	V	V	
25	41	PAFZZ	PAOZZ	PAGZZ	PAFZZ	D	.050	5940-00-204-8966 TERMINAL, LUG MS25036-102 96906	EA	71	232	
25	42	PAFZZ	PAOZZ	PAGZZ	PAFZZ	D	.050	5940-00-557-1629 TERMINAL, LUG MS25036-149 96906	EA	1	33	
25	43	PAFZZ	PAOZZ	PAGZZ	PAFZZ	D	.008	5975-00-111-3208 STRAP, CABLE MS3367-5-9 96906	EA	40	232	
25	44	PAFZZ	PAOZZ	PAGZZ	PAFZZ	D	.080	6145-00-578-6602 WIRE, ELECTRICAL M5086-2-18-9 81349	FT	42	232	

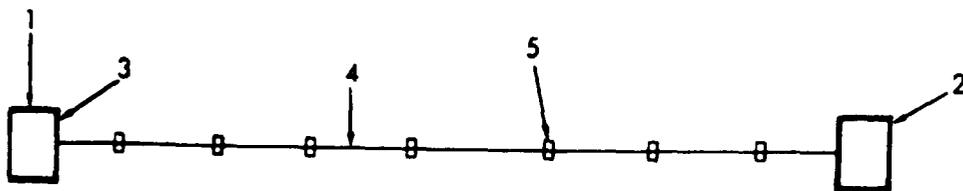

Figure 26. Tactical relay to special relay wiring harness.

TM9-6115-465-24P
 TO 35C2-3-446-4
 NAVFAC P-8-625-24P
 SL-4-06858B/06859D

(1) ILLUSTRATION		(2) SMR CODE				(3)		(4) NATIONAL STOCK NUMBER	(5) DESCRIPTION	(6) USABLE ON CODE	(7) QTY INC IN UNITS	(8) USMC QTY PER EQUIP
A FIG. NO.	B ITEM NO.	A ARMY	B AIR FORCE	C NAVY	D USMC	A SSI	B REPL FACTOR	REF NUMBER & MFR CODE	U/M			
26		MFOFF	AOO	AGGGG	AFFZZ			WIRING HARNESS 72-2224 30554 30554-72-2224 36024 MANUFACTURE FROM:	EA	1	1	
26	1	PAFZZ	PAOZZ	PAGZZ	PAFZZ	D	.023	5935-00-725-7248 CONNECTOR, PLUG MS310R28-12S 96906	EA	1	1	
26	2	PAFZZ	PAOZZ	PAGZZ	PAFZZ	D	.023	5935-00-752-2793 CONNECTOR, PLUG MS3106R28-12P 96906	EA	1	1	
26	3	XBFZZ	PAOZZ	PAGZZ	PAFZZ	D	.008	5935-00-823-5322 SEAL, PLUG MS25251-16 96906	EA	2	54	
26	4	PAFZZ	PAOZZ	PAGZZ	PAFZZ	D	.008	6145-00-578-6605 WIRE, ELECTRICAL M5086-2-16-9 81349	FT	56	490	
26	5	PAFZZ	PAOZZ	PAGZZ	PAFZZ	D	.008	5975-00-111-3208 STRAP, CABLE MS3367-5-9 96906	EA	8	232	

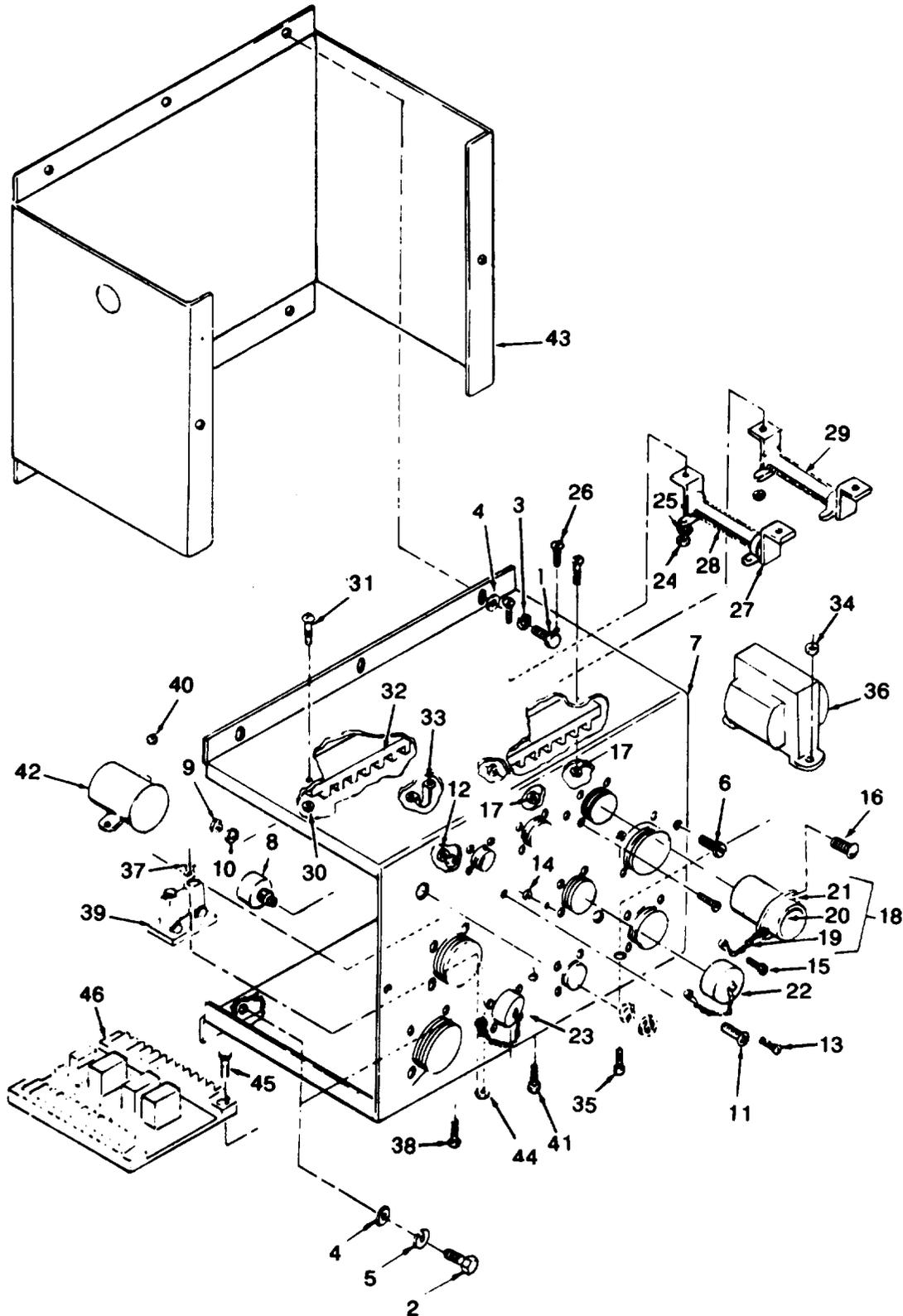

Figure 27. Special relay. (sheet 1 of 3)

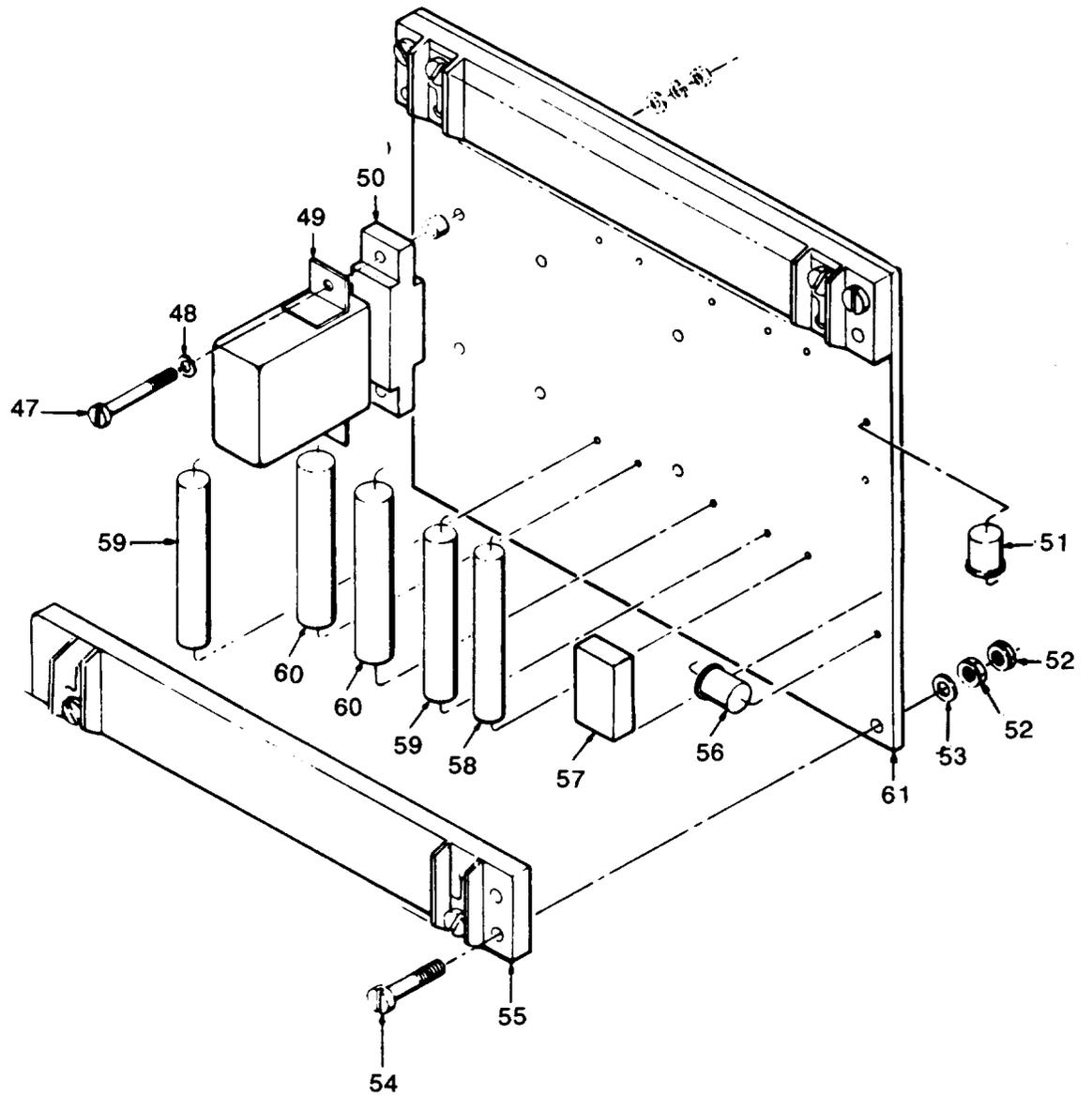

Figure 27. Special relay. (sheet 2 of 3)

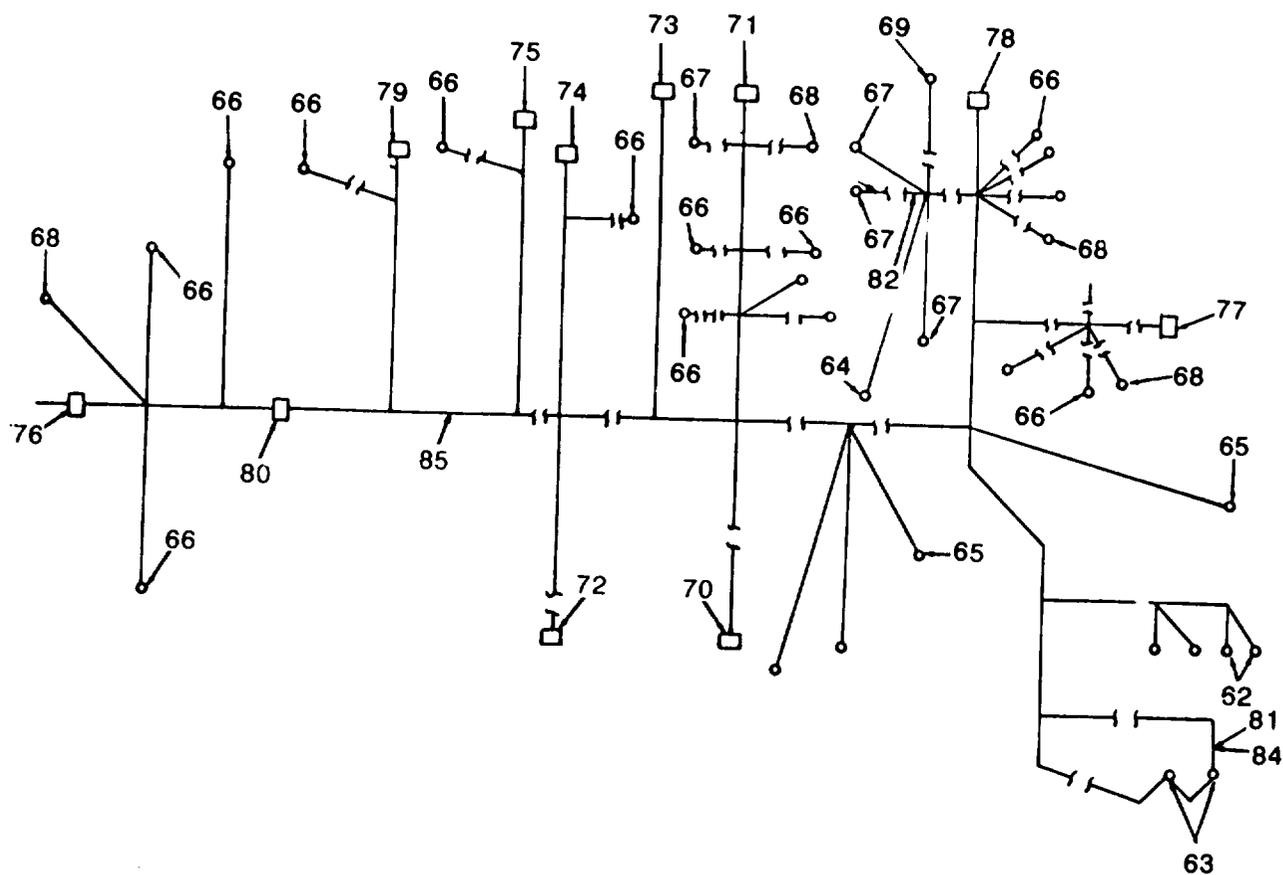

Figure 27, Special relay. (sheet 3 of 3)

(1) ILLUSTRATION A FIG. NO.	(2) SMR CODE B ITEM NO.	(3) A ARMY	(3) B AIR FORCE	(3) C NAVY	(3) D USMC	(3) A SSI	(4) NATIONAL STOCK NUMBER	(5) DESCRIPTION REF NUMBER & MFR CODE	(6) USABLE ON CODE U/M	(7) QTY INC IN UNITS	(8) USMC QTY PER EQUIP
27	1	PAFZZ	PAOZZ	PAGZZ	PAFZZ	D	.008 5305-00-068-0500	SCREW,CAP MS90725-3 96906	CLA,CLB CLC,DGG	EA	6 179
27	2	PAFZZ	PAOZZ		PAFZZ	D	.008 5305-00-068-0502	SCREW,CAP,HEXAGON HEAD MS90725-6 96906	CZM,CZN	EA	3 73
27	3	PAFZZ	PAOZZ	PAGZZ	PAFZZ	D	.010 5310-00-582-5965	WASHER,LOCK:RELAY ASSEMBLY MTG MS35338-44 96906		EA	6 256
27	4	PAFZZ	PAOZZ	PAGZZ	PAFZZ	D	.010 5310-00-823-8804	WASHER,FLAT:RELAY ASSEMBLY MTG MS27183-9 96906		EA	6 45
27	5	PAFZZ	PAOZZ		PAFZZ	D	.010 5310-00-067-6357	WASHER,LOCK MS45904-69 96906	CZN,CZM	EA	6 50
27		PBFHH	PBOFF	PAGGG	PAFZZ		.700 6115-00-564-0074	RELAY ASSEMBLY:SPECIAL 72-2232 30554 30554-72-2232 36024		EA	1 1
27	6	PAFZZ	PAOZZ	PAGZZ	PAFZZ	D	.008 5305-00-191-6226	SCREW,WASHER 69-662-64 30554 P15121-64 45722		EA	2 42
27	7	XBFZZ	XA	XBGZZ	XBFZZ			COVER,RELAY BOX 72-2233 30554 30554-72-2233 36024		EA	1 1
27	8	PAFZZ	PAOZZ	PAGZZ	PAFZZ		.036 5905-01-021-9133	RESISTOR,VARIABLE 75-0851 30554 RP0025-2120GBA 24681		EA	1 1
27	9	PAFZZ	PAOZZ	PAGZZ	PAFZZ	D	.008 5310-00-052-3632	NUT,WASHER 69-561-3 30554 511-061800-00 78189		EA	4 54
27	10	PAFZZ	PAOZZ	PAGZZ	PAFZZ	D	.010 5310-00-809-8544	WASHER,FLAT MS27183-7 96906		EA	2 17
27	11	PAFZZ	PAOZZ	PAGZZ	PAFZZ	D	.008 5305-00-984-6193	SCREW,MACHINE:GROUND MS35206-245 96906		EA	2 17
27	12	PAFZZ	PAOZZ	PAGZZ	PAFZZ	D	.008 5310-00-934-9739	NUT,PLAIN,HEXAGON MS35649-242 96906		EA	4 39
27	13	PAFZZ	PAOZZ	PAGZZ	PAFZZ	D	.008 5305-00-038-3089	SCREW,WASHER 69-662-3 30554 P15121-3 45722		EA	1 32
27	14	PAFZZ	PAOZZ	PAGZZ	PAFZZ	D	.008 5310-00-934-9739	NUT,PLAIN,HEXAGON MS35649-242 96906		EA	1 39
27	15	PAFZZ	PAOZZ	PAGZZ	PAFZZ	D	.008 5305-00-038-3089	SCREW,WASHER 69-662-3 30554 P15121-3 45722		EA	1 32
27	16	PAFZZ	PAOZZ	PAGZZ	PAFZZ	D	.008 5305-00-036-6968	SCREW,WASHER 69-662-18 30554 P15121-18 45772		EA	4 67
27	17	PAFZZ	PAOZZ	PAGZZ	PAFZZ	D	.008 5310-00-934-9747	NUT,HEXAGON MS35649-262 96906		EA	4 76
27	18	MFFZZ	PAOZZ	MFFZZ	MFFZZ	D	.023	PLUG,CHAIN ASSEMBLY 72-2241 30554 30554-72-2241 36024 MANUFACTURE FROM:		EA	1 1
27	19	PAFZZ	PAOZZ	PBFZZ	PAFZZ			CHAIN RRC271TYPE2CLASS7B 81348	FT	V	V

(1) ILLUSTRATION A	(2) SMR CODE A	B	C	D	(3)		(4) NATIONAL STOCK NUMBER	(5) DESCRIPTION REF NUMBER & MFR CODE	(6) USABLE ON CODE U/M	(7) QTY INC IN UNITS	(8) USMC QTY PER EQUIP
					A	B					
27	20	PAFZZ	PAOZZ	PAGZZ	PAFZZ		6145-00-578-6605	WIRE,ELECTRICAL QW343TYPES16AWG 81348	FT	V	V
27	21	PAFZZ	PAOZZ	PAGZZ	PAFZZ		5935-00-845-1349	CONNECTOR,PLUG MS3106R24-28P 96906	EA	1	1
27	22	XBFZZ	PAOZZ	XBGZZ	PAFZZ	D	.005 5935-00-137-4670	COVER,CONNECTOR MS25043-22D 96906	EA	1	1
27	23	XBFZZ	PAOZZ	XBGZZ	PAFZZ	D	.008 5935-00-500-5008	COVER,CONNECTOR MS25043-18D 96906	EA	1	4
27	24	PAFZZ	PAOZZ	PAGZZ	PAFZZ	D	.008 5310-00-934-9747	NUT,PLAIN,HEXAGON:BRACKET ASSEMBLY MS35649-262 96906	EA	2	39
27	25	PAFZZ	PAOZZ		PAFZZ	D	.010 5310-00-082-1404	WASHER,FLAT:BRACKET MTG MS27183-6 96906	CZN,CZM EA	2	18
27	26	PAFZZ	PAOZZ	PAGZZ	PAFZZ	D	.008 5305-00-036-6968	SCREW,WASHER:BRACKET MTG 69-662-18 30554 P15121-18 45722	EA	2	32
27	27	XBFZZ	PAOZZ	XBGZZ	XBGZZ		5905-00-860-6276	BRACKET,RESISTOR MS75009-33 96906	EA	2	4
27	28	PAFZZ	PAOZZ	PAGZZ	PAFZZ		.040 5905-00-642-1955	RESISTOR,FIXED RW33V100 81349	EA	1	1
27	29	PAFZZ	PAOZZ	PAGZZ	PAFZZ		.040 5905-00-805-8471	RESISTOR,FIXED RW33V300 81349	EA	1	1
27	30	PAFZZ	PAOZZ	PAGZZ	PAFZZ	D	.008 5310-00-063-7360	NUT,WASHER:TERMINAL BOARD MTG 69-561-2 30554 511-061800-00 78189	EA	4	51
27	31	PAFZZ	PAOZZ	PAGZZ	PAFZZ	D	.008 5305-00-889-3001	SCREW,MACHINE:TERMINAL BOARD MTG MS35206-231 96906	EA	4	12
27	32	XBFZZ	XB	XBGZZ	XBFZZ		5940-00-983-6096	TERMINAL BOARD 38TB20 81349	EA	2	2
27	33	XBFZZ	XB	XBGZZ	XBFZZ		5940-00-578-3482	JUMPER,TERMINAL BOARD 69-651-2 30554 601J 75382	EA	6	6
27	34	PAFZZ	PAOZZ	PAGZZ	PAFZZ	D	.006 5310-00-052-3632	NUT,WASHER:TRANSFORMER MTG 69-561-3 30554 511-081800-00 78189	EA	2	54
27	35	PAFZZ	PAOZZ	PAGZZ	PAFZZ	D	.008 5305-00-984-6191	SCREW,MACHINE:TRANSFORMER MTG MS35206-243 96906	EA	2	2
27	36	PAFZZ	PAOZZ	PAGZZ	PAFZZ		.040 5950-00-601-6296	TRANSFORMER 72-2204 30554 30554-72-2204 36024	EA	1	1
27	37	PAFZZ	PAOZZ	PAGZZ	PAFZZ	D	.010 5310-00-809-8544	NUT,WASHER:SHUNT MTG MS27183-7 96906	EA	2	17
27	38	PAFZZ	PAOZZ	PAGZZ	PAFZZ	D	.008 5305-00-984-6194	SCREW,MACHINE:SHUNT MTG MS35206-246 96906	EA	2	6
27	39	PAFZZ	PAOZZ	PAGZZ	PAFZZ	D	.008 6625-00-892-4342	SHUNT,INSTRUMENT MSA200 81349	EA	1	1
27	40	PAFZZ	PAOZZ	PAGZZ	PAFZZ	D	.008 5310-00-052-3632	NUT AND CAPTIVE WASHER:RELAY MTG 69-561-3 30554 511-01800-00 78189	EA	2	109

(1) ILLUSTRATION		(2) SMR CODE				(3)		(4)	(5)	(6)	(7)	(8)
A	B	A	B	C	D	A	B	NATIONAL STOCK NUMBER	DESCRIPTION	USABLE ON CODE	QTY INC IN UNITS	USMC QTY PER EQUIP
FIG. NO.	ITEM NO.	ARMY	AIR FORCE	NAVY	USMC	SSI	REPL FACTOR		REF NUMBER & MFR CODE	U/M		
27	41	PAFZZ	PAOZZ	PAGZZ	PAFZZ	D	.008	5305-00-984-6191	SCREW,CAP,HEXAGON HEAD:RELAY MS35206-24 96906	EA	2	179
27	42	PAFZZ	PAOZZ	PAGZZ			.050	5945-00-686-6877	RELAY,CRANKING MS24166-D1 96906	EA	Q	Q
27	43	XAFZZ	XA	XBGZZ	XBFZZ				CHASIS,RELAY 72-2235 30554 30554-72-2235 36024	EA	1	1
27	44	PAFZZ	PAOZZ	PAGZZ	PAFZZ	D	.008	5310-00-063-7360	NUT,WASHER:RELAY MTG 69-561-2 30554 5111-061800-00 78189	EA	4	51
27	45	PAFZZ	PAOZZ	PAGZZ	PAFZZ	D	.008	5305-00-038-3089	SCREW,WASHER:RELAY MTG 69-662-3 30554 F15121-3 45722	EA	4	32
27	46	PAFZZ	AOO	PAHHH	PAFFF		.800	6110-00-201-6015	RELAY,ASSEMBLY:DC 69-768 30554 30554-69-768 36024	EA	1	1
27	47	PAFZZ	PAOZZ	PAGZZ	PAFZZ	D	.008	5305-00-984-4982	SCREW,MACHINE:RELAY MTG MS35206-225 96906	EA	6	12
27	48	PAFZZ	PAOZZ	PAGZZ	PAFZZ	D	.010	5310-00-045-4007	WASHER,LOCK:RELAY MTG MS35338-41 96906	EA	8	41
27	49	PAFZZ	PAOZZ	PAHZZ	PAFZZ		.050	5945-00-435-1833	RELAY M5757-23-003 81349	EA	3	6
27	50	XBFZZ	XB	XBGZZ	PAFZZ		.050	5935-00-206-1400	SOCKET,RELAY 69-658 30554 VB8-1FALL-80 05574	EA	3	5
27	51	PAFZZ	PAOZZ	PAGZZ	PAFZZ		.050	5961-00-042-8637	RECTIFIER 69-741 30554 JANTXIN5616 81349	EA	1	1
27	52	PAFZZ	PAOZZ	PAGZZ	PAFZZ	D	.008	5310-00-063-7360	NUT,WASHER:TERMINAL BOARD MTG 69-561-2 30554 511-061800-00 78189	EA	8	51
27	53	PAFZZ	PAOZZ	PAGZZ	PAFZZ	D	.010	5310-00-983-8483	WASHER,PLAT:TERMINAL BOARD MTG MS27183-5 96906	EA	4	4
27	54	XBFZZ	XB	XBGZZ	PAFZZ	D	.008	5305-00-984-6221	SCREW,MACHINE:TERMINAL BOARD MTG M35206-234 96906	EA	4	4
27	55	XBFZZ	XB	XBGZZ	PAFZZ			5940-00-983-6093	TERMINAL BOARD 40TB12 81349	EA	2	2
27	56	PAFZZ	PAOZZ	PAGZZ	PAFZZ		.050	5981-00-702-5763	RECTIFIER 69-740 30554 IN4722 80131	EA	2	2
27	57	PAFZZ	PAOZZ	PAGZZ	PAFZZ		.040	5961-00-135-6168	RECTIFIER 69-739 30554 B598-40 06288	EA	1	2
27	58	PAFZZ	PAOZZ	PAGZZ	PAFZZ		.040	5905-00-357-3093	RESISTOR,FIXED RWR78S1501FR 81349	EA	1	1
27	59	PAFZZ	PAOZZ	PAGZZ	PAFZZ		.040	5905-00-448-5539	RESISTOR,FIXED RWR78S2671FR 81349	EA	2	2
27	60	PAFZZ	PAOZZ	PAGZZ	PAFZZ		.040	5905-00-879-1163	RESISTOR,FIXED RW56V512 81349	EA	2	2

(1) ILLUSTRATION		(2) SMR CODE				(3)		(4)	(5)	(6)	(7)	(8)
A	B	A	B	C	D	A	B	NATIONAL STOCK NUMBER	DESCRIPTION	USABLE ON CODE	QTY INC IN UNITS	USMC QTY PER EQUIP
FIG. NO.	ITEM NO.	ARMY	AIR FORCE	NAVY	USMC	SSI	REPL FACTOR		REF NUMBER & MFR CODE	U/M		
27	61	XAFZZ	XB	XBFZZ	XBFZZ				CIRCUIT BOARD 69-767 30554 30554-69-767 36024	EA	1	1
27		MFFFF	PBOZZ	AGGGG	APFZZ			6115-00-610-2116	WIRING HARNESS:SPECIAL RELAY BOX 72-2239 30554 30554-73-2239 36024 MANUFACTURE FROM:	EA	1	1
27	62	PAFZZ	PAOZZ	PAGZZ	PAFZZ	D	.050	5940-00-825-5041	TERMINAL LUG MS17143-6 96906	EA	4	4
27	63	PAFZZ	PAOZZ	PAGZZ	PAFZZ	D	.050	5940-00-283-5280	TERMINAL,LUG MS25036-106 96906	EA	4	46
27	64	PAFZZ	PAOZZ	PAGZZ	PAFZZ	D	.050	5940-00-143-4794	TERMINAL,LUG MS25036-112 96906	EA	2	3
27	65	PAFZZ	PAOZZ	PAGZZ	PAFZZ	D	.050	5940-00-204-8966	TERMINAL,LUG MS25036-102 96906	EA	117	294
27	66	PAFZZ	PAOZZ	PAGZZ	PAFZZ	D	.050	5940-00-557-1629	TERMINAL,LUG MS25036-149 96906	EA	5	26
27	67	PAFZZ	PAOZZ	PAGZZ	PAFZZ	D	.050	5940-00-143-4777	TERMINAL,LUG MS25036-157 96906	EA	4	6
27	68	PAFZZ	PAOZZ	XBGZZ	PAFZZ	D	.050	5340-00-143-4775	TERMINAL,LUG MS25036-156 96906	EA	5	9
27	69	PAFZZ	PAOZZ	XBGZZ	PAFZZ	D	.050	5940-00-143-4780	TERMINAL,LUG MS25036-108 96906	EA	2	6
27	70	PAFZZ	PAOZZ	PAGZZ	PAFZZ	D	.023	5935-00-801-6620	CONNECTOR,RECEPTACLE MS3102R1486S 96906	EA	1	1
27	71	PAFZZ	PAOZZ	PAGZZ	PAFZZ	D	.023	5935-00-842-6316	CONNECTOR,RECEPTACLE MS3102R18-11SC 96906	EA	1	1
27	72	PAFZZ	PAOZZ	PAGZZ	PAFZZ	D	.023	5935-00-801-6621	CONNECTOR,RECEPTACLE MS3102R20-27S 96906	EA	1	1
27	73	PAFZZ	PAOZZ	PAGZZ	PAFZZ	D	.023	5935-00-755-3494	CONNECTOR,RECEPTACLE MS3102R20-29S 96906	EA	1	1
27	74	PAFZZ	PAOZZ	PAGZZ	PAFZZ	D	.023	5935-00-082-0567	CONNECTOR,RECEPTACLE MS3102R22-19S 96906	EA	1	1
27	75	PAFZZ	PAOZZ	PAGZZ	PAFZZ	D	.023	5935-00-721-0501	CONNECTOR,RECEPTACLE MS3102R24-28S 96906	EA	1	1
27	76	PAFZZ	PAOZZ	PAGZZ	PAFZZ	D	.023	5935-00-432-8607	CONNECTOR,RECEPTACLE MS3102R28-12S 96906	EA	1	1
27	77	PAFZZ	PAOZZ	PAGZZ	PAFZZ	D	.023	5935-00-726-8317	CONNECTOR,RECEPTACLE MS3102R32-7P 96906	EA	1	1
27	78	PAFZZ	PAOZZ	PAGZZ	PAFZZ	D	.023	5935-00-844-4467	CONNECTOR,RECEPTACLE 69-661-14 30554	EA	1	1
27	79	PAFZZ	PAOZZ	PAGZZ	PAFZZ	D	.023	5935-00-824-7883	CONNECTOR,RECEPTACLE MS3102R36-7S 96906	EA	1	1
27	80	PAFZZ	PAOZZ	PAGZZ	PAFZZ	D	.008	5875-00-111-3208	STRAP,CABLE MS3367-5-9 96906	EA	V	32
27	81	PAFZZ	PAOZZ		PAFZZ	D	.008	5970-00-954-1622	INSULATION,SLEEVING M23053/5-105-0 30554	CZN,CZM FT	12	1

TM9-6115-465-24P
 TO 35C2-3-446-4
 NAVFAC P-8-625-24P
 SL-4-06858B/06859D

(1) ILLUSTRATION		(2) SMR CODE				(3)		(4) NATIONAL STOCK NUMBER	(5) DESCRIPTION	(6) USABLE ON CODE	(7) QTY INC IN UNITS	(8) USMC QTY PER EQUIP
A FIG. NO.	B ITEM NO.	A ARMY	B AIR FORCE	C NAVY	D USMC	A SSI	B REPL FACTOR	REF NUMBER & MFR CODE	U/M			
27	82	XBFZZ	PAOZZ	XBGZZ	XBFZZ			5970-00-543-1098	INSULATION,TUBING MIL1631TYPEFORMULA 12AWG 81349	FT	12 12	
27	83	PAFZZ	PAOZZ	PAGZZ	PAFZZ	D	.080	6145-00-578-7514	WIRE,ELETRICAL M5086/2-16-9 81349	FT		
27	84	PAFZZ	PAOZZ	PAGZZ	PAFZZ	D	.080	6145-00-578-6605	WIRE,ELECTRICAL M5086/2-16-9 81349	FT	V	
27	85	PAFZZ	PAOZZ	PAGZZ	PAFZZ	D	.080	6145-00-578-6605	WIRE,ELECTRICAL M5086/2-18-9 81349	FT	V	

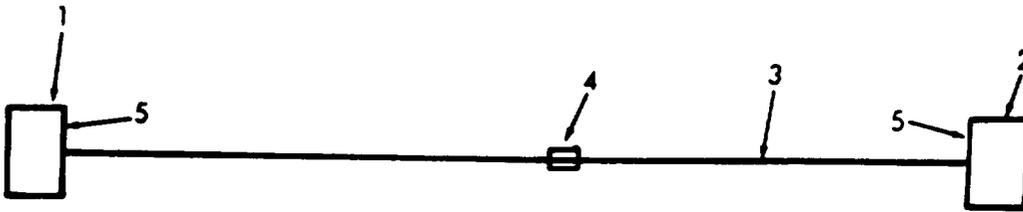

Figure 28. Special relay to precise relay wiring harness.

TM9-6115-465-24P
 TO 35C2-3-445-4
 NAVFAC P-8-625-24P
 SL-4-06858B/06859D

(1) ILLUSTRATION		(2) SMR CODE				(3)		(4) NATIONAL STOCK NUMBER	(5) DESCRIPTION	(6) USABLE ON CODE	(7) QTY INC IN UNITS	(8) USMC QTY PER EQUIP
A FIG. NO.	B ITEM NO.	A ARMY	B AIR FORCE	C NAVY	D USMC	A SSI	B REPL FACTOR	REF NUMBER & MFR CODE	U/M			
28		MFOFF	AFO	AGGGG	AFFZZ			WIRING HARNESS: SPECIAL RELAY TO PRECISE RELAY 72-2238 30554 30554-72-2238 36024	CLB, CLC CZN, DGG	EA	1 1	
28	1	PAFZZ	PAOZZ	PAGZZ	PAFZZ	D	.023	5935-00-845-1349 CONNECTOR, PLUG MS53106R24-28P 96906	CLB, CLC CZM, DGG	EA	1 1	
28	2	PAFZZ	PAOZZ	PAGZZ	PAFZZ	D	.023	5935-00-811-8064 CONNECTOR, PLUG MS3106R24-28S 96906	CLB, CLC CZM, DGG	EA	1 1	
28	3	PAFZZ	PAOZZ	PAGZZ	PAFZZ	D	.080	6145-00-578-6605 WIRE, ELECTRICAL M5086-2-16-9 81349	CLB, CL CZM, DGG	FT	V 490	
28	4	PAFZZ	PAOZZ	PAGZZ		D	.008	5975-00-780-3531 STRAP, CABLE MS3367-5-9 96906	CLB, CLC CZM, DGG	EA	V 232	
28	5	XBFZZ	PAOZZ	PAGZZ	PAFZZ	D	.008	5935-00-823-5322 PLUG, END SEAL MS25251-16 96906	CLB, CLC CZM, DGG	EA	8 67	

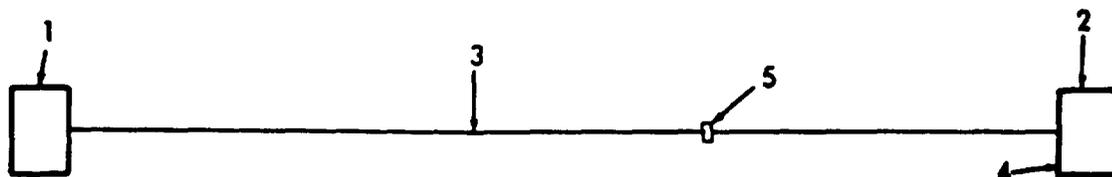

Figure 29. Special relay to static exciter wiring harness.

TM9-6115-465-24P
 TO 35C2-3-446-4
 NAVFAC P-8-625-24P
 SL-4-06858B/06859D

(1) ILLUSTRATION A	(2) SMR CODE A	B	C	D	(3) A	B	(4) NATIONAL STOCK NUMBER	(5) DESCRIPTION REF NUMBER & MFR CODE	(6) USABLE ON CODE	U/M	(7) QTY INC IN UNITS	(8) USMC QTY PER EQUIP	
													B
	MFOFF	AFO	AGGG	AFFZZ				WIRING HARNESS: SPECIAL RELAY TO STATOC EXCITER 72-2220 30554 30554-72-2220 36024 MANUFACTURE FROM:			1	1	
29	1	PAFZZ	PAOZZ	PAGZZ	PAFZZ	D	.023 5935-00-721-1081	CONNECTOR MS3106R146P 96906			EA	1	1
29	2	PAFZZ	PAOZZ	PAGZZ	PAFZZ	D	.023 5935-00-721-0488	CONNECTOR MS3106R14S-6S 96906			EA	1	1
29	3	PAFZZ	PAOZZ	PAGZZ	PAFZZ	D	.080 6145-00-578-6605	WIRE, ELECTRICAL MS0586-2-16-9 81349			FT	V	490
29	4	XBFZZ	PAOZZ	PAGZZ	PAFZZ	D	.008 5935-00-823-5322	PLUG, END SEAL MS25251-16 96906			EA	4	54
29	5	PAFZZ	PAOZZ	PAGZZ	PAFZZ	D	.080 5975-00-111-3208	STRAP CABLE MS3367-5-9 96906			EA	V	232

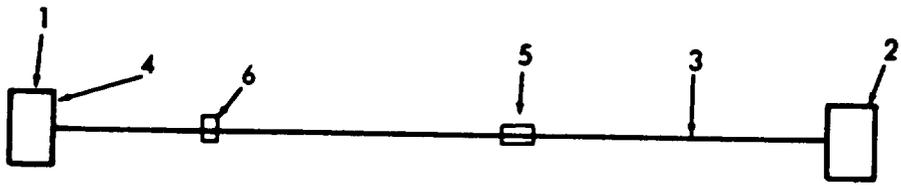

Figure 30. Special relay to control cubicle wiring harness.

TM9-6115-465-24P
 TO 35C2-3-446-4
 NAVFAC P-8-625-24P
 SL4-06858B/06859D

(1) ILLUSTRATION		(2) SMR CODE				(3)		(4) NATIONAL STOCK NUMBER	(5) DESCRIPTION	(6) USABLE ON CODE	(7) QTY INC IN UNITS	(8) USMC QTY PER EQUIP
A FIG. NO.	B ITEM NO.	A ARMY	B AIR FORCE	C NAVY	D USMC	A SSI	B REPL FACTOR	REF NUMBER & MFR CODE	U/M			
30		MFOFF	AOO	AGGGG	AFFZZ			WIRING HARNESS: SPECIAL RELAY TO CONTROL CUBICLE 72-2248 30554 30554-72-2248 36024 MANUFACTURE FROM:	EA	1	1	
30	1	PAFZZ	PAOZZ	PAGZZ	PAFZZ	D	.023	5935-00-723-5281 CONNECTOR, PLUG MS3106R36-7S 96906	EA	1	2	
30	2	PAFZZ	PAOZZ	PAGZZ	PAFZZ	D	.023	5935-00-846-5602 CONNECTOR, PLUG 3456W36-7P 96906	EA	1	1	
30	3	PAFZZ	PAOZZ	PAGZZ	PAFZZ	D	.080	6145-00-578-6605 WIRE, ELECTRICAL M5088-2-16-9 81349	FT	V	490	
30	4	XBFZZ	PAOZZ	PAGZZ	PAFZZ	D	.008	5935-00-823-5322 PLUG, END SEAL MS25251-16 96906	EA	6	54	
30	5	PAFZZ	PAOZZ	PAGZZ	PAFZZ	5	.008	5975-00-111-3208 STRAP, CABLE MS3367-5-9 96906	EA	V	232	
30	6	XBFZZ	PAOZZ	PAOZZ	PAFZZ	D	.008	5340-00-764-7051 CLAMP, LOOP MS21333-69 96906	EA	1	1	

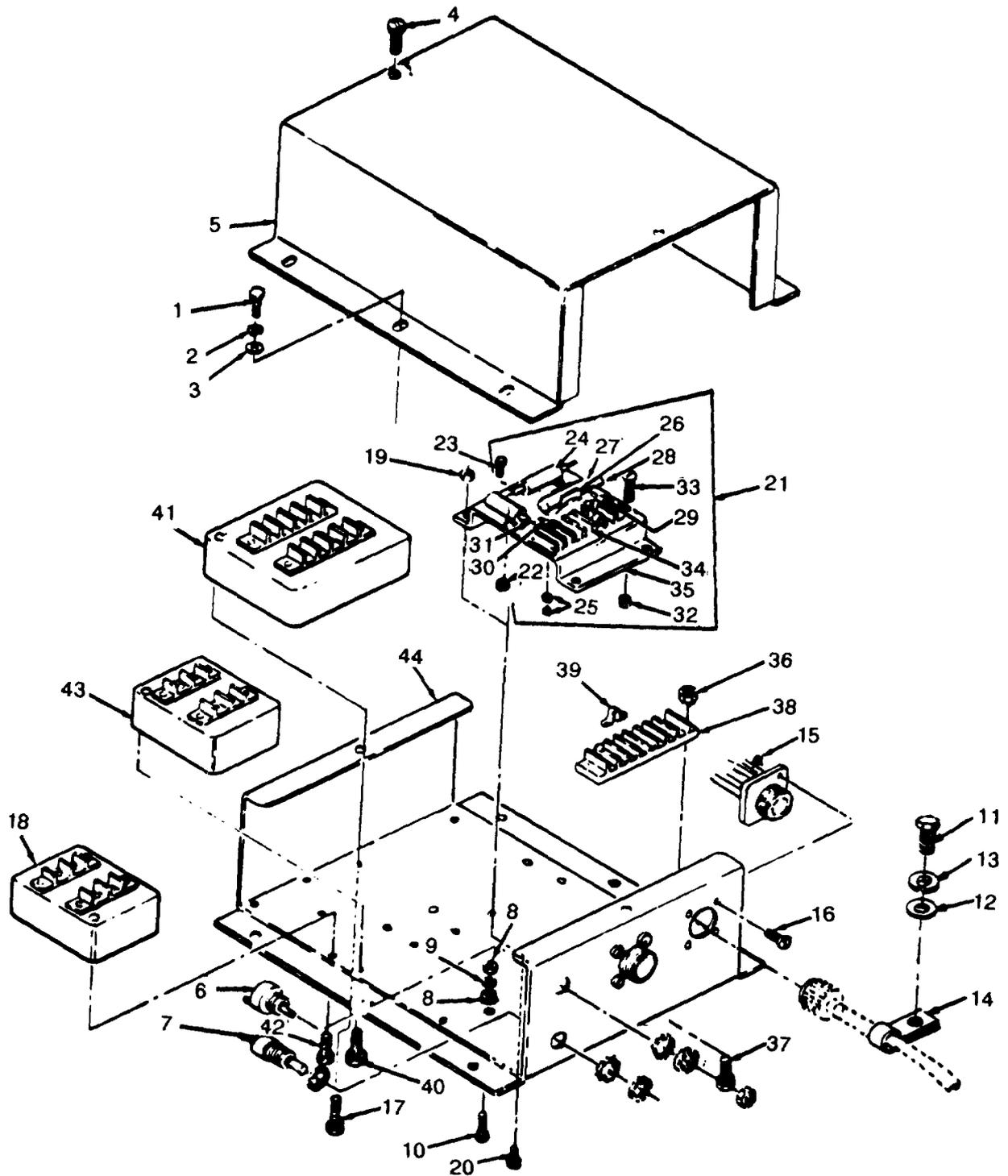

Figure 31. Precise relay. (sheet 1 of 2)

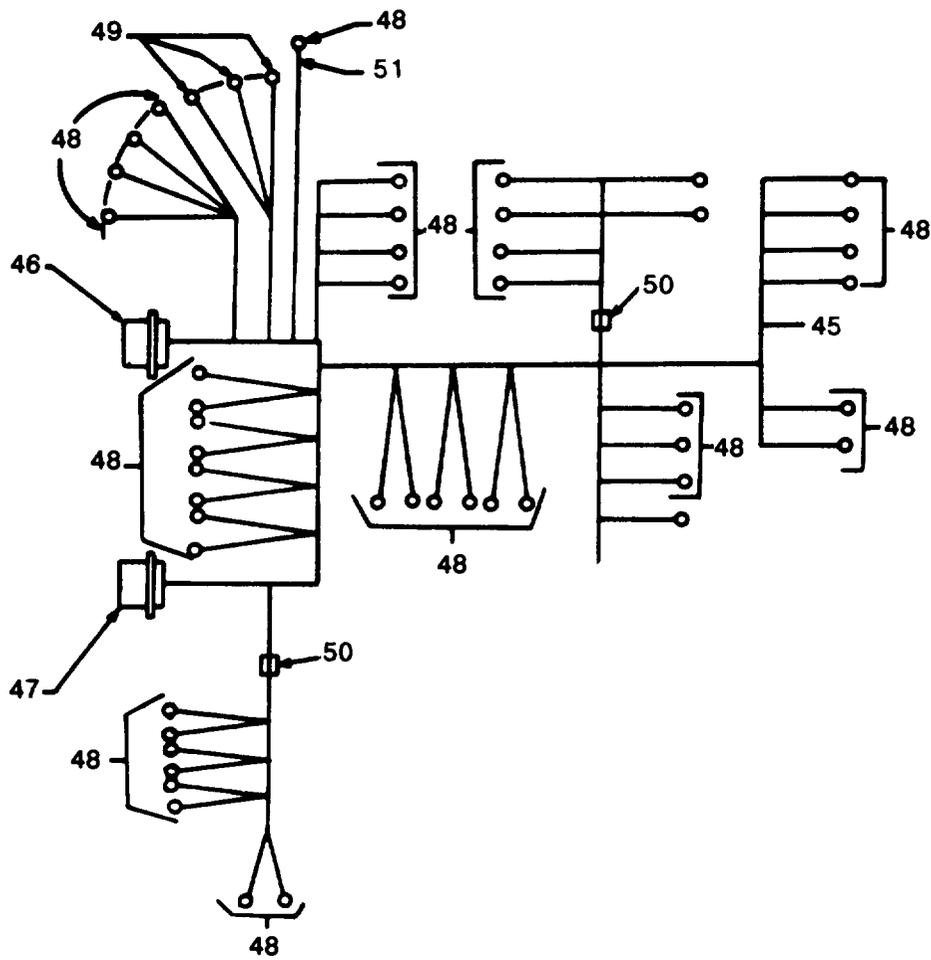

Figure 31. Precise relay. (sheet 2 of 2)

TM9-6115-465-24P
 TO 35C2-3-446-4
 NAVFAC P-8-625-24P
 SL-4-06858B/06859D

ILLUSTRATION A FIG. NO.	B ITEM NO.	SMR CODE (2)					A SSI	B REPL FACTOR	(4) NATIONAL STOCK NUMBER	(5) DESCRIPTION REF NUMBER & MFR CODE	USABLE ON CODE	(6) U/M	(7) QTY INC IN UNITS	(8) USMC QTY PER EQUIP
		A ARMY	B AIR FORCE	C NAVY	D USMC									
31	1	PAFZZ	PAOZZ	PAGZZ	PAFZZ	D	.008	6305-00-0068-0500	SCREW,CAP,HEXAGON HEAD:RELAY ASSEMBLY MTG MS90725-3 96906		EA	6		
31	2	PAFZZ	PAOZZ	PAOZZ	PAFZZ	D	.010	5310-00-582-5965	WASHER,LOCK:RELAY ASSEMBLY MTG MS35338-44 96906	CLB,CLC, CZM,DGG	EA	6		
31	3	PAFZZ	PAOZZ	PAGZZ	PAFZZ	D	.010	5310-00-823-8804	WASHER,FLAT:RELAY ASSEMBLY MTG MS27183-9 96906	CLB,CLC, CZM,DGG	EA	6		
31		PAFHHS	AOO	AGGGG	PAFFF		.250	5945-00-368-8202	RELAY ASSEMBLY:PRECISE 72-2228 30554 30554-72-228 36024 (SAME AS RELAY ASSEMBLY,P/N 72-2253 (30554),EXCEPT WHERE INDIVIDUAL COMPONENTS ARE ANNOTATED)	CLB,CZM	EA	1		
31		PAFHH	AOO	AGGG	PAFFF		.250	5945-00-368-8201	RELAY ASSEMBLY:PRECISE 72-2253 30554 3055-72-2253 36024	CLC,DGG	EA	1		
31	4	PAHZZ	PAOZZ	PAGZZ	PAFZZ	D	.008	5305-00-191-6226	SCREW,WASHER:COVER MTG 69-662-64 30554 P15121-64 45722	CLB,CLC, CZM,DGG	EA	2		
31	5	XBHZZ	XB	XBGZZ	XBFZZ				COVER,RELAY BOX 72-2210 30554 30554-72-2210	CLB,CLC, CZM,DGG	EA	1		
31	6	PAHZZ	PAOZZ	PAGZZ	PAFZZ		.050	5905-00-135-4336	RESISTOR,VARIABLE 69-571-2 30554 RA30LASB253A 81349	CLB,CLC, CZM,DGG	EA	1		
31	7	PAHZZ	PAOZZ	PAGZZ	PAFZZ	D	.050	5930-00-945-1592	SWITCH,TOGGLE MS25126E2 96906	CLB,CZM	EA	1		
31	8	PAHZZ	PAOZZ	PAGZZ	PAFZZ	D	.008	5310-00-052-3632	NUT,WASHER:CHASSIS 69-561-3 30554 511-101800-00 78189	CLB,CLC, CZM,DGG	EA	2		
31	9	PAHZZ	PAOZZ	PAGZZ	PAFZZ	D	.010	5310-00-809-8544	WASHER,FLAT:CHASSIS MS27183-9 96906	CLB,CLC, CZM,DGG	EA	1	22	
31	10	PAHZZ	PAOZZ	PAGZZ	PAFZZ	D	.008	5305-00-984-6193	SCREW,MACHINE:CHASSIS MS35206-245 96906	CLB,CLC, CZM,DGG	EA	1		
31	11	PAHZZ	PAOZZ		PAFZZ	D	.008	5305-00-068-0500	SCREW,CAP,HEXAGON HEAD MS90725-3 96906	CZM	EA	1		
31	12	PAHZZ	PAOZZ		PAFZZ	D	.010	5310-00-823-8804	WASHER,FLAT MS27183-9 96906	CZM	EA	1		
31	13	PAHZZ	PAOZZ		PAFZZ	D	.010	5310-00-582-5965	WASHER,LOCK MS35338-44 96906	CZM	EA	1		
31	14	PAHZZ	PAOZZ		PAFZZ	D	.013	5340-00-088-1254	CLAMP,LOOP MS21333-104 96906	CZM	EA	1		
31	15	PAHZZ	PAOZZ	PAGZZ	PAFZZ	D	.008	5310-00-934-9747	NUT,PLAIN,HEXAGON:WIRING HARNES MTG MS35649-262 96906	CLB,CLC, CZM,DGG	EA	8		
31	16	PAHZZ	PAOZZ	PAGZZ	PAFZZ	D	.008	5305-00-035-6968	SCREW,WASHER,WIRING HARNES MTG 69-662-18 30554 P151211-18 45722	CLB,CLC, CZM,DGG	EA	8		

(1) ILLUSTRATION		(2) SMR CODE				(3)		(4) NATIONAL STOCK NUMBER	(5) DESCRIPTION	(6) USABLE ON CODE	(7) QTY INC IN UNITS	(8) USMC QTY PER EQUIP
A FIG. NO.	B ITEM NO.	A ARMY	B AIR FORCE	C NAVY	D USMC	A SSI	B REPL FACTOR	REF NUMBER & MFR CODE	U/M			
31	17	PAHZZ	PAOZZ	PAGZZ	PAFZZ	D	.008	5305-00-036-6977	SCREW,WASHER:RELAY MTG 69-662-33 30554 P15121-33 45722	CLB,CLC, CZM,DGG	EA	4
31	18	PAHZZ	PAOZZ	PAGZZ	PAFZZ		.050	5945-00-922-0030	RELAY,UNDER VOLTAGE 70-1120 30554	CLB,CLC, CZM,DGG	EA	1
31	19	PAHZZ	PAOZZ	PAGZZ	PAFZZ	D	.008	5305-00-036-6968	SCREW,WASHER:RESISTOR MTG MS35649-262 96906	CLB,CLC, CZM,DGG	EA	4
31	20	PAHZZ	PAOZZ	PAGZZ	PAFZZ	5	.008	5305-00-036-6968	SCREW,WASHER:RESISTOR MTG 69-662-18 30554 CZM,CLC P15121-18 45722	CLB,CLC,	EA	4
31	21	XBHZZ	AOZZ	AGGGG	AFZZ			5998-01-256-1741	ELECTRONIC COMPONENT 72-2264 30554 30554-71-2264 36024	CLB,CLC CZM,DGG	EA	1
31	22	PAHZZ	PAOZZ	PAGZZ	PAFZZ	D	.008	5310-00-063-7360	NUT,WASHER 69-561-2 30554 511-081800-00 78189	CLB,CLC,	EA	4
31	23	PAHZZ	PAOZZ	PAGZZ	PAFZZ	D	.008	5305-00-984-4988	SCREW,MACHINE:RESISTOR MTG MS35206-228 96906	CLB,CLC, CZM,DGG	EA	4
31	26	PAHZZ	PAOZZ	PAGZZ	PAFZZ		.050	5905-00-140-9086	RESISTOR,FIXED RER70F2940R 81349	CLB,CLC, CZM,DGG	EA	2
31	25	XBHZZ	PAOZZ	XBGZZ	XBFZZ			5325-00-177-4162	EYELET:BRACKET 72-2082 30554 G23-4 57771	CLB,CLC CZM,DGG	EA	2
31	26	PAHZZ	PAOZZ	PAGZZ	PAFZZ	D	.030	5340-00-725-6033	CLIP,TENSION M24066/2-321 81329	CLB,CLC, CZM,DGG	EA	1
31	27	PAHZZ	PAOZZ	PAGZZ	PAFZZ		.050	5910-01-100-8802	CAPACITOR 70-1524 30554 TAE60-50SBNTINIFORM 02567	CLB,DGG	EA	1
31	27	PAHZZ	PAOZZ	PAGZZ	PAFZZ				CAPACITOR ASSEMBLY 83-2004 30554	CLC,CZM	EA	1
31	28	XBHZZ	PAOZZ	XBGZZ	XBFZZ				TUBING,INSULATION MIL1631TYPEFORMULA81349	CLB,CLC, CZM,DGG	FT	V
31	29	PAHZZ	PAOZZ	PAGZZ	PAFZZ	D	.050	5940-00-577-3807	TERMINAL,LUG MS25036-145 96906	CLB,CLC CZM,DGG	EA	2
31	30	PAHZZ	PAOZZ	PAGZZ	PAFZZ	D	.050	5940-00-283-5280	TERMINAL,LUG MS25036-106 96906	CLB,CLC CZM,DGG	EA	4
31	31	PAHZZ	PAOZZ	PAGZZ	PAFZZ	D	.080	6145-00-578-6605	WIRE,ELECTRICAL M5086-2-16-9 81349	CLB,CLC CZM,DGG	FT	V
31	32	PAHZZ	PAOZZ	PAGZZ	PAFZZ	D	.008	5310-00-063-7360	NUT,WASHER:TERMINAL BOARD MTG 69-561-2 30554 511-081800-00 78189	CLB,CLC CZM,DGG	EA	2
31	33	PAHZZ	PAOZZ	PAGZZ	PAFZZ	D	.008	5305-00-889-3001	SCREW,MACHINE:TERMINAL BOARD MTG MS35206-231 96906	CLB,CLC, CZM,DGG	EA	2
31	34	XBHZZ	PAOZZ	XBOZZ	XBFZZ			5940-00-963-6047	TERMINAL BOARD 37TB6 81349	CLB,CLC CZM,DGG	EA	1
31	35	XBHZZ	MOO	XBGZZ	XBFZZ				BRACKET,MOUNTING 72-2265 30554 30554-72-2265 36024	CLB,CLC, CZM,DGG		1

(1) ILLUSTRATION		(2) SMR CODE				(3)			(4)	(5)	(6)	(7)	(8)
A	B	A	B	C	D	A	B	NATIONAL STOCK NUMBER	DESCRIPTION	USABLE ON CODE	U/M	QTY INC IN UNITS	USMC QTY PER EQUIP
FIG. NO.	ITEM NO.	ARMY	AIR FORCE	NAVY	USMC	SSI	REPL FACTOR		REF NUMBER & MFR CODE				
31	36	PAHZZ	PAOZZ	PAGZZ	PAFZZ	D	.008	5310-00-063-7360	NUT, WASHER: TERMINAL BOARD MTG 69-561-2 30554 511-081800-00 78189	CLB, CLC, CZM, DGG	EA	2	
31	37	PAHZZ	PAOZZ	PAGZZ	PAFZZ	D	.008	5305-00-889-3001	SCREW, MACHINE: TERMINAL BOARD MTG MS35206-231 96906	CLB, CLC, CZM, DGG	EA	2	
31	38	XBHZZ	PAOZZ	PAGZZ	XBFZZ			5940-00-983-6049	TERMINAL BOARD 37TB8 81349	CCLB, CLCC, CZM, DGG	EA	1	
31	39	XBHZZ	XB	XBGZZ	XBFZZ			5940-00-632-7234	LINK, TERMINAL 69-651-1 30554 600J 75382	CLB, CLC, CZM, DGG	EA	2	
31	40	PAHZZ	PAOZZ	PAGZZ	PAFZZ	D	.008	5305-00-036-6977	SCREW, WASHER: RELAY MTG 69-662-33 30554 P15121-33 45722	CLB, CLC, CZM, DGG	EA	4	
31	41	PAHZZ	PAOZZ	PAGZZ	PAFZZ		.050	5945-00-430-3576	RELAY, UNDER FREQUENCY 70-1119 30554	CLB, CZM, DGG	EA	1	
31	41	PAHZZ	PAOZZ	PAGZZ	PAFZZ		.050	5945-00-922-0031	RELAY, UNDER FREQUENCY 70-1141 30554	CLC, DGG	EA	1	
31	42	PAHZZ	PAOZZ	PAGZZ	PAFZZ		.008	5305-00-036-6977	SCREW, WASHER: RELAY MTG 69-662-33 30554 P15121-33 45722	CLB, CLC, CZM, DGG	EA	4	
31	43	PAHZZ	PAOZZ	PAGZZ	PAFZZ		.050	5945-00-450-9136	RELAY, PERMISSIVE PARALLEL 70-118 30554	CLB, CLC, CZM, DGG	EA	1	
31	44	XBHZZ	XB	XBGZZ	XBFZZ				CHASSIS, BOX 72-2244 30554 30554-72-2244 36024	CLB, CZM, DGG	EA	1	
31	44	XBHZZ	XB	XBGZZ	XBFZZ			6115-00-610-2088	CHASIS, BOX 72-2266 30554 30554-72-2266 36024	CLC, DGG	EA	1	
31		MHHH	PBOZZ		AFFZZ				WIRING HARNESS 72-2260 30554 30554-72-2260 36024 MANUFACTURE FROM:	CLC, DGG	EA	1	
31	45	PAHZZ	PAOZZ	PAGZZ	PAFZZ	D	.080	6145-00-578-6602	WIRE, ELECTRICAL M5088-2-18-9 81349	CLC, DGG, FT		8	
31	46	PAHZZ	PAOZZ	PAGZZ	PAFZZ	D	.023	5935-00-721-0708	CONNECTOR, RECPTACLE MS3102R24-28P 96906	CLC, DGG	EA	1	
31	47	PAHZZ	PAOZZ	PAGZZ	PAFZZ	D	.023	5935-00-721-0501	CONNECTOR, RECEPTACLE MS3102R24-28S 96906	CLC, DGG	EA	1	
31	48	PAHZZ	PAOZZ	PAGZZ	PAFZZ	5	.050	5940-00-204-8966	TERMINAL, LUG MS25036-102 96906	CLC, DGG	EA	46	
31	49	PAHZZ	PAOZZ	PAGZZ	PAFZZ	D	.050	5940-00-557-1629	TERMINAL, LUG MS25036-149 96906	CLC, DGG	EA	4	
31	50	PAHZZ	PAOZZ	PAGZZ	PAFZZ	D	.008	5975-00-111-3208	STRAP, CABLE MS3367-5-9 96906 (AS REQUIRED)	CLC, DGG	EA	V	
31	51	PAHZZ	PAOZZ		PAFZZ	D	.008	5970-00-954-1622	INSULATION, SLEEVING M23053/5-105-0 81349	CLB, CLC, CZM, DGG	FT	2	
31		MHHH	PBOZZ		AFFZZ				WIRING HARNESS 72-2242 30554	CLB, CZM, DGG	EA	1	

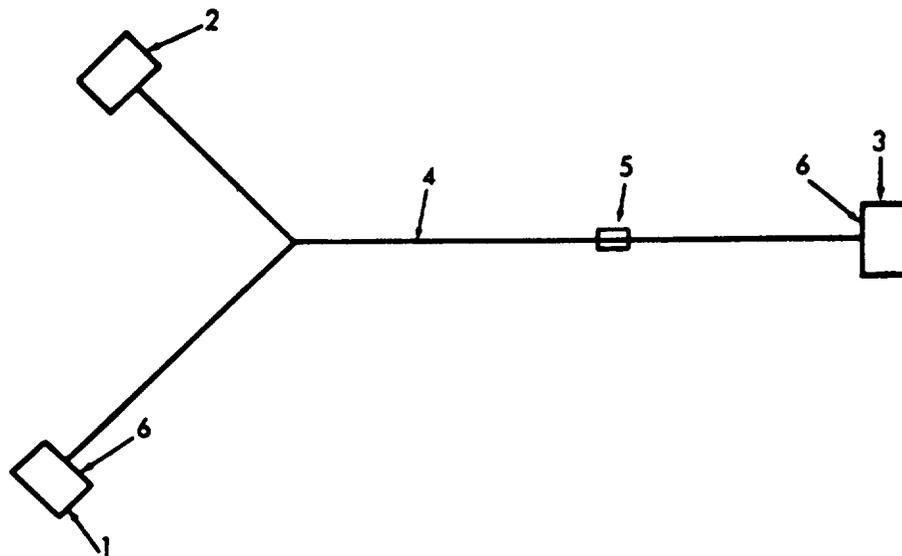

Figure 32. Precise relay to governor control unit wiring harness.

TM9-6115-465-24P
 TO 35C2-3-446-4
 NAVFAC P-8-625-24P
 SL-4-06858B/06859D

(1) ILLUSTRATION		(2) SMR CODE				(3)		(4) NATIONAL STOCK NUMBER	(5) DESCRIPTION	(6) USABLE ON CODE	(7) QTY INC IN UNITS	(8) USMC QTY PER EQUIP
A FIG. NO.	B ITEM NO.	A ARMY	B AIR FORCE	C NAVY	D USMC	A SSI	B REPL FACTOR	REF NUMBER & MFR CODE	U/M			
32		MFOFF	AOO	AGGGG	AFFZZ			WIRING HARNESS:PRECISE RELAY TO GOVERNOR CONTROL UNIT 72-224 30554 30544-72-2245 36024 MANUFACTURE FROM:	CLB,CLC, CZM,DGG	EA	1	
32	1	PAFZZ	PAOZZ	PAGZZ	PAFZZ	D	.023	5935-00-814-9781	CONNECTOR,PLUG MS3106R22-14S 96906	CLB,CLC CZM,DGG	EA	1
32	2	PAFZZ	PAOZZ	PAGZZ	PAFZZ	D	.023	5935-00-432-8967	CONNECTOR,PLUG MS3106R10SL4SC 96906	CLB,CLC, CZM,DGG	EA	1
32	3	PAFZZ	PAOZZ	PAGZZ	PAFZZ	D	.023	5935-00-845-1349	CONNECTOR,PLUG MS3106R24-28P 96906	CLB,CLC CZM,DGG	EA	1
32	4	PAFZZ	PAOZZ	PAGZZ	PAFZZ	D	.080	6145-00-578-6605	WIRE,ELECTRICAL M5086-216-9 81349	CLB,CLC CZM,DGG	FT	V
32	5	PAFZZ	PAOZZ	PAGZZ	PAFZZ	D	.008	5975-00-111-3208	STRAP,CABLE MS3367-5-9 96906	CLB,CLC, CZM,DGG	EA	V
32	6	XBFZZ	PAOZZ	PAGZZ	PAFZZ	D	.008	5935-00-823-5322	PLUG,END,SEAL MS25251-16 96906	CLB,CLC, CZM,DGG	EA	7

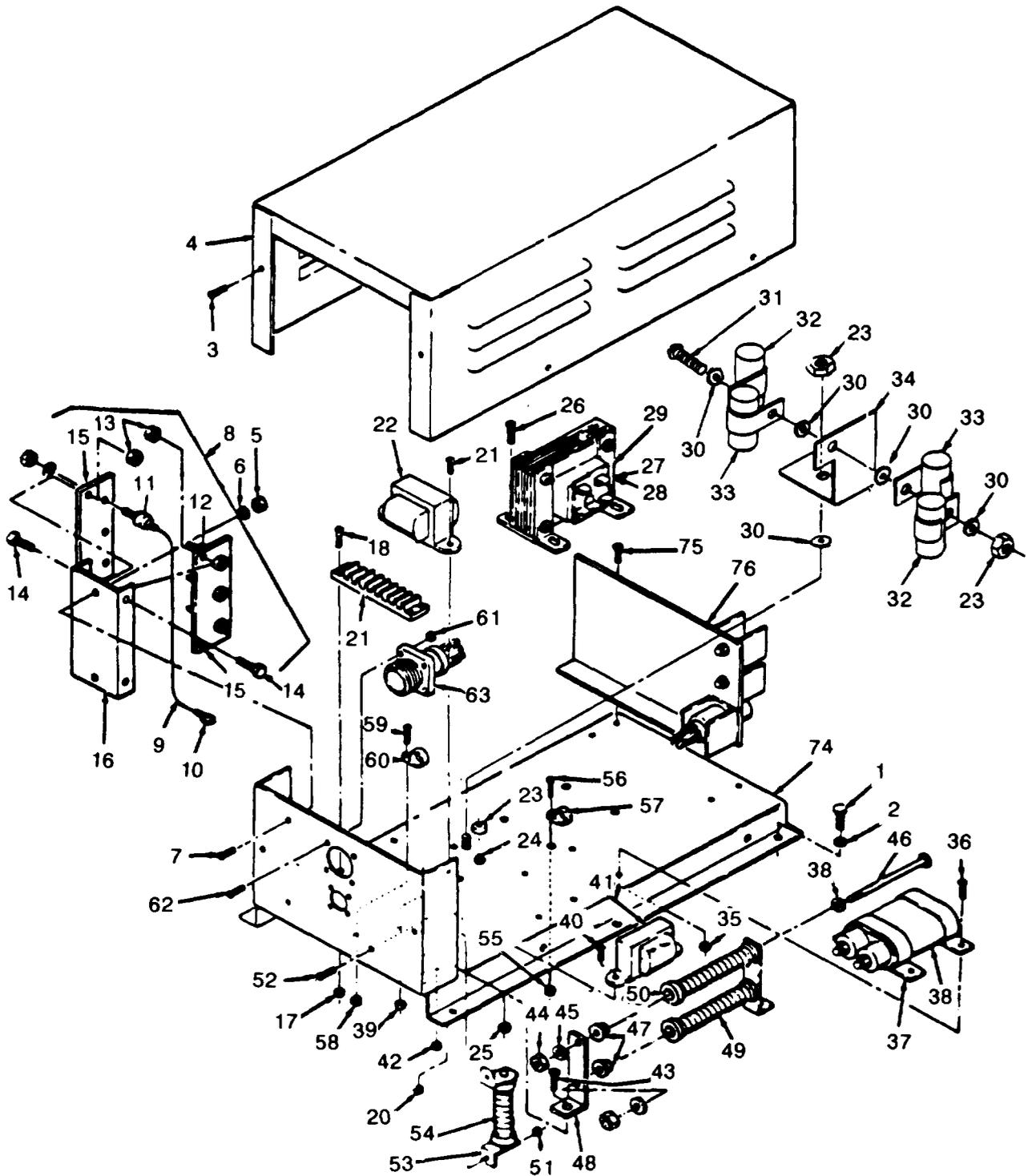

Figure 33. Static exciter and voltage regulator. (sheet 1 of 4)

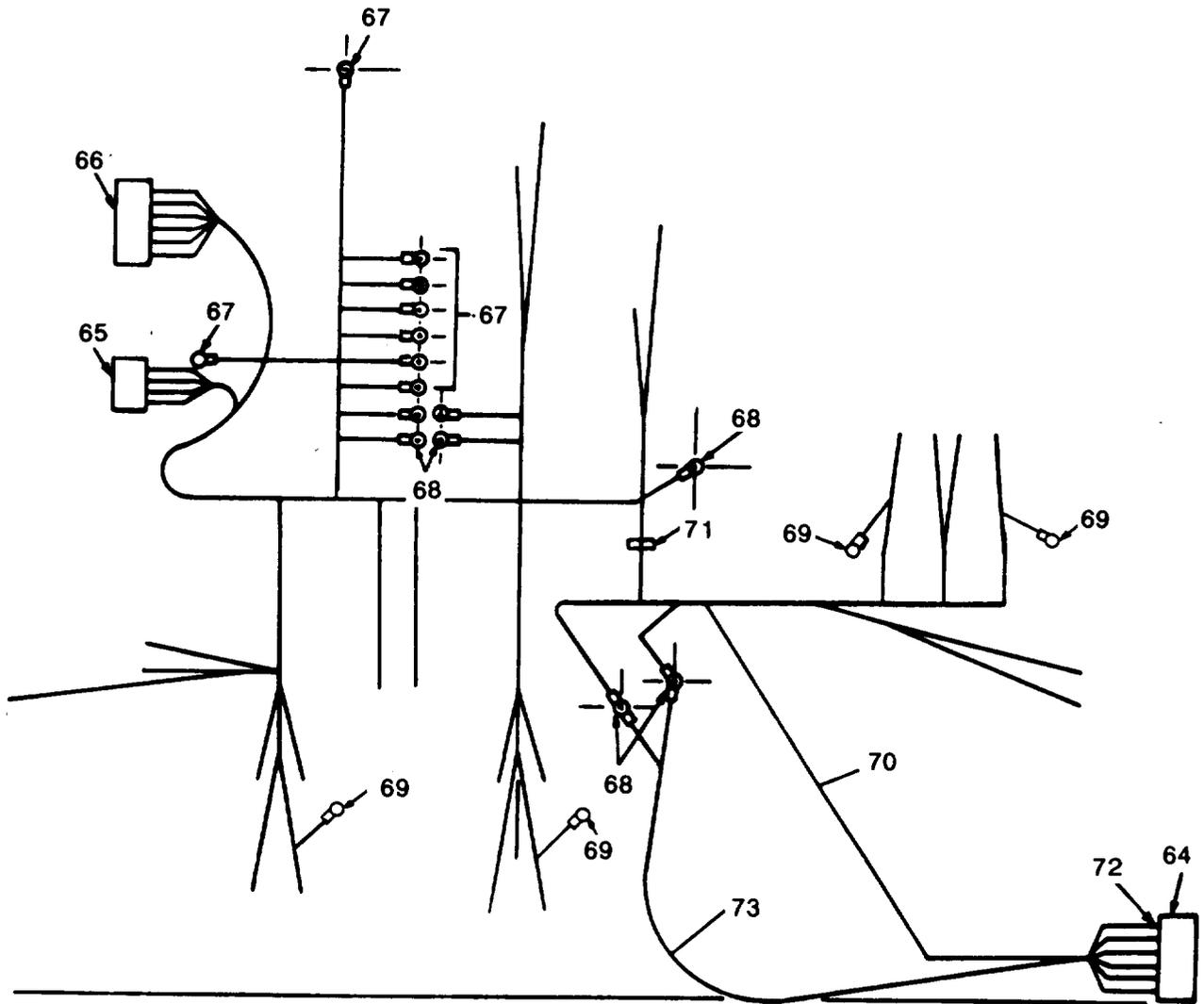

Figure 33. Static exciter and voltage regulator. (sheet 2 of 4)

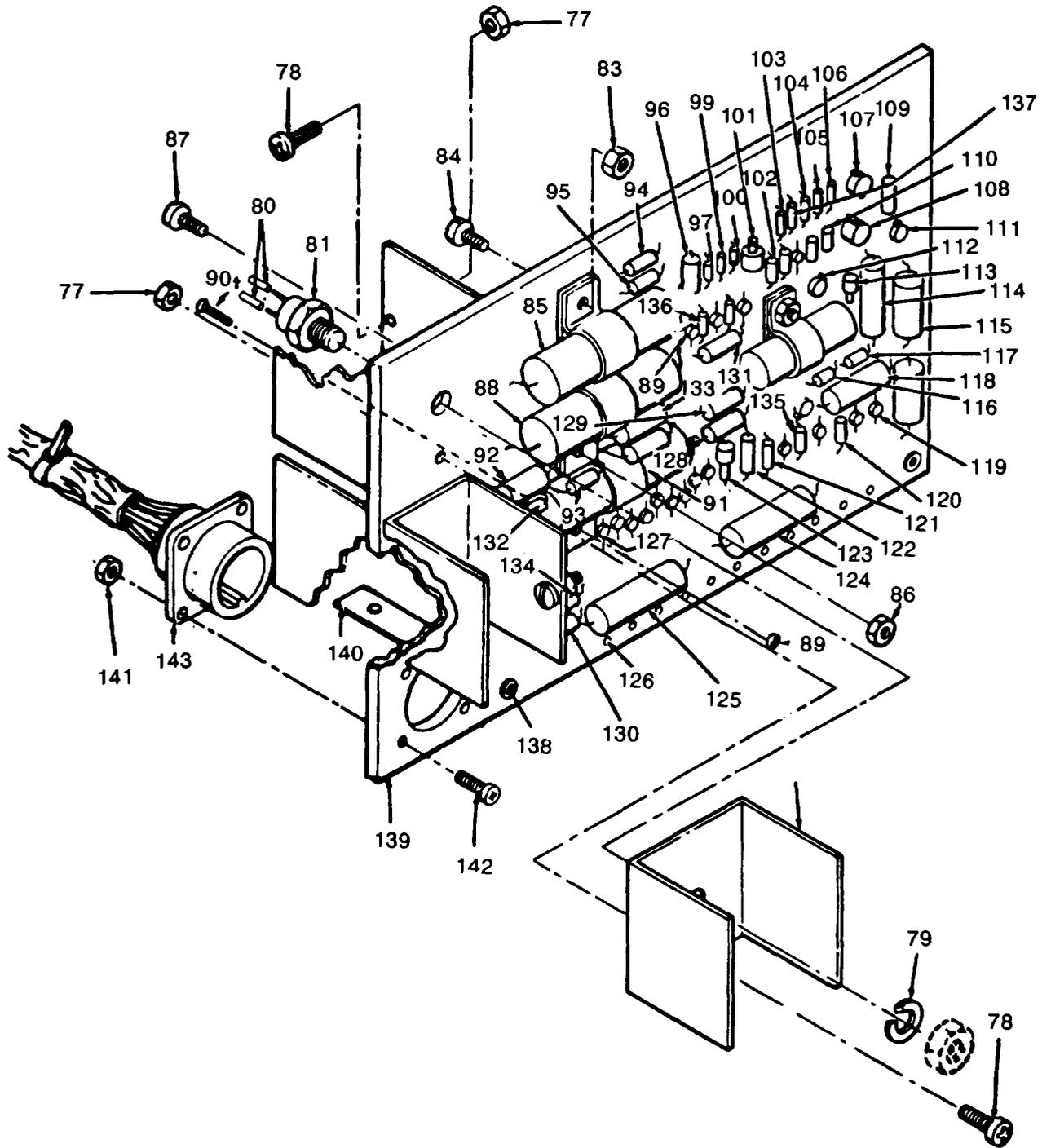

Figure 33. Static exciter and voltage regulator. (sheet 3 of 4)

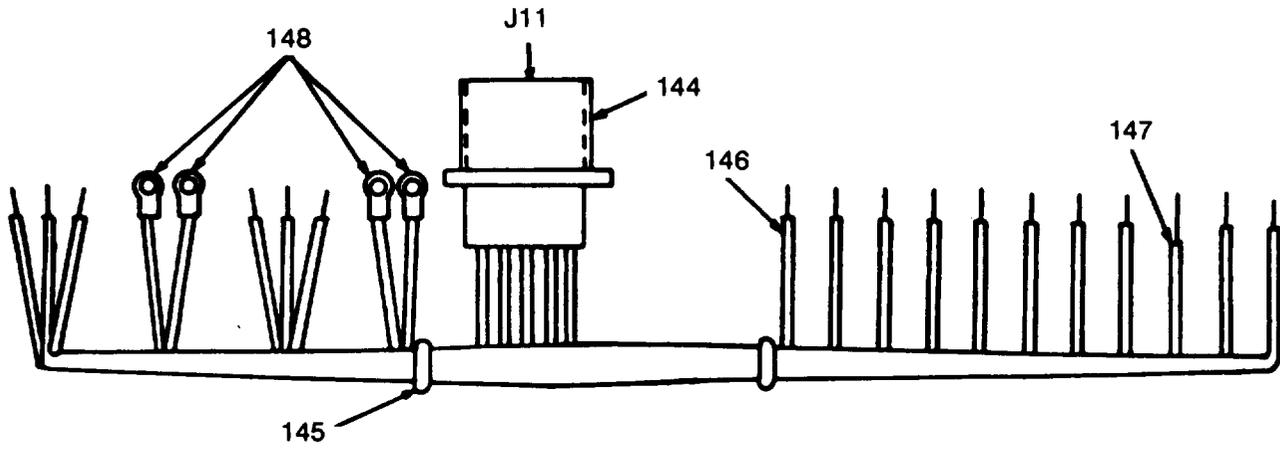

Figure 33. Static exciter and voltage regulator. (sheet 4 of 4)

(1) ILLUSTRATION A FIG. NO.	(2) SMR CODE B ITEM NO.	(3) A ARMY	(3) B AIR FORCE	(3) C NAVY	(3) D USMC	(3) E SSI	(4) NATIONAL STOCK NUMBER B REPL FACTOR	(5) DESCRIPTION REF NUMBER & MFR CODE	(6) USABLE ON CODE U/M	(7) QTY INC IN UNITS	(8) USMC QTY PER EQUIP	
33	1	PAFZZ	PAOZZ	PAGZZ	PAFZZ	D	.008	5306-00-225-8497 BOLT,MACHINE:EXCITER MTG MS90725-32 96906	EA	6	44	
33	2	PAFZZ	PAOZZ	PAGZZ	PAFZZ	D	.010	5310-00-407-9566 WASHER,LOCKEXCITER MTG MS35338-45 96906	EA	6	26	
33		PAFHH	PAOFF	AHHHH	AFFFF			6115-00-363-3957 STATIC EXCITER 72-2601 30554 30554-72-2601 36024 (SAME AS STATIC EXCITER,P/N 72-2600 (30554), EXCEPT WHERE INDIVIDUAL COMPONENTS ARE ANNOTATED)	CLA,CLB CZN,CZM	EA	1	1
33		PAFHH	PAOFF	AHHHH	AFFFF			6115-00-370-2726 STATIC EXCITER 72-2600 30554 30554-72-2600 36024	CLC,DGG	EA	1	1
33	3	PAFZZ	PAOZZ	PAGZZ	PAFZZ	D	.008	5305-00-989-7434 SCREW,MACHINE:COVER MTG MS35207-263 96906	EA	6	20	
33	4	XBFZZ	XB	XBGZZ	XBFZZ			COVER,CHASSIS 72-2605 30554 30554-72-2605 36024	EA	1	1	
33	5	PAFZZ	PAOZZ	PAGZZ	PAFZZ	D	.008	5310-01-012-3595 NUT,WASHER:HEAT SINK MTG 69-561-6 30554 511-101800-50 78189	EA	2	12	
33	6	PAFZZ	PAOZZ	PAGZZ	PAFZZ	D	.010	5310-00-823-8804 WASHER,PLAT:HEAT SINK MTG MS27183-9 96906	EA	2	45	
33	7	PAFZZ	PAOZZ	PAGZZ	PAFZZ	D	.008	5305-00-989-7434 SCREW,MACHINE:HEAT SINK MTG MS35207-263 96906	EA	2	20	
33	8	XBFZZ	AFO	AGGGG	APFZZ			HEAT SINK ASSEMBLY 72-2606 30554 30554-72-2606 36024	EA	1	1	
33	9	PAFZZ	PAOZZ	PAGZZ	PAFZZ	D	.080	6145-00-578-6602 WIRE,ELECTRICAL M5086-2-18-9 81349	FT	V	232	
33	10	PAFZZ	PAOZZ	PAGZZ	PAFZZ	D	.050	5940-00-204-8966 TERMINAL,LUG MS25036-102 96906	EA	3	381	
33	11	PAFZZ	PAOZZ	PAGZZ	PAFZZ		.040	5961-00-724-5970 SEMICONDUCTOR JAN1N1204A 81349	EA	3	5	
33	12	PAFZZ	PAOZZ	PAGZZ	PAFZZ		.050	5961-00-998-9317 SEMICONDUCTOR JAN1N1204RA 81349	EA	3	5	
33	13	PAFZZ	PAOZZ	PAGZZ	PAFZZ	D	.008	5310-01-012-3595 NUT,WASHER:HEAT SINK MTG 69-561-6 30554 511-101800-50 78189	EA	4	12	
33	14	PAFZZ	PAOZZ	PAGZZ	PAFZZ	D	.008	5305-00-989-7434 SCREW,MACHINE PANHEAD:HEAT SINK MTG MS35207-263 81349	EA	4	4	
33	15	XBFZZ	XB	XBGZZ	XBFZZ			HEAT SINK 72-2621 30554 30554-72-2621 36024	EA	2	2	
33	16	XBFZZ	XB	XBGZZ	XBFZZ			SUPPORT,HEAT SINK 72-2620 30554 30554-72-2620 36024	EA	1	1	
33	17	PAFZZ	PAOZZ	PAGZZ	PAFZZ	D	.008	5310-00-063-7360 NUT,WASHER:TERMINAL BOARD MTG 69-561-2 30554 511-101800-00 78189	EA	4	51	
33	18	PAFZZ	PAOZZ	PAGZZ	PAFZZ	D	.008	5305-00-889-3001 SCREW,MACHINE:TERMINAL BOARD MTG MS35206-231 96906	EA	4	12	

(1) ILLUSTRATION A FIG. NO.	(2) SMR CODE B ITEM NO.	(3) A ARMY	(3) B AIR FORCE	(3) C NAVY	(3) D USMC	(3) E SSI	(4) NATIONAL STOCK NUMBER	(5) DESCRIPTION REF NUMBER & MFR CODE	(6) USABLE ON CODE U/M	(7) QTY INC IN UNITS	(8) USMC QTY PER EQUIP	
33	19	XBFZZ	PAOZZ	PAGZZ	XBFZZ		5940-00-983-6049	TERMINAL BOARD 37TB8 81349	EA	1	1	
33	20	PAFZZ	PAOZZ	PAGZZ	PAFZZ	D	.008 5310-00-052-3632	NUT, WASHER: TRANSFORMER MTG 69-561-3 30554 511-08-800-00 78189	EA	2	54	
33	21	PAFZZ	PAOZZ	PAGZZ	PAFZZ	D	.008 5305-00-984-6193	SCREW, MACHINE: TRANSFORMER MTG MS35206-245 96906	EA	2	17	
33	22	PAFZZ	PAOZZ	PAGZZ	PAFZZ		.050 5950-00-603-6986	TRANSFORMER 72-2607 30554 369BZ10G01 19899	EA	1	1	
33	23	PAFZZ	PAOZZ	PAGZZ	PAFZZ	D	.008 5310-00-186-5173	NUT, WASHER: TERMINAL 69-561-5 30554 511-251800-00 78189	CZN, CZM, DGG	EA	3	52
33	24	PAFZZ	PAOZZ	XBGZZ	PAFZZ		5307-01-108-0725	TERMINAL 72-2633 30554 FH04Z0-8C1 46384	EA	1		
33	25	PAFZZ	PAOZZ	PAGZZ	PAFZZ	D	.008 5310-00-696-5173	NUT, WASHER: TRANSFORMER MTG 69-561-3 30554 511-251800-00 71789	CLA, CLB, CZN, CZM	EA	4	52
33	25	PAFZZ	PAOZZ	PAGZZ	PAFZZ	D	.008 5310-01-012-3595	NUT, WASHER: TRANSFORMER MTG 69-561-6 30554 511-101800-50 78189	CLC, DGG	EA	4	52
33	26	PAFZZ	PAOZZ	PAGZZ	PAFZZ	D	.008 5305-00-984-6192	SCREW, MACHINE: CAPACITOR MTG MS35206-281 96906	CLA, CLB CZN, CZM	EA	4	4
33	26	PAFZZ	PAOZZ	PAGZZ	PAFZZ	D	.008 5305-00-984-6192	SCREW, MACHINE: TRANSFORMER MTG MS35207-263 96906	CLA, DGG	EA	4	4
33	27	PAFZZ	PAOZZ		PAFZZ	D	.008 5970-00-954-1622	INSULATION, SLEEVING M23053/5-105-0 81349	CZN	FT	V	
33	28	PAFZZ	PAOZZ		PAFZZ	D	.008 5970-00-815-1295	INSULATION, SLEEVING M23053/5-5-108-0 81349	CZM	FT	V	
33	29	PAFZZ	PAOZZ	PAGZZ	PAFZZ		.050 5950-00-600-0840	TRANSFORMER 72-2609 30554 369B106G01 19899	CLA, CLB, CZN, CZM	EA	1	
33	29	PAFZZ	PAOZZ	PAGZZ	PAFZZ		.050 5950-00-600-0842	TRANSFORMER 72-2609 30554 369B208G01 78189	CLC, DGG	EA	1	1
33	30	PAFZZ	PAOZZ		PAFZZ	D	.010 5310-00-067-6357	WASHER, LOCK MS45904-69 96906	CZN, CZM DGG	EA	5	
33	31	PAFZZ	PAOZZ		PAFZZ	D	.008 5305-01-072-9133	SCREW, WASHER ASSEMBLED 69-562-81 30554 P15121-81 45722	CZN, CZM DGG	EA	1	
33	32	PAFZZ	PAOZZ		PAFZZ		.050 5910-00-577-1349	CAPACITOR CA36KFW103 81349	CZN, CZM, DGG	EA	2	
33	33	PAFZZ	PAOZZ		PAFZZ		.050 5910-00-577-1348	CAPACITOR CA37KFW103 81349	CZN, CZM DGG	EA	2	
33	34	XBFZZ	MOO		XBFZZ			BRACKET, RFI CAPACITOR 77-502 30554	CZN, CZM DGG	EA	1	
33	35	PAFZZ	PAOZZ	PAGZZ	PAFZZ	D	.008 5310-01-012-3595	NUT, WASHER: CAPACITOR MTG 69-561-6 30554 511-101800-50 78189	EA	4	12	

(1) ILLUSTRATION A FIG. NO.	(2) SMR CODE B ITEM NO.	(3) A ARMY	(3) B AIR FORCE	(3) C NAVY	(3) D USMC	(3) E SSI	(4) NATIONAL STOCK NUMBER B REPL FACTOR	(5) DESCRIPTION REF NUMBER & MFR CODE	(6) USABLE ON CODE U/M	(7) QTY INC IN UNITS	(8) USMC QTY PER EQUIP	
33	36	PAFZZ	PAOZZ	PAGZZ	PAFZZ	D	.008	5305-00-989-7434 SCREW,MACHINE:CAPACITOR MTG MS35207-263 96906	EA	4	20	
33	37	XBFZZ	XB	XBGZZ	XBFZZ			BRACKET MOUNTING 72-2614-2 30554 30393-9 14655	CLA, CLB CZN, CZM	EA	2	2
33	37	XBFZZ	XB	XBGZZ	XBFZZ			BRACKET MOUNTING 72-2614-1 30554 30393-5 14655	CLC, DGG,	EA	2	2
33	38	PAFZZ	PAOZZ	PAGZZ	PAFZZ		.050	5910-00-603-9050 CAPACITOR 72-2612-2 30554 SCRGL15 14655	CLA, CLB CZN, CZM	EA	1	1
33	38	PAFZZ	PAOZZ	PAGZZ	PAFZZ		.050	5910-00-603-9041 CAPACITOR 72-2612-1 30554 SCRGL12 14655	CLC, CGG	EA	1	1
33	39	PAFZZ	PAOZZ	PAGZZ	PAFZZ	D	.008	5310-00-052-3632 NUT,WASHER TRANSFORMER MTG 69-561-3 30554 511-08-1800-00 78189	EA	2	54	
33	40	PAFZZ	PAOZZ	PAGZZ	PAFZZ	D	.008	5305-00-984-6193 SCREW,MACHINE:TRANSFORMER MTG MS35206-245 96906	EA	2	17	
33	41	PAFZZ	PAOZZ	PAGZZ	PAFZZ		.050	5950-00-600-0843 TRANSFORMER 72-2618 30554 369B209G01 19899	EA	1	1	
33	42	PAFZZ	PAOZZ	PAGZZ	PAGZZ	D	.008	5310-01-012-3595 NUT,WASHER:RESISTOR BRACKET MTG 69-561-6 30554 511-101800-50 78189	EA	2	12	
33	43	PAFZZ	PAOZZ	PAGZZ	PAFZZ	D	.008	5305-00-989-7434 SCREW,MACHINE:RESISTOR BRACKET MTG MS35207-263 96906	EA	2	20	
33	44	PAFZZ	PAOZZ	PAGZZ	PAFZZ	D	.008	5310-01-012-3595 NUT,WASHER:RESISTOR BRACKET MTG 69-561-6 30554 511-101800-50 78189	EA	2	12	
33	45	PAFZZ	PAOZZ	PAGZZ	PAFZZ	D	.010	5310-00-851-2242 WASHER,SHOULDER:RESISTOR BRACKET MTG MS75009-5 96906	EA	4	4	
33	46	PAFZZ	PAOZZ	PAGZZ	PAFZZ	D	.008	5305-00-954-1992 SCREW,MACHINE:RESISTOR MTG MS75009-19 96906	EA	2	2	
33	47	PAFZZ	PAOZZ	PAGZZ	PAFZZ	D	.010	5970-00-861-3556 WASHER,MICA:RESISTOR MTG MS75009-3 96906	EA	4	4	
33	48	XBFZZ	XB	XBGZZ	XBFZZ			BRACKET MOUNTING:RESISTOR 72-2615 30554 GL23 44655	EA	2	2	
33	49	PAFZZ	PAOZZ	PAGZZ	PAFZZ		.040	5905-00-636-7778 RESISTOR,FIXED RW34V100 81349	EA	1	1	
33	50	PAFZZ	PAOZZ	PAGZZ	PAFZZ		.040	5905-00-853-0154 RESISTOR RW35V511 81349	EA	1	1	
33	51	PAFZZ	PAOZZ	PAGZZ	PAFZZ	D	.008	5310-01-012-3595 NUT,WSAHER:RESISTOR MTG 69-561-6 30554 511-101800-50 78189	EA	2	12	
33	52	PAFZZ	PAOZZ	PAGZZ	PAFZZ	D	.008	5305-00-989-7434 SCREW,MACHINE:RESISTOR MTG MS35207-263 96906	EA	2	20	
33	53	XBFZZ	PAOZZ	XBGZZ	XBFZZ			5905-00-860-6276 BRACKET,RESISTOR MS75009-33 96906	EA	1	2	

(1) ILLUSTRATION		(2) SMR CODE				(3)		(4)	(5)	(6)	(7)	(8)
A	B	A	B	C	D	A	B	NATIONAL STOCK NUMBER	DESCRIPTION	USABLE ON CODE	QTY INC IN UNITS	USMC QTY PER EQUIP
FIG. NO.	ITEM NO.	ARMY	AIR FORCE	NAVY	USMC	SSI	REPL FACTOR	REF NUMBER & MFR CODE		U/M		
33	54	PAFZZ	PAOZZ	PAGZZ	PAFZZ		.040	5905-00-846-8140	RESISTOR, FIXED RW33V511 81349	EA	1	1
33	55	PAFZZ	PAOZZ	PAGZZ	PAFZZ	D	.008	5310-00-052-3632	NUT, WASHER: CLAMP MTG 69-561-3 30554 511-08100-00 78189	EA	2	54
33	56	PAFZZ	PAOZZ	PAGZZ	PAFZZ	D	.008	5305-00-984-6193	SCREW, MACHINE: CLAMP MTG MS35206-245 96906	EA	2	17
33	57	PAFZZ	PAOZZ	XBFZZ	PAFZZ	D	.008	5340-00-677-5785	CLAMP, CABLE 72-2613-1 30554 NG 06915	EA	2	2
33	58	PAFZZ	PAOZZ	PAGZZ	PAFZZ	D	.008	5310-00-052-3632	NUT, WASHER: CLAMP MTG 69-561-3 30554 511-081800-00 78189	EA	1	54
33	59	PAFZZ	PAOZZ	PAGZZ	PAFZZ	D	.008	5305-00-981-6193	SCREW, MACHINE: CLAMP MTG MS35206-245 96906	EA	1	17
33	60	PAFZZ	PAOZZ	PAGZZ	PAFZZ	D	.008	5340-00-677-5786	CLAMP, CABLE 72-2613-2 30554 N7 06915	EA	1	1
33	61	PAFZZ	PAOZZ	PAGZZ	PAFZZ	D	.008	5310-00-063-7415	NUT, WASHER: WIRING HARNESS MTG 69-561-1 30554 511-041800-00 78139	EA	8	18
33	62	PAFZZ	PAOZZ	PAGZZ	PAFZZ	D	.008	5305-00-889-2998	SCREW, MACHINE: WIRING HARNESS MTG MS35206-216 96906	EA	8	8
33	63	MFFFZ	PBOZZ	AGGG	AFFZZ			6115-00-610-2092	WIRING HARNESS 72-2628 30554 30554-72-2828 326024 MANUFACTURE FROM:	EA	1	1
33	64	PAFZZ	PAOZZ	PAGZZ	PAFZZ	D	.030	5935-00-834-4904	CONNECTOR, RECEPTACLE, P11 MS3106R18-1P 96906	EA	1	2
33	65	PAFZZ	PAOZZ	PAGZZ	PAFZZ	D	.023	5935-00-821-0345	CONNECTOR, RECEPTACLE, J9 MS3102R14S6P 96906	EA	1	1
33	66	PAFZZ	PAOZZ	PAGZZ	PAFZZ	D	.030	5935-00-721-0496	CONNECTOR, RECEPTACLE, J13 69-501-5 30554	EA	1	1
33	67	PZFZZ	PAOZZ	PAGZZ	PAFZZ	D	.050	5940-00-204-8966	TERMINAL, LUG MS25036-102 96906	EA	12	381
33	68	PAFZZ	PAOZZ	PAGZZ	PAFZZ	D	.050	5940-00-113-8184	TERMINAL, LUG MS25036-150 96906	EA	5	13
33	69	PAFZZ	PAOZZ		PAFZZ	D	.050	5940-00-557-1629	TERMINAL, LUG MS25036-149 96906	CZM, CZM	EA	4
33	70	PAFZZ	PAOZZ	PAGZZ	PAFZZ	D	.080	6145-00-573-6602	WIRE, ELECTRICAL M5086/2-18-9 81349	FT	V	232
33	71	PAFZZ	PAOZZ	PAGZZ	PAFZZ	D	.008	5975-00-727-5153	STRAP, CABLE MS3367-4-9 96906	EA	V	189
33	72	XBFZZ	PAOZZ	PAGZZ	PAFZZ	D	.008	5935-00-823-5322	PLUG, END SEAL MS25251-16 96906	EA	11	54
33	73	PAFZZ	PAOZZ		PAFZZ	D	.008	5970-00-954-1622	INSULATION, SLEEVING M23053/5-105-0	FT	2	
33	74	XAFZZ	XC	XBGZZ	XBFZZ				CHASSIS 72-2604 30554 30554-72-2604 36024	EA	1	1

(1) ILLUSTRATION		(2) SMR CODE				(3)		(4)	(5)	(6)	(7)	(8)	
A	B	A	B	C	D	A	B	NATIONAL STOCK NUMBER	DESCRIPTION	USABLE ON CODE	QTY INC IN UNITS	USMC QTY PER EQUIP	
FIG. NO.	ITEM NO.	ARMY	AIR FORCE	NAVY	USMC	SSI	REPL FACTOR	REF NUMBER & MFR CODE		U/M			
33	75	PAFZZ	PAOZZ	PAGZZ	PAFZZ	D	.008	5305-00-989-7434	SCREW,MACHINE:REGULATOR MTG MS35207-263 96906	EA	4	20	
33	76	PAOFF	PAOZZ	PDDGG	PAFFF		.700	6110-00-363-3973	REGULATOR ASSEMBLY 72-2616 30554 30554-72-2616 36024	CLA, CLB CZN, CZM	EA	1	1
33	76	PAOFF	PAOZZ	PDDGG	PAFFF		.700	6110-00-363-3974	REGULATOR ASSEMBLY 72-2611 30554 30554-72-2611 36024	CLC, DGG	EA	1	1
33	77	PAFZZ	PAOZZ	PAGZZ	PAFZZ	D	.008	5310-00-063-7360	NUT, WASHER:HEAT SINK MTG 69-561-2 30554 511-061800-00 78189	EA	4	8	
33	78	PAFZZ	PAOZZ	PAGZZ	PAFZZ	D	.008	5305-00-984-4988	SCREW,MACHINE:HEAT SINK MS35206-228 96906	EA	4	21	
33	79	PAFZZ	PAOZZ	PAHZZ	PAFZZ	D	.010	5310-00-582-5965	WASHER,LOCK:DIODE MTG MS35338-44 96906	EA	2	256	
33	80	PAFZZ	PAOZZ		PAFZZ	D	.008	5970-00-815-1295	INSULATION,SLEEVING M23053/5-106-0 81349	CZN,CZM	FT	V	
33	81	PAFZZ	PAOZZ	PAHZZ	PAFZZ		.040	5961-00-226-8697	DIODE JAN2N689 81349	EA	2	2	
33	82	XBFZZ	XCO	XBGZZ	XBZZ				HEAT SINK 72-2622 30554 30554-72-2622 36024	EA	4	4	
33	83	PAFZZ	PAOZZ	PAGZZ	PAFZZ	D	.008	5310-00-063-7360	NUT AND WASHER:CAPACITOR MTG 69-561-2 30554 5511-061800-00 78189	EA	2	8	
33	84	PAFZZ	PAOZZ	PAGZZ	PAFZZ	D	.008	5305-00-984-4988	SCREW,MACHINE:CAPACITOR MTG MS35206-228 96906	EA	2	21	
33	85	PAFZZ	PAOZZ	PAGZZ	PAFZZ		.050	5910-01-009-0194	CAPACITOR M39022-08-1021 81349	EA	2	2	
33	86	PAFZZ	PAOZZ	PAGZZ	PAFZZ	D	.008	5310-00-063-7360	NUT, WASHER:CAPACITOR MTG 69-561-2 30554 511-061800-00 78189	EA	1	8	
33	87	PAFZZ	PAOZZ	PAGZZ	PAFZZ	D	.008	5305-00-984-4988	SCREW,MACHINE:CAPACITOR MTG MS35206-228 96906	EA	1	21	
33	88	PAFZZ	PAOZZ	PAGZZ	PAFZZ		.050	5910-01-009-0193	CAPACITOR:C13 M39022-08-1025 81349	EA	1	2	
33	89	PAFZZ	PAOZZ	PAGZZ	PAFZZ	D	.008	5310-00-063-7360	NUT, WASHER:CAPACITOR MTG 69-561-2 30554 511-061800-00 78189	CLA, CLB CZN, CZM	EA	1	2
33	90	PAFZZ	PAOZZ	PAGZZ	PAFZZ	D	.008	5305-00-084-4988	SCREW,MACHINE:CAPACITOR MTG MS35206-228 96906	CLA, CLB, CZN, CZM	EA	1	21
33	91	PAFZZ	PAOZZ	PAGZZ	PAFZZ		.050	5910-01-009-0193	CAPACITOR:C12 M39022-08-1025 81349	CLA, CLB, CZN, CZM	EA	1	2
33	92	PAFZZ	PAOZZ	PAGZZ	PAFZZ		.040	5905-01-107-2188	RESISTOR RL42S242GTX 81349	EA	1	1	
33	93	PAFZZ	PAOZZ	PAGZZ	PAFZZ		.040	5950-00-431-7828	RESISTOR RNC55K1501FS	EA	1	1	
33	94	PAFZZ	PAOZZ	PAGZZ	PAFZZ		.040	5905-00-105-7767	RESISTOR RCR07G474JS 81349	EA	1	1	

(1) ILLUSTRATION		(2) SMR CODE				(3)		(4) NATIONAL STOCK NUMBER	(5) DESCRIPTION	(6) USABLE ON CODE	(7) QTY INC IN UNITS	(8) USMC QTY PER EQUIP
A FIG. NO.	B ITEM NO.	A ARMY	B AIR FORCE	C NAVY	D USMC	A SSI	B REPL FACTOR	REF NUMBER & MFR CODE	U/M			
33	95	PAFZZ	PAOZZ	PAGZZ	PAFZZ		.040	5905-00-141-0717 RESISTOR RCR07G473JS 81349	EA	1	1	
33	96	PAFZZ	PAOZZ	PAGZZ	PAFZZ		.050	5910-00-236-8767 CAPACITOR M39003-01-3100 81349	EA	1	1	
33	97	PAFZZ	PAOZZ	PAGZZ	PAFZZ		.040	5905-00-141-0743 RESISTOR, FIXED RCR07G392JS 81349	EA	1	1	
33	98	PAFZZ	PAOZZ	PAGZZ	PAFZZ		.040	5961-00-081-6392 RECTIFIER 69-543 30554 JANIN3611 81349	CLA, CLB CLC, DGG	EA	5	5
33	98	PAFZZ	PAOZZ		PAFZZ		.040	RECTIFIER JANIN4002 81349	CZN, CZM	EA	5	5
33	99	PAFZZ	PAOZZ	PAGZZ	PAFZZ		.040	5905-00-118-4559 RESISTOR, R30 AND R33 RCR07G33JS 81349	EA	2	2	
33	100	PAFZZ	PAOZZ	PAGZZ	PAFZZ		.040	5905-00-432-0421 RESISTOR: R11 RNC55K4991FS 81349	EA	1	1	
33	101	PAFZZ	PAOZZ	PAHZZ	PAFZZ		.040	5961-00-950-6577 DIODE, ZENER JANIN3826A 81349	EA	1	1	
33	102	PAFZZ	PAOZZ	PAGZZ	PAFZZ		.040	5905-00-432-9153 RESISTOR, R6 RNC55K322FS 81349	EA	1	1	
33	103	PAFZZ	PAOZZ	PAGZZ	PAFZZ		.040	5905-00-432-0402 RESISTOR, R10 AND R13 RNC55K2002FS 81349	EA	2	2	
33	104	PAFZZ	PAOZZ	PAGZZ	PAFZZ		.050	5910-00-113-5286 CAPACITOR: C6 M3901402-1356 81349	EA	1	1	
33	105	PAFZZ	PAOZZ	PAGZZ	PAFZZ		.040	5905-00-252-1671 RESISTOR, FIXED RCR07G225JS 81349	EA	1	1	
33	106	PAFZZ	PAOZZ	PAGZZ	PAFZZ		.050	5910-00-113-5445 CAPACITOR: C3 M3901401-1339 81349	EA	1	1	
33	107	PAFZZ	PAOZZ	PAGZZ	PAFZZ		.040	5961-00-949-1440 TRANSISTOR: 03 JAN2N2905A 81349	EA	1	1	
33	108	PAFZZ	PAOZZ	PAGZZ	PAFZZ		.050	5962-00-197-3361 CIRCUIT 72-2624 30554 M38510/10201BIC 81349	EA	1	1	
33	109	PAFZZ	PAOZZ	PAGZZ	PAFZZ		.040	5905-00-111-4858 RESISTOR RCR20G471JS 81349	EA	1	1	
33	110	PAFZZ	PAOZZ	PAGZZ	PAFZZ		.040	5905-00-250-5986 RESISTOR: R7 AND R15 RNC55K4992FS 81349	EA	2	2	
33	111	PAFZZ	PAOZZ	PAHZZ	PAFZZ		.040	5961-00-490-0318 TRANSISTOR JAN2N4948 81349	EA	1	1	
33	112	PAFZZ	PAOZZ	PAGZZ	PAFZZ		.040	5961-00-951-8757 TRANSISTOR: 05 JAN2N222A 81349	CLA, CLB CZN, CZM	EA	1	1
33	112	PAFZZ	PAOZZ	PAHZZ	PAFZZ		.040	5961-00-951-8757 TRANSISTOR: 08 AND 06 JAN2N222A 81349	CLC, DGG	EA	2	1
33	113	PAFZZ	PAOZZ	PAHZZ	PAFZZ		.040	5961-00-892-0919 DIODE, ZENER JANIN3031B 81349	EA	1	1	
33	114	PAFZZ	PAOZZ	PAGZZ	PAFZZ		.050	5910-00-127-3082 CAPACITOR M39022/01 81349	CLA, CLB CZN, CZM	EA	1	1

(1) ILLUSTRATION A	(2) SMR CODE A	(3) B	(4) NATIONAL STOCK NUMBER	(5) DESCRIPTION	(6) USABLE ON CODE	(7) QTY INC IN UNITS	(8) USMC QTY PER EQUIP					
								A	B	C	D	A
33	114	PAFZZ	PAOZZ	PAGZZ	PAFZZ	.050	5910-01-068-6334	CAPACITOR M39022-01-1038 81349	CLC, DGG	EA	1	1
33	115	PAFZZ	PAOZZ	PAGZZ	PAFZZ	.040	5905-00-785-6082	RESISTOR:R4 AND RS RCR42G751JS 81349		EA	2	2
33	116	PAFZZ	PAOZZ	PAGZZ	PAFZZ	.040	5905-00-105-7764	RESISTOR, FIXED RCRF07G222JS 81349	CLC, DGG	EA	1	2
33	117	PAFZZ	PAOZZ	PAGZZ	PAFZZ	.040	5905-00-141-1183	RESISTOR, FIXED RCR07G101JS 81349	CLC, DGG	EA	2	2
33	118	PAFZZ	PAOZZ	PAGZZ	PAFZZ	.040	5910-00-254-2790	CAPACITOR M39022/1-1541 81349	CLC, DGG	EA	1	2
33	119	PAFZZ	PAOZZ	PAHZZ	PAFZZ	.040	5961-00-958-5391	DIODE:CR7 AND CR8 JAN1N4247 81349		EA	2	2
33	120	PAFZZ	PAOZZ	PAGZZ	PAFZZ	.040	5905-00-107-0656	RESISTOR, FIXED:R18 AND 19 RCR07G100JS 81349		EA	2	2
33	121	PAFZZ	PAOZZ	PAGZZ	PAFZZ	.040	5905-00-113-4861	RESISTOR RCR07G390JS 81349		EA	1	1
33	122	PAFRZZ	PAOZZ	PAGZZ	PAFZZ	.040	5910-00-113-5475	CAPACITOR CSR13E106ML 81349	CLC, DGG	EA	1	1
33	123	PAFZZ	PAOZZ	PAHZZ	PAFZZ	.040	5961-00-826-9048	DIODE, ZENER JAN1N30208 81349	CLC, DGG	EA	1	1
33	124	PAFZZ	PAOZZ	PAGZZ	PAFZZ	.040	5905-00-173-1119	RESISTOR RCR42G151JS 81349		EA	1	1
33	125	PAFZZ	PAOZZ	PAGZZ	PAFZZ	.050		CAPACITOR M39022-01-1142 81349		EA	1	1
33	126	PAFZZ	PAOZZ	XBGZZ	PAFZZ	.050	5940-00-159-0237	TERMINAL, LUG 72-2623 30554 486-74D 86577		EA	11	11
33	127	PAFZZ	PAOZZ	PAHZZ	PAFZZ	.040	5961-00-914-9740	DIODE:CR12, CR13, CR14, CR15, CR18 CR19, CR20, CR21, CR22, CR23 JAN1N4246 81349		EA	10	10
33	128	PAFZZ	PAOZZ	PAGZZ	PAFZZ	.040	5905-00-121-9861	RESISTOR RCR32G102JS 81349		EA	1	1
33	129	PAFZZ	PAOZZ	PAGZZ	PAFZZ	.040	5905-00-106-9346	RESISTOR RCR32G103JS 81349	CLC, DGG	EA	1	1
33	130	PAFZZ	PAOZZ	PAGZZ	PAFZZ	.040	5905-00-770-5290	RESISTOR RLR32C183JM 81349	CLA, CLB, CZN, CZM	EA	1	1
33	130	PAFZZ	PAOZZ	PAGZZ	PAFZZ	.040	5905-00-172-4646	RESISTOR RLR32C510LGR 81349	CLC, DGG	EA	1	1
33	131	PAFZZ	PAOZZ	PAGZZ	PAFZZ	.040	5905-00-106-1245	RESISTOR RCR32G272JS 81349		EA	1	1
33	132	PAFZZ	PAOZZ	PAGZZ	PAFZZ	.050	5910-00-007-2004	CAPACITRO:C9 AND C10 M39003-01-3088 81349	CLA, CLB CZN, CZM	EA	2	2
33	132	PAFZZ	PAOZZ	PAGZZ	PAFZZ	.050	5910-00-007-2004	CAPACITOR:C9 M39003-01-3088 81349	CLC, DGG	EA	1	2
33	133	PAFZZ	PAOZZ	PAGZZ	PAFZZ	.040	5905-00-481-8904	RESISTOR RLR42C512GM 81349		EA	1	1

(1) ILLUSTRATION A	(2) SMR CODE A	B	C	D	(3) A	B	(4) NATIONAL STOCK NUMBER	(5) DESCRIPTION REF NUMBER & MFR CODE	USABLE ON CODE	(6) U/M	(7) QTY INC IN UNITS	(8) USMC QTY PER EQUIP	
													FIG. NO.
33	134	PAFZZ	PAOZZ	PAGZZ	PAFZZ	.040	5905-00-060-3862	RESISTOR RLR32C1002GR 81349		EA	1	1	
33	135	PAFZZ	PAOZZ	PAGZZ	PAFZZ	.040	5905-00-141-1183	RESISTOR, FIXED RCR07G101JS 81349	CLA, CLB CZN, CZM	EA	1	1	
33	136	PAFZZ	PAOZZ	PAGZZ	PAFZZ	.040	5905-00-141-1183	RESISTOR, FIXED RCR07G101JS 81349	CLC, DGG	EA	2	2	
33	137	PAFZZ	PAOZZ	PAGZZ	PAFZZ	.050	5910-00-254-8164	CAPACITOR C5R13G684MC 81349	CLA, CLB	EA	1	1	
33	138	XBFZZ	PAOZZ	XBGZZ	PAFZZ			RIVET, BLIND M24243-1D404 81349		EA	4	4	
33	139	XAFZZ	XA	XBGZZ	XAFZZ			BOARD: PC 72-2602 30554 30554-72-2602 36024	CLA, CLB CZA, CZM	EA	1	1	
33	139	XAFZZ	XA	XBGZZ	XAFZZ			BOARD: PC 72-2603 30554	CLC, DGG	EA	1	1	
33	140	XBFZZ	MOO	XBGZZ	XBFZZ			BRACKET MOUNTING 72-2610 30554 30554-72-2610 36024		EA	2	2	
33	141	PAFZZ	PAOZZ	PAGZZ	PAFZZ	D	.008	5310-00-063-7415	NUT, WASHER: WIRING HARNESS MTG 69-561-1 30554 511-041800-00 78189		EA	4	18
33	142	PAFZZ	PAOZZ	PAGZZ	PAFZZ	D	.008	5305-00-889-2998	SCREW MACHINE MS35206-106 96906		EA	4	16
33	143	MFFPZ	AOO	AGGGG	APFZZ			WIRING HARNESS 72-2627 30554 30554-72-2627 36024		EA	1	1	
33	144	PAFZZ	PAOZZ	PAGZZ	PAFZZ	D	.023	5935-00-813-4364	CONNECTOR 72-2627 30554 MS3102R18-1S 96906		EA	1	1
33	145	PAFZZ	PAOZZ	PAGZZ	PAFZZ	D	.008	5975-00-727-5153	STRAP, CABLE MS3367-4-9 96906		EA	15	189
33	146	PAFZZ	PAOZZ	PAGZZ	PAFZZ	D	.080	6145-00-578-6602	WIRE, ELECTRICAL M5086/2-18-9 81349		FT	11	232
33	147	PAFZZ	PAOZZ		PAFZZ	D	.008	5970-00-954-1622	INSULATION, SLEEVING M23053/5-105-0 81349	CZN, CZM	FT	1	
33	148	APFZZ	PAOZZ	PAGZZ	PAGZZ	D	.050	5940-00-204-8966	TERMINAL, LUG MS2506-102 96909		EA	4	381
33		PAFZZ	PAOZ	XBGZZ	PAFZZ	D	.008	5970-00-954-1622	INSULATION M23053/5-105-0 81349		FT	1	
33		PAFZZ	PAOZZ	XBGZZ	PAFZZ	D	.080	6145-00-577-3420	WIRE QQW343TYPES24AWG 81349		FT	1	

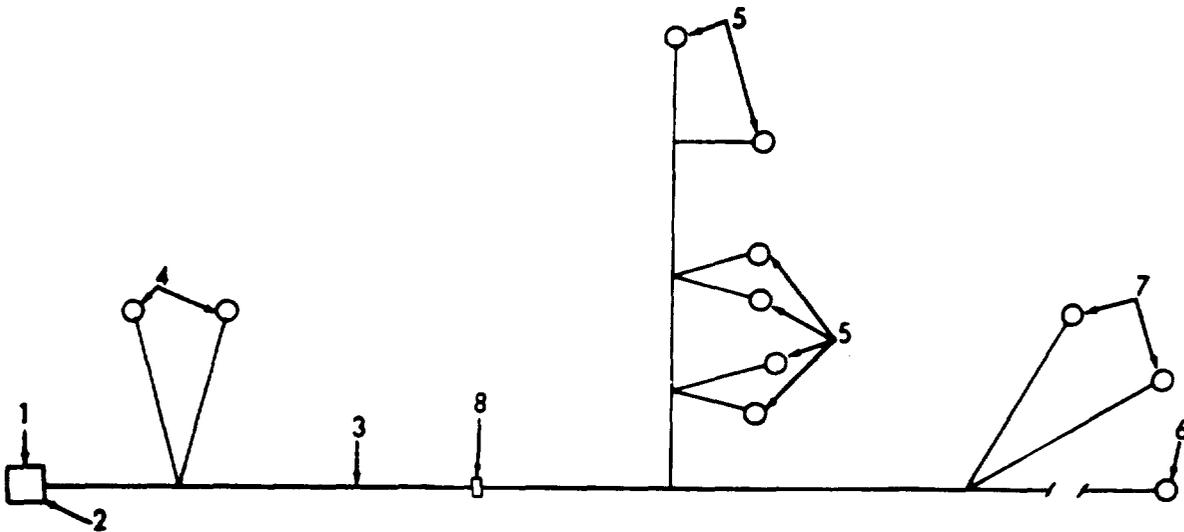

Figure 34. Exciter control wiring harness.

TM9-6115-465-24P
 TO 35C2-3-446-4
 NAVFAC P-8-625-24P
 SL-4-06858B/06859D

(1) ILLUSTRATION		(2) SMR CODE				(3)		(4) NATIONAL STOCK NUMBER	(5) DESCRIPTION	(6) USABLE ON CODE	(7) QTY INC IN UNITS	(8) USMC QTY PER EQUIP
A FIG. NO.	B ITEM NO.	A ARMY	B AIR FORCE	C NAVY	D USMC	A SSI	B REPL FACTOR	REF NUMBER & MFR CODE	U/M			
34		MFFFF	AOO	AGGGG	PAFZZ			WIRING HARNESS:EXCITER CONTROL 72-2288 30554 30554-72-2288 36024 MANUFACTURE FROM:	EA	1	1	
34	1	PAFZZ	PAOZZ	XBGZZ	PAFZZ	D	.023	5935-00-814-9781 CONNECTOR,PLUG MS3106R22-14S 96906	EA	1	1	
34	2	XBFZZ	PAOZZ	PAGZZ	PAFZZ	D	.008	5935-00-823-5322 PLUG,END SEAL MS25251-16 96906	EA	8	54	
34	3	PAFZZ	PAOZZ	PAGZZ	PAFZZ	D	.080	6145-00-578-6605 WIRE,ELECTRICAL M5086-2-16-9 81349 M5086-2-16-9 81349	FT	V	490	
34	4	PAFZZ	PAOZ	PAOZZ	PAFZZ	D	.050	5940-00-143-4774 TERMINAL,LUG MS25036-153 96906	EA	2	25	
34	5	PAFZZ	PAOZZ	PAGZZ	PAFZZ	D	.050	5940-00-143-4780 TERMINAL,LUG MS25036-108 96906	EA	6	15	
34	6	PAFZZ	PAOZZ	PAGZZ	PAFZZ	D	.050	5940-00-230-0515 TERMINAL,LUG MS25036-154 96906	EA	1	4	
34	7	PAFZZ	PAOZZ	PAGZZ	PAFZZ	D	.050	5940-00-143-4793 TERMINAL,LUG MS25036-110 96906	EA	2	11	
34	8	PAFZZ	PAOZZ	PAGZZ	PAFZZ	D	.008	5975-00-727-5153 STRAP,CABLE MS3367-4-9 96906	EA	V	189	

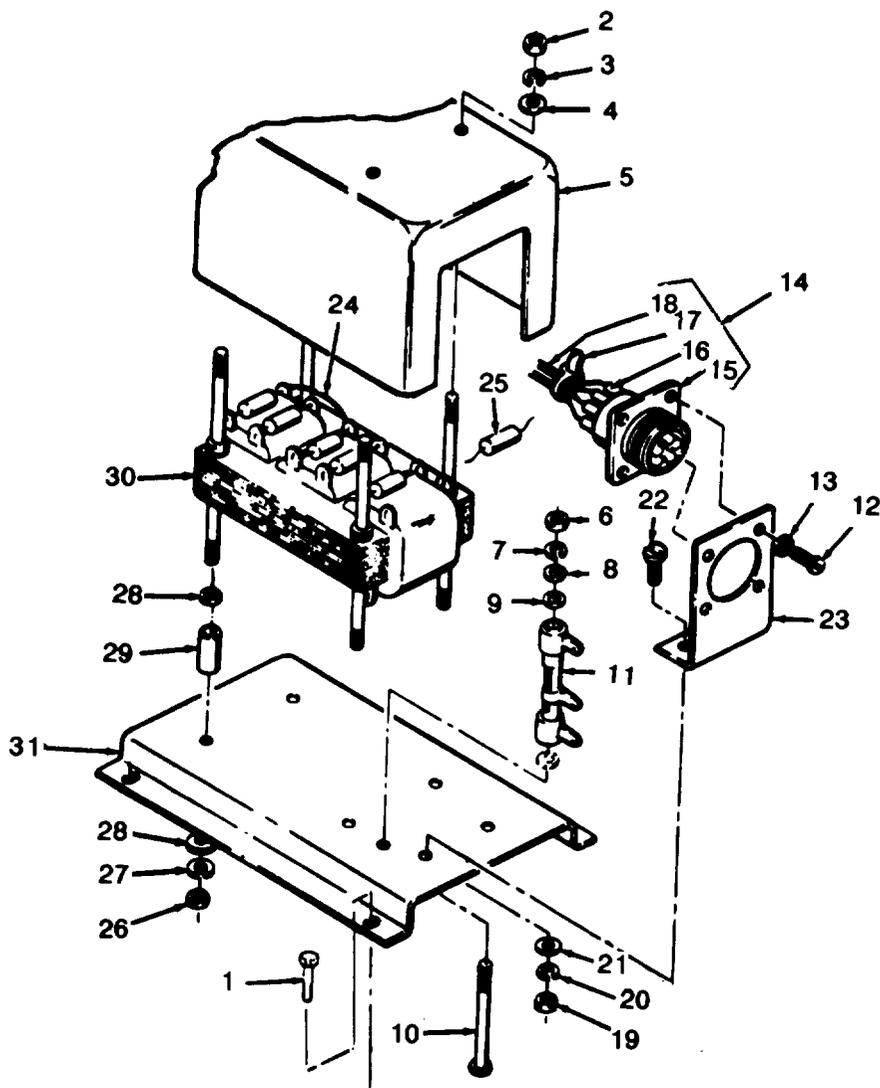

Figure 35. Load measuring unit.

(1) ILLUSTRATION A FIG. NO.	(2) SMR CODE B ITEM NO.	(3)				(4) NATIONAL STOCK NUMBER	(5) DESCRIPTION REF NUMBER & MFR CODE	(6) USABLE ON CODE U/M	(7) QTY INC IN UNITS	(8) USMC QTY PER EQUIP		
		A	B	C	D							
35	1	PAOZZ	PAOZZ	PAHZZ	PAFZZ	D	.080	5305-00-036-6977	SCREW ASSEMBLED WASHER:LOAD MEASURING UNIT MTG 69-662-33 30554 P15121-33 45722	EA	4	16
35		PAOFF	PAOFF	PAHHH	PAFFF		.700	6115-00-183-5333	LOAD MEASURING UNIT 69-785 30554	EA	1	1
35	2	PAFZZ	PAOZZ	PAGZZ	PAFZZ	D	.008	5310-00-934-9747	NUT,PLAIN,HEXAGON:COVER MTG MS35649-262 96906	EA	4	36
35	3	PAFZZ	PAOZZ	PAGZZ	PAFZZ	D	.010	5310-00-045-4007	WASHER,LOCK:COVER MTG MS35338-41 96906	EA	4	41
35	4	PAFZZ	PAOZZ	PAGZZ	PAFZZ	D	.010	5310-00-082-1404	WASHER,FLAT:COVER MTG MS27183-6 96906	EA	4	14
35	5	XBFZZ	XB	XBHZZ	XBFZZ				COVER 69-503 30554	EA	1	1
35	6	PAFZZ	PAOZZ	PAGZZ	PAFZZ	D	.008	5310-00-934-9757	NUT,PLAIN,HEXAGON:RESISTOR MTG MS35649-282 96906	EA	1	1
35	7	PAFZZ	PAOZZ	PAGZZ	PAFZZ	D	.020	5310-00-045-3299	WASHER,LOCK:RESISTOR MTG MS35338-42 96906	EA	1	9
35	8	PAFZZ	PAOZZ	PAGZZ	PAFZZ	D	.010	5310-00-765-3197	WASHER,FLAT:RESISTOR MTG MS27183-41 96906	EA	1	1
35	9	PAFZZ	PAOZZ	PAGZZ	PAFZZ	D	.010	5310-00-991-2949	WASHER,FLAT:RESISTOR MTG NAS549P8 80205	EA	2	2
35	10	PAFZZ	PAOZZ	PAGZZ	PAFZZ	D	.008	5305-00-069-5122	SCREW,MACHINE:RESISTOR MTG MS35265-55 96906	EA	1	1
35	11	PAFZZ	PAOZZ	PAGZZ	PAFZZ		.050	5905-00-642-5025	RESISTOR,ADJUSTABLE 69-505 30554 10A500 63743	EA	1	1
35	12	PAFZZ	PAOZZ	PAGZZ	PAFZZ	D	.008	5305-00-622-9475	SCREW,MACHINE:WIRING HARNESS MTG MS35265-41 96906	EA	4	4
35	13	PAFZZ	PAOZZ	PAGZZ	PAFZZ	D	.010	5310-00-045-3299	WASHER,LOCK:WIRING HARNESS MTG MS35338-42 96906	EA	4	9
35	14	MFFFZ	MOO	AGGGG	AFFZZ				WIRING HARNESS 69-511 30554 MANUFACTURE FROM:	EA	1	1
35	15	PAFZZ	PAOZZ	PAGZZ	PAFZZ	D	.030	5935-00-367-7625	CONNECTOR,RECEPTACLE 69-502-2 30554	EA	1	1
35	16	XBFZZ	PAOZZ	XBGZZ	XBFZZ	D	.008	5970-00-954-1622	SLEEVING,INSULATION M23053/5-105-0 81349	FT	1	V
35	17	PAFZZ	PAOZZ	PAGZZ	PAFZZ	D	.008	5975-00-156-3253	STRAP,CABLE MS3367-2-9 96906	EA	1	1
35	18	PAFZZ	PAOZZ	XBGZZ	PAFZZ	D	.080	5145-00-643-0647	WIRE,ELECTRICAL M16878-2-20-9 81349	FT	V	9
35	19	PAFZZ	PAOZZ	PAGZZ	PAFZZ	D	.008	5310-00-934-9757	NUT,PLAIN,HEXAGON:HARNESS BRACKET MTG MS35649-282 96906	EA	2	36
35	20	PAFZZ	PAOZZ	PAGZZ	PAFZZ	D	.010	5310-00-045-4007	WASHER,LOCK:HARNESS BRACKET MTG MS35338-41 96906	EA	2	41
35	21	PAFZZ	PAOZZ	PAGZZ	PAFZZ	D	.010	5310-00-082-1404	WASHER,FLAT:HARNESS BRACKET MS27183-6 96906	EA	2	14

(1) ILLUSTRATION		(2) SMR CODE				(3)		(4) NATIONAL STOCK NUMBER	(5) DESCRIPTION	(6) USABLE ON CODE	(7) QTY INC IN UNITS	(8) USMC QTY PER EQUIP
A FIG. NO.	B ITEM NO.	A ARMY	B AIR FORCE	C NAVY	D USMC	A SSI	B REPL FACTOR	REF NUMBER & MFR CODE	U/M			
35	22	PAFZZ	PAOZZ	PAGZZ	PAFZZ	D	.008	5305-00-582-5807 SCREW,MACHINE:HARNESS BRACKET MTG MS35165-28 96906	EA	2	2	
35	23	XBFZZ	XB	XBHZZ	XBFZZ			BRACKET:WIRING HARNESS MTG 69-504 30554	EA	1	1	
35	24	PAFZZ	PAOZZ	XBGZZ	PAFZZ	D	.080	6145-00-643-0647 WIRE,ELECTRIC M16878-2-20-9 81349	FT	V	9	
35	25	PAFZZ	PAOZZ	PAGZZ	PAFZZ		.050	5961-00-998-6947 RECTIFIER 69-512 30554 IN4385 81349	EA	6	6	
35	26	PAFZZ	PAOZZ	PAGZZ	PAFZZ	D	.008	5310-00-934-9747 NUT,PLAIN,HEXAGON:TRANSFORMER MTG MS35649-262 96906	EA	4	36	
35	27	PAFZZ	PAOZZ	PAGZZ	PAFZZ	D	.010	5310-00-045-4007 WASHER,LOCK:TRANSFORMER MTG MS35338-41 96906	EA	4	41	
35	28	PAFZZ	PAOZZ	PAGZZ	PAFZZ	D	.010	5310-00-082-1404 WASHER,FLAT:TRANSFORMER MTG MS27183-6 96906	EA	8	14	
35	29	XBFZZ	PAOZZ	XBHZZ	XBFZZ			TUBE,MOLDED MILP79FORMTMTYPEPB 81349	EA	4	4	
35	30	PAFZZ	PAOZZ	PAGZZ	PAFZZ	D	.040	5950-00-327-9625 TRANSFORMER 69-508 30554	EA	1	1	
35	31	XBFZZ	XB	XBGZZ	XBFZZ			PLATE,MOUNTING 69-507 30554	EA	1	1	
35	32	XBFZZ	XC	XCGZZ	MDOZZ			PLATE,IDENTIFICATION 69-506 30554	EA	1	1	

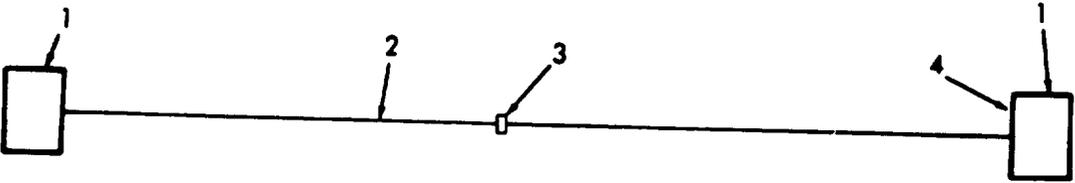

Figure 36. Load measuring unit to tactical relay assembly wiring harness.

TM9-6115-465-24P
 TO 35C2-3-446-4
 NAVFAC P-8-625-24P
 SL-4-06858B/06859D

(1) ILLUSTRATION A	(2) SMR CODE A	B	C	D	(3) A	B	(4) NATIONAL STOCK NUMBER	(5) DESCRIPTION REF NUMBER & MFR CODE	USABLE ON CODE	(6) U/M	(7) QTY INC IN UNITS	(8) USMC QTY PER EQUIP
FIG. NO.	ITEM NO.	ARMY	AIR FORCE	NAVY	USMC	SSI						
36		MFOFF	AFOZZ	AGGGG	AFFZZ			WIRING HARNESS: LOAD MEASURING UNIT TO TACTICAL RELAY 30554-2234 30554 30554-72-2234 36024 MANUFACTURE FROM:		EA	1	1
36	1	PAFZZ	PAOZZ	PAGZZ	PAFZZ	D	.023	5935-00-725-8233		EA	2	3
36	2	PAFZZ	PAOZZ	PAGZZ	PAFZZ	D	.080	6145-00-578-6605		FT	V	490
36	3	PAFZZ	PAOZZ	PAGZZ	PAFZZ	D	.008	5975-00-111-3208		EA	V	232
36	4	XBFZZ	PAOZZ	PAGZZ	PAFZZ	D	.008	5935-00-823-5322		EA	10	54

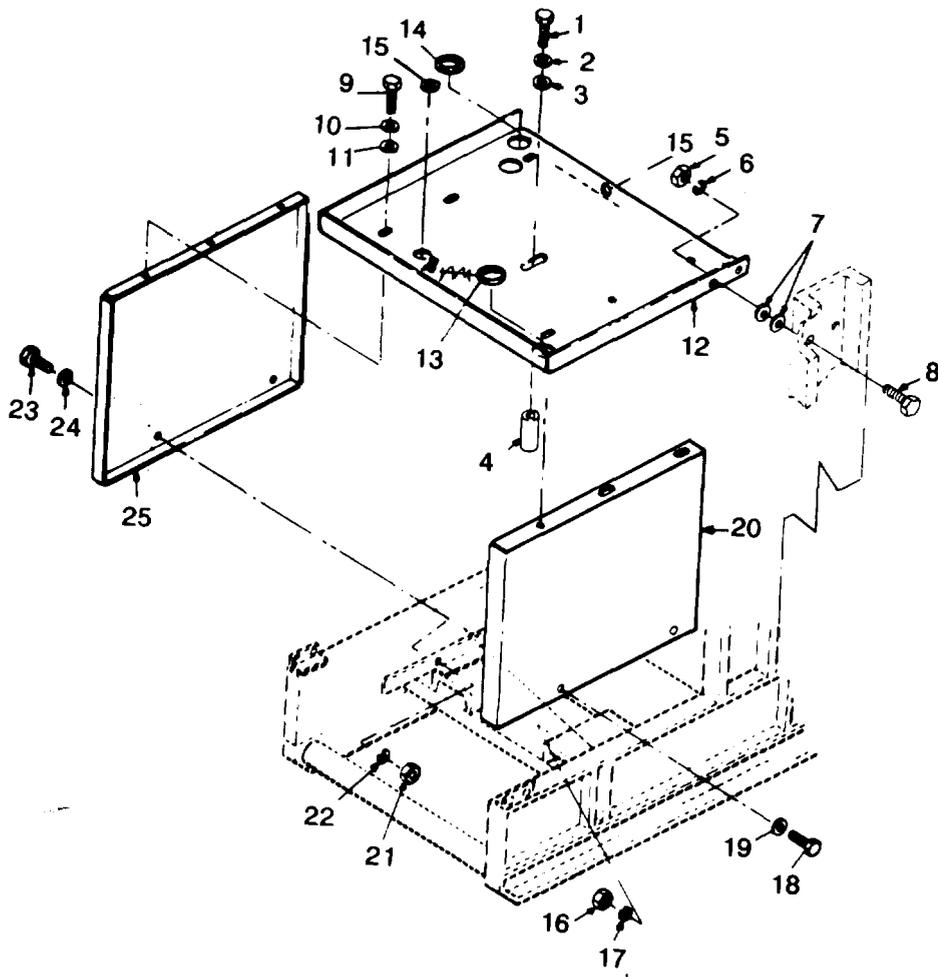

Figure 37. Relay tables.

(1) ILLUSTRATION A FIG. NO.	(2) SMR CODE B ITEM NO.	(3)					(4) NATIONAL STOCK NUMBER	(5) DESCRIPTION REF NUMBER & MFR CODE	(6) USABLE ON CODE U/M	(7) QTY INC IN UNITS	(8) USMC QTY PER EQUIP
		A ARMY	B AIR FORCE	C NAVY	D USMC	A SSI					
37	1	PAFZZ	PAOZZ	PAGZZ	PAFZZ	D	.008 5305-00-071-2239	SCREW,CAP,HEXAGON HEAD: TABLE TOP MTG MS90725-115 96906	CLA,CLB CLC,DGG	EA	1 1
37	2	PAFZZ	PAOZZ	PAGZZ	PAFZZ	D	.010 5310-00-584-5272	WASHER,LOCK:TABLE TOP MTG MS35338-48 96906	CLA,CLB CLC,DGG	EA	1 1
37	3	PAFZZ	PAOZZ	PAFGZ	PAFZZ	D	.010 5310-00-809-5997	WASHER,FLAT:TABLE TOP MTG MS27183-17 96906	CLA,CLB CLC,DGG	EA	1 1
37	4	XBFZZ	MOO	XBGZ/XBFZZ				SPACER, TABLE:TOP 72-2099-1 30554 30554-72-2099-1 36024	CLA,CLB CLC,DGG	EA	1 1
37	5	PAFZZ	PAOZZ		PAFZZ	D	.008 5310-00-732-0558	NUT,PLAIN,HEXAGON:TABLE TOP MTG MS51967-8 96906	CZN,CZM	EA	2
37	6	PAFZZ	PAOZZ		PAFZZ	D	.010 5310-00-637-9541	WASHER,LOCK:TABLE TOP MTG MS35338-46 96906	CZN,CZM	EA	2
37	7	PAFZZ	PAOZZ		PAFZZ	D	.010 5310-00-080-6004	WASHER,FLAT TABLE TOP MTG MS27183-14 96906	CZN,CZM	EA	4
37	8	PAFZZ	PAOZZ		PAFZZ	D	.008 5305-00-269-3211	SCREW,CAP,HEXAGON HEAD: TABLE TOP MTG MS90725-60 96906	CZN,CZM	EA	2
37	9	PAFZZ	PAOZZ	PAGZZ	PAFZZ	D	.008 5306-00-225-8497	BOLT,MACHINE:TABLE TOP MTG MS90725-32 96906		EA	6 44
37	10	PAFZZ	PAOZZ	PAGZZ	PAFZZ	D	.010 5310-00-407-9566	WASHER,LOCK:TABLE TOP MTG MS35338-45 96906		EA	6 26
37	11	PAFZZ	PAOZZ	PAGZZ	PAFZZ	D	.010 5310-00-081-4219	WASHER,FLAT:TABLE TOP MTG MS27183-12 96906		EA	6 30
37	12	XBFZZ	XB	XBGZZ	XBFZZ			RELAY TABLE, TOP 72-2041 30554 30554-72-2041 36024		EA	1 1
37	13	MFFZZ	MOO	MFFZZ	MFFZZ	D	.050	GROMMET, PLASTIC MANUFACTURE FROM:	CLA,CLB CLC,CZN CZM	EA	1 3
37		PAFZZ	PAOZZ	PAFZZ	PAFZZ			5325-00-027-0322 PLASTIC MS21266-3N 96906 (10.210 IN. REQUIRED)	CLA,CLB CLC,CZN CZM	EA	1
37	13	PAFZZ	PAOZZ		PAFZZ			5325-00-582-3601 GROMMET MS35489-38 96906	DGG	EA	1
37	14	MFFZZ	MOO	MFFZZ	MFFZZ			GROMMET, PLASTIC MANUFACTURE FROM:	CLA,CLB CLC,CZN CZM	EA	V
		PAFZZ	PAOZZ	PAFZZ	PAFZZ	D	.060	5325-00-027-0322 PLASTIC MS21266-3N 96906 (9.420 IN. REQUIRED)	CLA,CLB CLC,CZN CZM	EA	1
37	15	PAFZZ	PAOZZ		PAFZZ			5305-00-582-3601 GROMMET,RUBBER MS35489-38 96906		EA	2
37	16	PAFZZ	PAOZZ	PAGZZ	PAFZZ	X	.008 5310-00-880-7744	NUT,PLAIN,HEXAGON:PANEL MTG MS51967-5 96906		EA	2 24
37	17	PAFZZ	PAOZZ	PAGZZ	PAFZZ	D	.010 5310-00-407-9566	WASHER,LOCK:PANEL MTG MS35338-45 96906		EA	2 26

(1) ILLUSTRATION		(2) SMR CODE				(3)		(4) NATIONAL STOCK NUMBER	(5) DESCRIPTION	(6) USABLE ON CODE	(7) QTY INC IN UNITS	(8) USMC QTY PER EQUIP
A FIG. NO.	B ITEM NO.	A ARMY	B AIR FORCE	C NAVY	D USMC	A SSI	B REPL FACTOR	REF NUMBER & MFR CODE	U/M			
37	18	PAFZZ	PAOZZ	PAGZZ	PAFZZ	D	.008	5306-00-225-8497	BOLT,MACHINE MS90725-32 96906	EA	2 44	
37	19	PAFZZ	PAOZZ	PAGZZ	PAFZZ	D	.010	5310-00-081-4219	WASHER,FLAT:PANEL MTG MS27183-12 96906	EA	2 30	
37	20	XBFZZ	XBOZZ	XBGZZ	XBFZZ				PANEL,RELAY 72-2040 30554 30554-72-2040 36024	EA	1 1	
37	21	PAFZZ	PAOZZ	PAGZZ	PAFZZ	D	.008	5310-00-880-7744	NUT,PLAIN,HEXAGON:PANEL MTG MS51967-5 96906	EA	2 24	
37	22	PAFZZ	PAOZZ	PAGZZ	PAFZZ	D	.010	5310-00-407-9566	WASHER,LOCK:PANEL MTG MS35338-45 96906	EA	2 26	
37	23	PAFZZ	PAOZZ	PAGZZ	PAFZZ	D	.008	5306-00-225-8497	BOLT,MACHINE:PANEL MTG MS90725-32 96906	EA	2 44	
37	24	PAFZZ	PAOZZ	PAGZZ	PAFZZ	D	.010	5310-00-081-4219	WASHER,FLAT:PANEL MTG MS27183-12 96906	EA	2 30	
37	25	XBFZZ	XB	XBGZZ	XBFZZ				PANEL,RELAY 72-2039 30554 30554-72-2039 36024	EA	1 1	

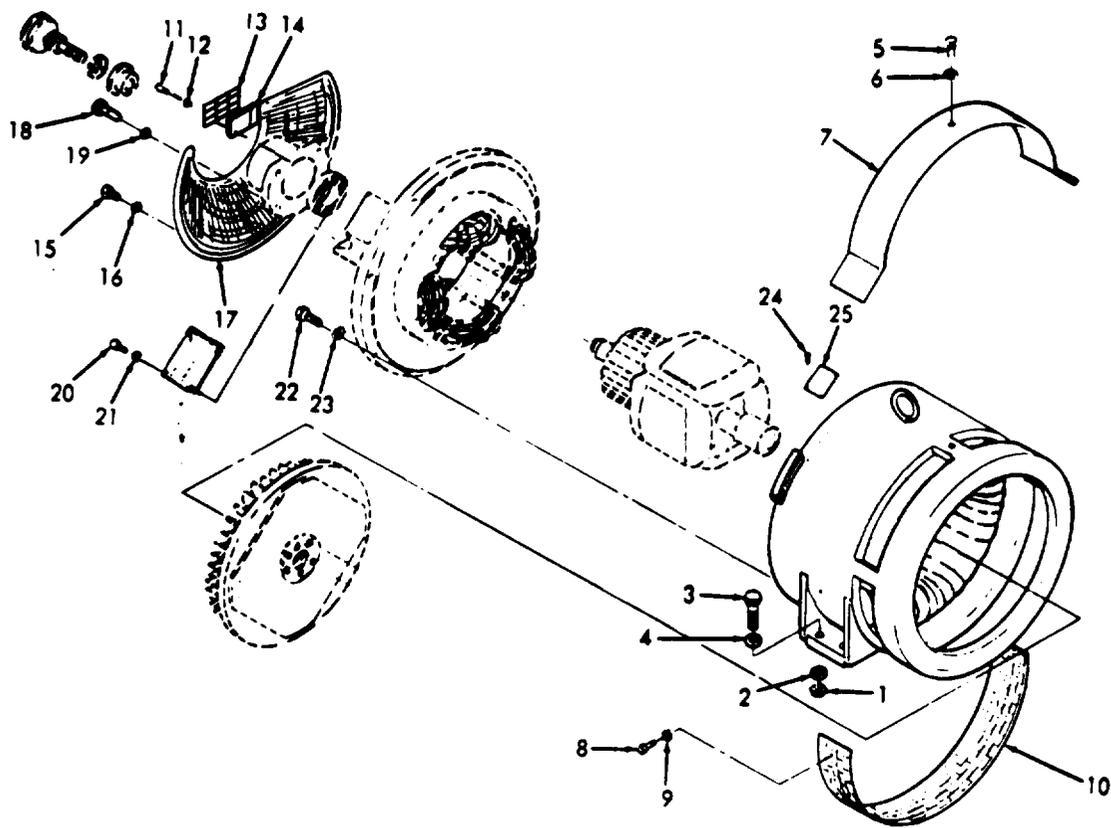

Figure 38. Generator assembly.

**TM 9-6115-465-24P
TO 35C2-3-446-4
NAVFAC P-8-625-24P
SL-4-06858B/06859D**

(1) ILLUS- TRATION		(2) SMR CODE				(3)		(4)	(5) DESCRIPTION		(6)	(7)	(8)
a	b	a	b	c	d	a	b	NATIONAL STOCK NUMBER	REF NUMBER & MFR CODE	USABLE ON CODE	U/M	QTY INC IN UNIT	USMC QTY PER EQUIP
FIG NO.	ITEM NO.	ARMY	AIR FORCE	NAVY	USMC	SSI	REPL FACTOR						
									GROUP 14 -GENERATOR ASSEMBLY				
38	1	PAFZZ	PAOZZ	PAGZZ	PAFZZ	D	.008	5310-00-763-8921	NUT, PLAIN, HEXAGON: GENERATOR MTG MS51967-23 96906		EA	4	4
38	2	PAFZZ	PAOZZ	PAGZZ	PAFZZ	D	.010	5310-00-407-9566	WASHER, LOCK: GENERATOR MTG MS35338-51 96906		EA	4	4
38	3	PAFZZ	PAOZZ	PAGZZ	PAFZZ	D	.006	5306-00-958-8995	BOLT, MACHINE: GENERATOR MTG MS90725-188 96906		EA	4	4
38	4	PAFZZ	PAOZZ	PAGZZ	PAFZZ	D	.010	5310-00-809-8553	WASHER, FLAT: GENERATOR MTG MS27183 96906		EA	4	4
38		PBFFH	PBOZZ	PDHHD	PAFFH	-	.175	6115-00-368-8200	GENERATOR ASSEMBLY 72-2500 30554 107D240G01 19899	CLA, CLB CZN, CZM	EA	1	1
38		PBFFH	PBOZZ	PDHHD	PAFFH	-	.175	6115-00-433-6726	GENERATOR ASSEMBLY 72-2550 30554 107D274GOI 19899	CLC, DGG	EA	1	1
38	5	PAFZZ	PAOZZ	PAGZZ	PAHZZ	D	.008	5305-00-068-0500	SCREW, CAPHEXAGON HEAD: COVER MTG MS90726-3 96906		EA	3	179
38	6	PAFZZ	PAOZZ	PAGZZ	PAHZZ	D	.020	5310-00-889-2528	WASHER, LOCK: COVER MTG MS35333-40 96906		EA	3	12
38	7	XBFZZ	XC	XBHZZ	XBHZZ	-	-		COVER, REAR DIFFERENTIAL 1588145F01 19899 72-2435 30554		EA	1	1
38	8	PAFZZ	PAOZZ	PAGZZ	PAHZZ	D	.008	5305-00-068-0500	SCREW, CAPHEXAGON HEAD: SCREEN MTG MS90725-3 96906		EA	2	179
38	9	PAFZZ	PAOZZ	PAGZZ	PAHZZ	D	.010	5310-00-889-2528	WASHER, LOCK: SCREEN MTG MS35333-40 96906		EA	2	12
38	10	XBFZZ	XO	XBHZZ	XBHZZ	-	-		SCREEN GUARD 1588149F01 19899 72-2457 30554		EA	1	1
38	11	PAFZZ	PAOZZ	PAGZZ	PAHZZ	D	.008	5305-00-068-0500	SCREW, CAP, HEXAGON HEAD: SCREEN COVER MTG MS90725-3 96906		EA	1	179
38	12	PAFZZ	PAOZZ	PAGZZ	PAHZZ	D	.010	5310-00-889-2528	WASHER, LOCK: SCREEN COVER MTG MS35333-40		EA	2	12
38	13	XBFZZ	XC	XBHZZ	XBHZZ	-	-		COVER, SCREEN 72-2448 30554 1598079 19899		EA	1	1
38	14	XBFZZ	XC	XBHZZ	XBHZZ	-	-		GASKET, DIODE COVER 72-2458 30554 1598078 36024		EA	1	1
38	15	PAFZZ	PAOZZ	PAGZZ	PAHZZ	D	.008	5305-00-068-0500	SCREEN, CAP, HEXAGON HEAD: GUARD MTG SCREW MS90725-3 96906		EA	4	179
38	16	PAFZZ	PAOZZ	PAGZZ	PAHZZ	D	.080	5310-00-889-2528	WASHER, LOCK: GUARD MTG MS35333-40 96906		EA	4	179
38	17	XBFZZ	XC	XBHZZ	XBHZZ	-	-		GUARD, BRACKET 125C1277FO1 19899 72-2449 30554		EA	1	1

TM9-6115-465-24P
 TO 35C2-3-446-4
 NAVFAC P-8-625-24P
 SL-4-06858B/06859D

(1) ILLUSTRATION		(2) SMR CODE				(3)		(4) NATIONAL STOCK NUMBER	(5) DESCRIPTION	(6) USABLE ON CODE	(7) QTY INC IN UNITS	(8) USMC QTY PER EQUIP
A FIG. NO.	B ITEM NO.	A ARMY	B AIR FORCE	C NAVY	D USMC	A SSI	B REPL FACTOR	REF NUMBER & MFR CODE	U/M			
38	18	PAFZZ	PAOZZ	PAGZZ	PAHZZ	D	.008	5305-00-269-3211 SCREEN,CAP,HEXAGON HEAD:BEARING KIT MTG MS90725-60 96906	EA	4	10	
38	19	PAFZZ	PAOZZ	PAGZZ	PAHZZ	D	.010	5310-00-061-1258 WASHER,LOCK:BEARING KIT MTG MS35333-42 96906	EA	4	18	
38	20	PAFZZ	PAOZZ	PAGZZ	PAHZZ	D	.008	5306-00-225-8500 BOLT,MACHINE:BLOCK LEAD MTG MS90728-35 96906	EA	4	4	
38	21	PAFZZ	PAOZZ	PAGZZ	PAHZZ	D	.010	5310-00-061-1258 WASHER,LOCK:LEAD BLOCK MTG MS45904-76 96906	EA	4	18	
38	22	PAFZZ	PAOZZ	PAGZZ	PAHZZ	D	.008	5305-00-269-3213 SCREW,CAP,HEXAGON HEAD:BRACKET ASSEMBLY MTG MS90725-62 96906	EA	8	8	
38	23	PAFZZ	PAOZZ	PAGZZ	PAHZZ	D	.010	5310-00-061-1258 WASHER,LOCK:BRACKET ASSEMBLY MTG MS45094-76 96906	EA	8	18	
38	24	PAFZZ	PAOZZ	PAGZZ	PAHZZ	D	.008	5305-00-253-5616 SCREW,DRIVE MS21318-22 96906	EA	4	4	
38	25	XBFZZ	XB	XBHZZ	MDOZZ			NAMEPLATE:GENERATOR 72-2459-3 60554 1618624 19899	CLA, CLB CZN, CZM	EA	1	1
38	25	XBFZZ	XB	XBHZZ	MDOZZ			NAMEPLATE:GENERATOR 72-2459-4 30554 30554-72-2459-4 36024	CLC, DGG CZN, CZM	EA	1	1

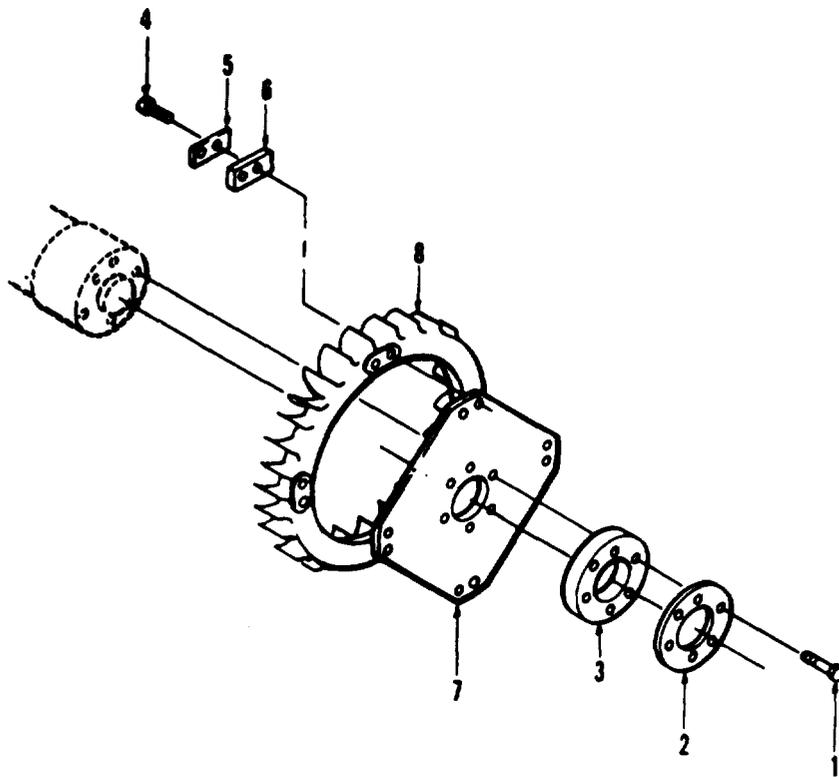

Figure 39. Blower and coupling disc.

TM9-6115-465-24P
 TO 35C2-3-446-4
 NAVFAC P-8-625-24P
 SL-4-06858B/06859D

(1) ILLUSTRATION		(2) SMR CODE				(3)		(4) NATIONAL STOCK NUMBER	(5) DESCRIPTION	(6) USABLE ON CODE	(7) QTY INC IN UNITS	(8) USMC QTY PER EQUIP
A FIG. NO.	B ITEM NO.	A ARMY	B AIR FORCE	C NAVY	D USMC	A SSI	B REPL FACTOR	REF NUMBER & MFR CODE	U/M			
39		XBFZZ	AFO	AHHHD	AHHZZ			BLOWER, COUPLING: GENERATOR 125C213G01 19899	EA	1	1	
39	1	PAFZZ	PAOZZ	PAGZZ	PAHZZ	D	.008	5305-00-042-6417 SCREW, CAP, HEXAGON HEAD: COUPLING DISK TO SHAFT MS90725-113 96906	EA	6	20	
39	2	XBFZZ	PAOZZ	XBHZZ	XBHZZ			PLATE, LOCK: COUPLING DISK 143A832F01 19899 72-2454 30554	EA	1	1	
39	3	XBFZZ	XB	XBHZZ	XBHZZ			PLATE, PRESSURE: DISK COUPLING 143A933F01 19899 72-2453 30554	EA	1	1	
39	4	PAFZZ	PAOZZ	PAGZZ	PAHZZ	D	.008	5305-00-724-5911 SCREW, CAP, HEXAGON HEAD: LOCK PLATE MS90725-163 96906	EA	2	2	
39	5	XBFZZ	MFO	XBHZZ	XBHZZ			5365-00-630-2441 PLATE, LOCK: BLOWER 156B243F01 19899 72-2456 30554	EA	1	1	
39	6	XBFZZ	MFO	XBHZZ	XBHZZ			PLATE, PRESSURE 158B147F01 19899 72-2455 30554	EA	4		
39	7	XBFZZ	XB	XBHZZ	XBHZZ			DISK, COUPLING 125C124F01 19899 72-2452 30554	EA	1	1	
39	8	PAFZZ	PBOZZ	XBHZZ	PAHZZ	D	.007	6115-00-602-5973 BLOWER, FAN: GENERATOR 158B016G01 19899 72-2445 30554	EA	1	1	

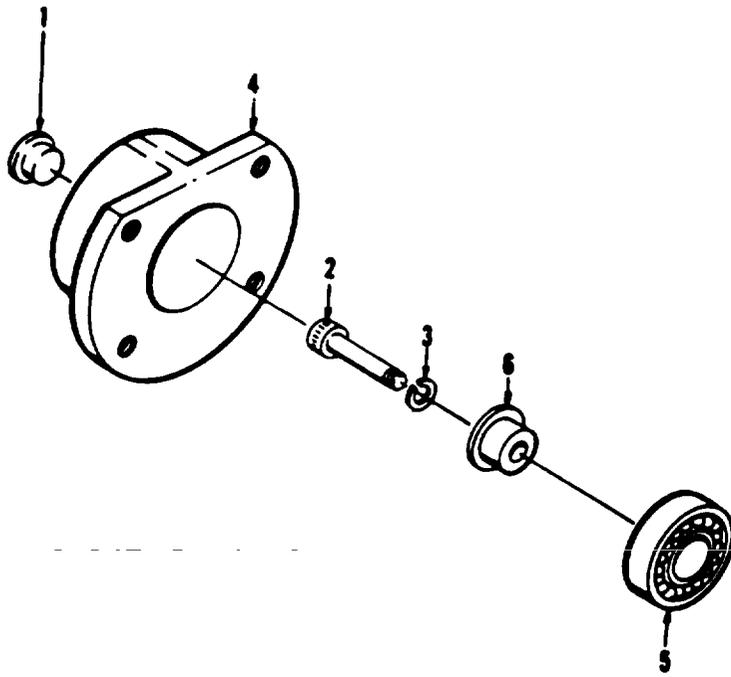

Figure 40. Bearing assembly.

TM9-6115-465-24P
 TO 35C2-3-446-4
 NAVFAC P-8-625-24P
 SL-4-06858B/06859D

(1) ILLUSTRATION		(2) SMR CODE				(3)		(4) NATIONAL STOCK NUMBER	(5) DESCRIPTION	(6) USABLE ON CODE	(7) QTY INC IN UNITS	(8) USMC QTY PER EQUIP
A FIG. NO.	B ITEM NO.	A ARMY	B AIR FORCE	C NAVY	D USMC	A SSI	B REPL FACTOR	REF NUMBER & MFR CODE	U/M			
40		XBFZZ	AOO	AHHZZ	AHHZZ			BEARING ASSEMBLY, SHAFT:GENERATOR 125C209GOI 19899	EA	1	1	
40	1	PAFZZ	PAOZZ	XBGZZ	PAHZZ		.005	5340-00-616-6170 PLUG,CAP 72-2443 30554 10 95760	EA	1	1	
40	2	PAFZZ	PAOZZ	PAGZZ	PAHZZ	D	.008	5305-00-983-7462 SCREW,CAP MS16997-143 96906	EA	1	1	
40	3	PAFZZ	PAOZZ	XBFZZ	PAHZZ	D	.010	5310-00-194-1483 WASHER, LOCK MS35333-44 96906	EA	1	1	
40	4	XBFZZ	PAOZZ	XBHZZ	PAHZZ			3130-00-618-2260 HOUSING, BEARING 125C131FO1 19899 72-2411 30554	EA	1	1	
40	5	PAFZZ	PAOZZ	PAHZZ	PAHZZ		.040	3110-00-141-9994 BEARING, BALL 72-2442 30554 6307-2RS 52676	EA	1	1	
40	6	XBFZZ	PAOZZ	XBHZZ	PAHZZ			3120-00-625-8472 ADAPTER, BEARING 158B124FO1 19899 72-2413 30554	EA	1	1	

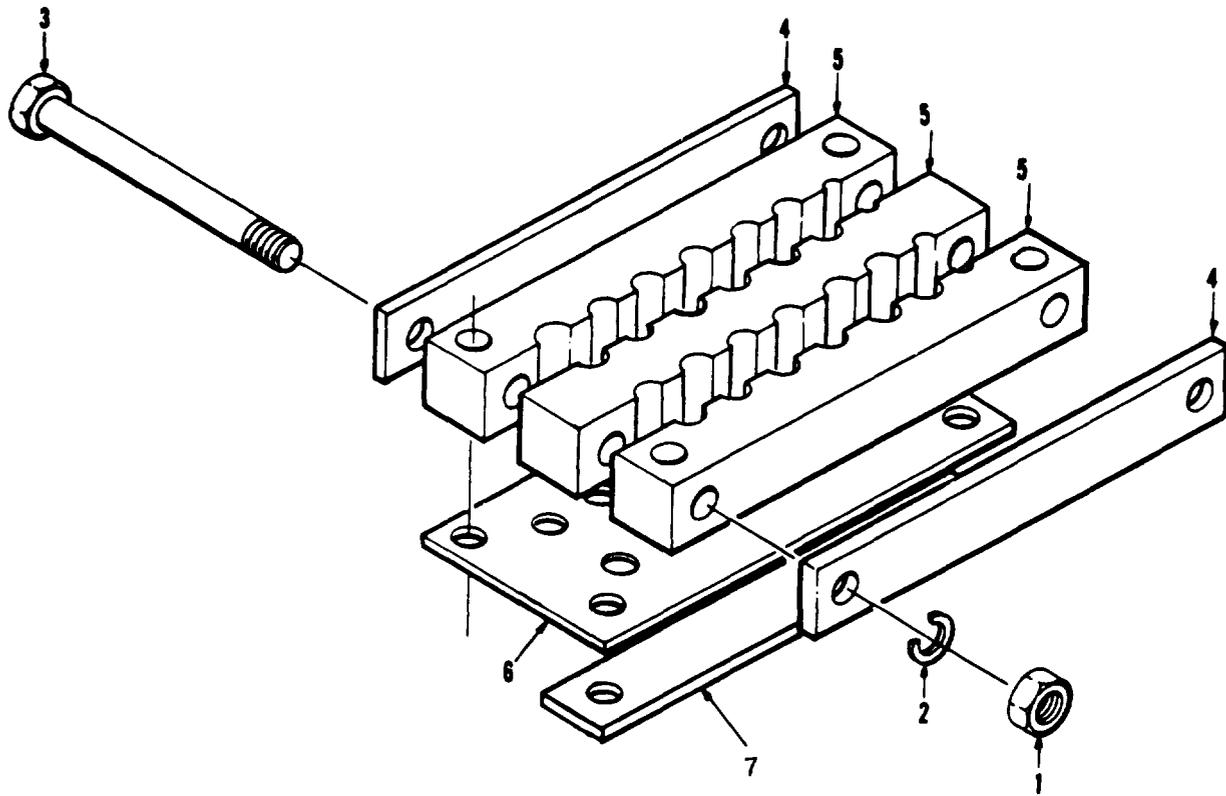

Figure 41. Lead block assembly.

TM9-6115-465-24P
 TO 35C2-3-446-4
 NAVFAC P-8-625-24P
 SL-4-06858B/06859D

(1) ILLUSTRATION		(2) SMR CODE				(3)		(4) NATIONAL STOCK NUMBER	(5) DESCRIPTION	USABLE ON CODE	(6) U/M	(7) QTY INC IN UNITS	(8) USMC QTY PER EQUIP
A FIG. NO.	B ITEM NO.	A ARMY	B AIR FORCE	C NAVY	D USMC	A SSI	B REPL FACTOR	REF NUMBER & MFR CODE					
41		XBFZZ	PAOZZ	XBHZZ	PAHZZ			5975-00-614-9669	BLOCK ASSEMBLY LEAD 125C270GOI 19899		EA	1	1
41	1	PAFZZ	PAOZZ	PAGZZ	PAHZZ	D	.008	5310-00-761-6882	NUT, HEXAGON MS51967-2 96906		EA	2	109
41	2	PAFZZ	PAOZZ	PAGZZ	PAHZZ	D	.010	5310-00-550-1130	WASHER, LOCK-PRESSURE PLATE MS35333-40 96906		EA	2	
41	3	PAFZZ	PAOZZ	PAGZZ	PAHZZ	D	.008	5305-00-071-2519	SCREW, CAP MS90728-22 96906		EA	2	2
41	4	XBFZZ	PAOZZ	XBHZZ	XBHZZ				PLATE, BLANK 158B161F01 19899 72-2447 30554		EA	2	2
41	5	XBFZZ	XA	XAHZZ	XBHZZ				BLOCK, LEAD 125C267FOI 19899		EA	1	1
41	6	PAFZZ	PAOZZ	PAHZZ	PAHZZ		.040	5330-01-017-5616	GASKET 158B468F01 19899 72-2446-2 30554		EA	1	1
41	7	PAFZZ	PAOZZ		PAHZZ		.040	5330-01-102-0619	STRAP, PLASTIC 72-2436 30554 4763 87730	DGG	EA	1	

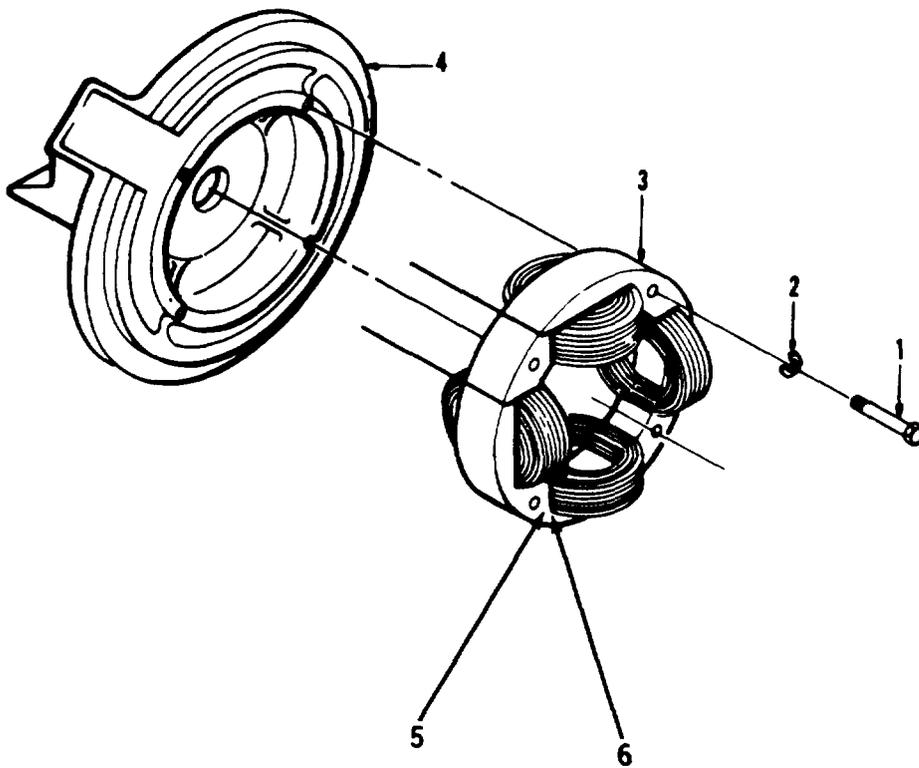

Figure 42. Bracket assembly.

TM9-6115-465-24P
 TO 35C2-3-446-4
 NAVFAC P-8-625-24P
 SL-4-06858B/06859D

(1) ILLUSTRATION		(2) SMR CODE				(3)		(4) NATIONAL STOCK NUMBER	(5) DESCRIPTION	(6) USABLE ON CODE	(7) QTY INC IN UNITS	(8) USMC QTY PER EQUIP
A FIG. NO.	B ITEM NO.	A ARMY	B AIR FORCE	C NAVY	D USMC	A SSI	B REPL FACTOR	REF NUMBER & MFR CODE	U/M			
42		XBFZZ	AOO	XBHZZ	AHHZZ			BRACKET ASSEMBLY 125C204G01 19899	EA	1	1	
42	1	PAFZZ	PAOZZ	PAGZZ	PAHZZ	D	.008	5306-00-226-4834 MS90728-41 96906	EA	4	4	
42	2	PBFZZ	PAOZZ	PAGZZ	PAHZZ	D	.010	5310-00-889-2527 WASHER, LOCK MS45904-72 96906	EA	4	10	
42	3	PBFZZ	PBOZZ	PFBZ	PBHZZ		.050	6115-00-370-2738 EXCITER, STATOR 125C041G01 19899 72-2430 30554	EA	1	1	
42	4	XBFZZ	PBOZZ	XBHZZ	PAHZZ			6115-00-602-5972 BRACKET 107D151F01 19899 72-2469 30554	EA	1	1	
42	5	KFHZZ						SF/DUROID D-2310-.060 04394 85-2000-1 30554	RL	1	1	
42	6	KFHZZ						ADHESIVE, DEPEND 00206 05972 85-2000-2 30554	EA	1	1	
								6115-01-237-3654 KIT, WEDGES, COIL BOBBIN 85-2000 30554	EA	1	1	
42	5		PAOZZ					SF/DUROID	EA	1	1	
42	6							ADHESIVE	EA	1	1	

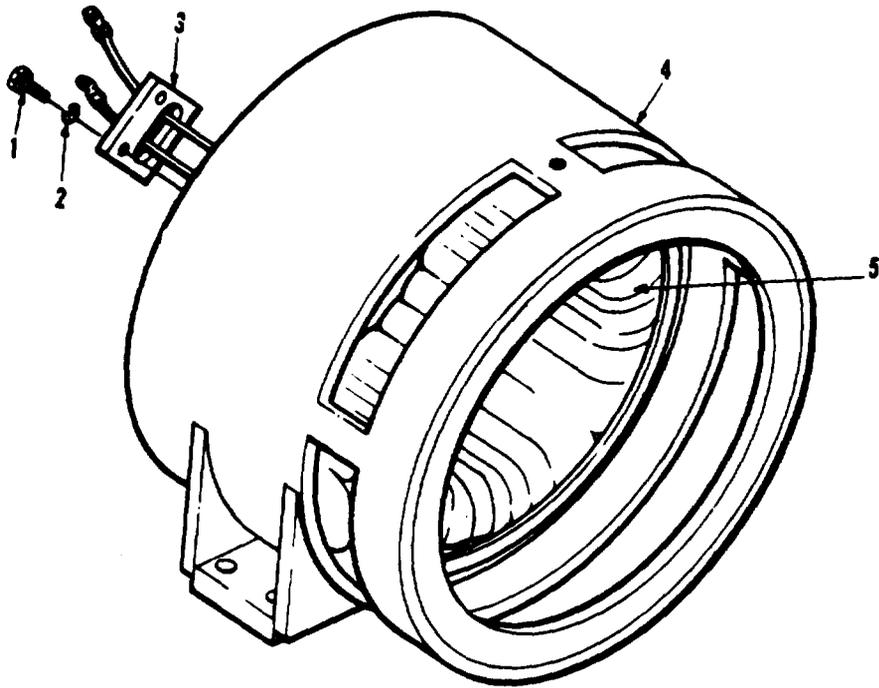

Figure 43. 50/60 Hz stator assembly.

TM9-6115-465-24P
 TO 35C2-3-446-4
 NAVFAC P-8-625-24P
 SL-4-06858B/06859D

(1) ILLUSTRATION		(2) SMR CODE				(3)		(4) NATIONAL STOCK NUMBER	(5) DESCRIPTION	(6) USABLE ON CODE	(7) QTY INC IN UNITS	(8) USMC QTY PER EQUIP	
A FIG. NO.	B ITEM NO.	A ARMY	B AIR FORCE	C NAVY	D USMC	A SSI	B REPL FACTOR	REF NUMBER & MFR CODE	U/M				
43		PBFHH	PBDFP	PBHHD	PBHHH		.700	6115-00-370-2823	STATOR ASSEMBLY 72-2492 30554 158B386G01 19899	CLA, CLB CZN, CZM	EA	1	1
43	1	PAFZZ	PAOZZ	PAGZZ	PAHZZ	D	.008	5306-00-225-8499	BOLT, MACHINE BUSHING MTG MS90725-34 96906	CLA, CLB CZN, CZM	EA	2	2
43	2	PAFZZ	PAOZZ	PAGZZ	PAHZZ	D	.010	5310-00-889-2527	WASHER, LOCK MS45904-72 96906	CLA, CLB CZN, CZM	EA	2	10
43	3	XBFZZ	MFO	XBHZZ	XBHZZ				BUSHING, LEAD 72-2412 30554	CLA, CLB CZN, CZM	EA	1	1
43	4	XAFZZ	XA	XAHZZ	XAHZZ				HOUSING, GENERATOR 72-2414-2 30554	CLA, CLB CZN, CZM	EA	1	1
43	5	XBFZZ	XA	XAHZZ	XAHZZ				WINDING, STATOR 72-2480-2 30554	CLA, CLB	EA	1	1

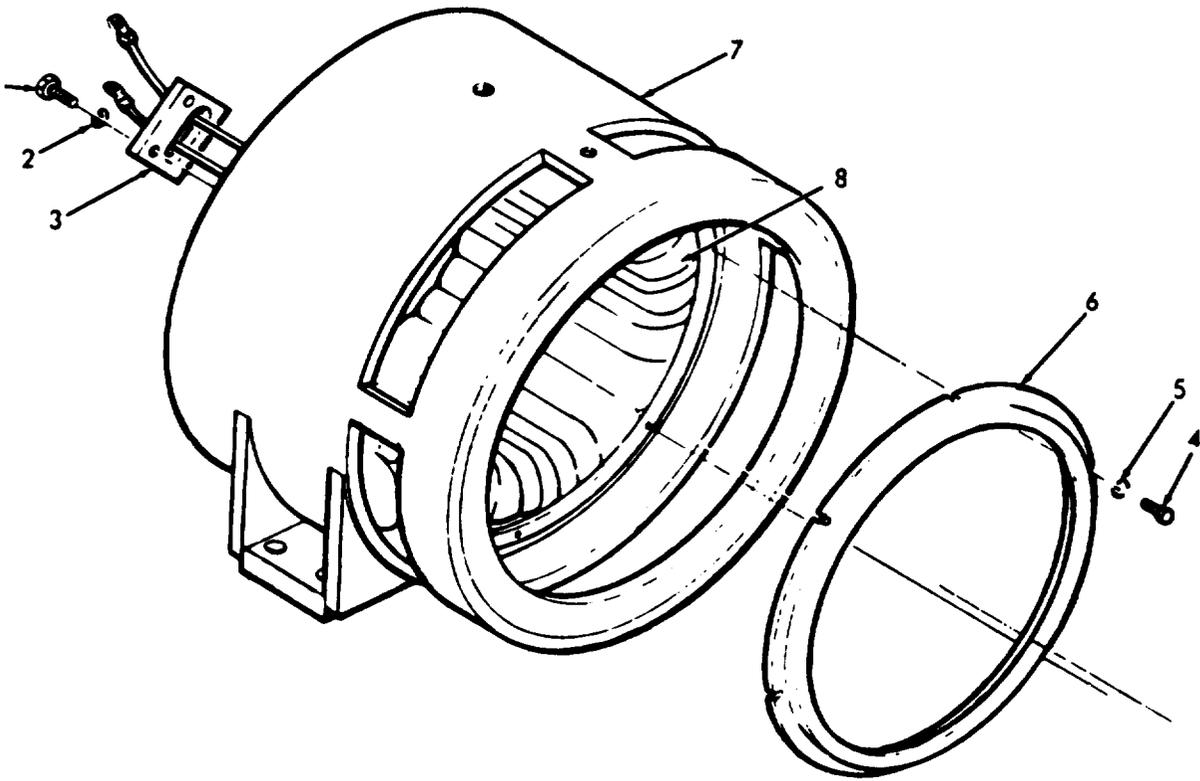

Figure 44. 400 Hz stator assembly.

TM9-6115-465-24P
 TO 35C2-3-446-4
 NAVFAC P-8-625-24P
 SL-4-06858B/06859D

(1) ILLUSTRATION		(2) SMR CODE				(3)		(4) NATIONAL STOCK NUMBER	(5) DESCRIPTION	(6) USABLE ON CODE	(6) U/M	(7) QTY INC IN UNITS	(8) USMC QTY PER EQUIP
A FIG. NO.	B ITEM NO.	A ARMY	B AIR FORCE	C NAVY	D USMC	A SSI	B REPL FACTOR	REF NUMBER & MFR CODE					
44		PBFHH	PBOFF	PBHHD	PBHHH		.007	6115-00-370-2749	STATOR ASSEMBLY 72-2489 30554 158B453G01 19889	CLC,DGG	EA	1	1
44	1	PAFZZ	PAOZZ	PAGZZ	PAHZZ	D	.008	5306-00-225-8499	BOLT,MACHINE:BUSHING MTG MS90725-34 96906	CLC,DGG	EA	2	
44	2	PAFZZ	PAOZZ	PAGZZ	PAHZZ	D	.010	5310-00-889-2527	WASHER,LOCK MS45904-72 96906	CLC,DGG	EA	2	
44	3	XBFZZ	MFO	XBHZZ	XBHZZ				BUSHING,LEAD 158B166F01 19889	CLC,DGG	EA	1	
44	4	PAFZZ	PAOZZ	PAGZZ	PAHZZ	D	.008	5305-00-068-0500	SCREW,CAP MS90725-3 96906	CLC,DGG	EA	6	
44	5	PAFZZ	PAOZZ	PAGZZ	PAHZZ	D	.010	5310-00-550-1130	WASHER,LOCK MS35333-40 96906	CLC,DGG	EA	6	
44	6	XBFZZ	XA	XBHZZ	XBHZZ				BAFFLE 158B199F01 19889	CLC,DGG	EA	1	
44	7	XAFZZ	XA	XAHZZ	XAHZZ				STATOR 125C311G01 19889	CLC,DGG	EA	1	
44	8	XAFZZ	XA	XAHZZ	XAHZZ				STATOR WINDING 122F430G01 19889	CLC,DGG	EA	1	

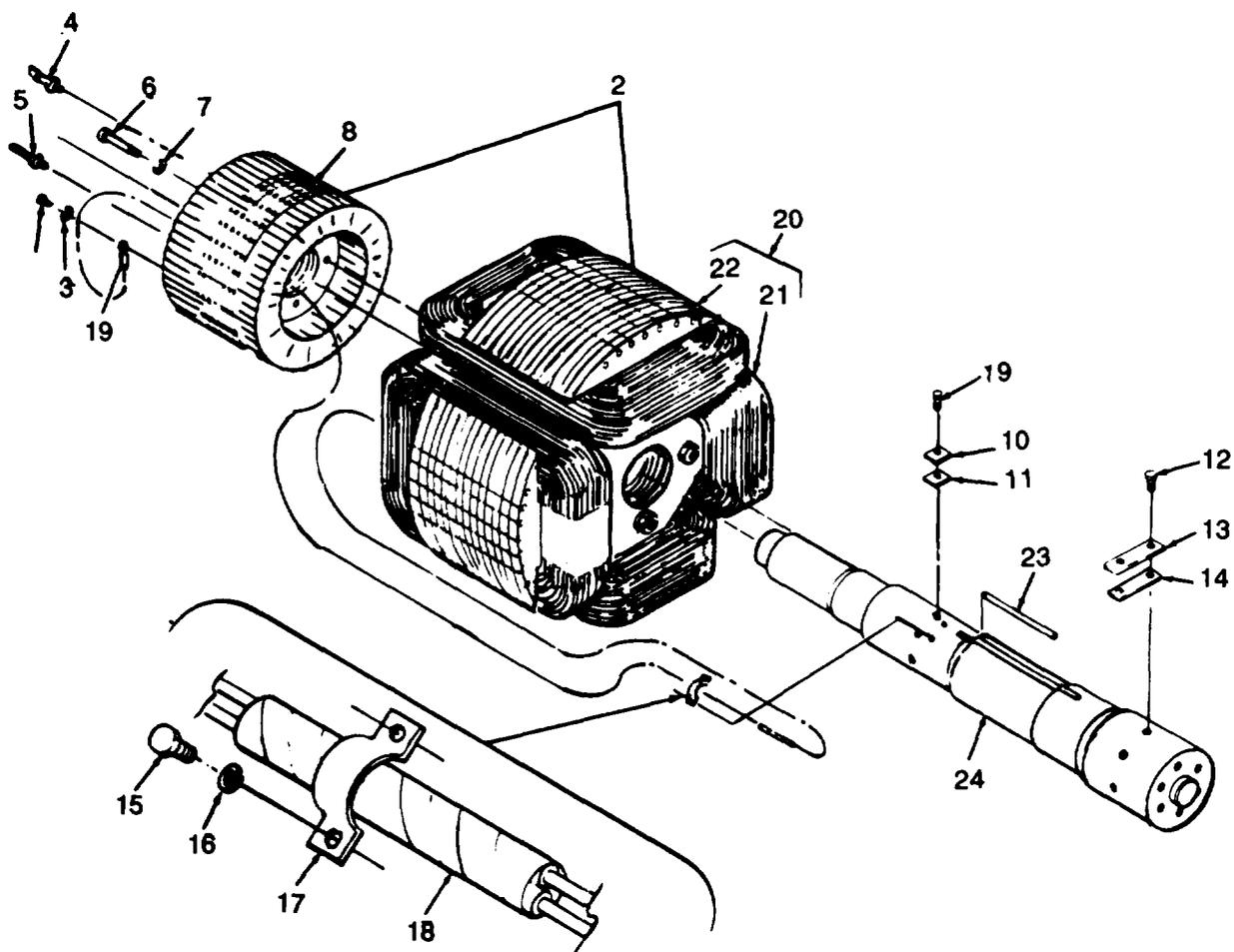

Figure 45. 50/60 Hz rotor assembly.

(1) ILLUSTRATION		(2) SMR CODE				(3)		(4) NATIONAL STOCK NUMBER	(5) DESCRIPTION	(6) USABLE ON CODE	(7) QTY INC IN UNITS	(8) USMC QTY PER EQUIP
A FIG. NO.	B ITEM NO.	A ARMY	B AIR FORCE	C NAVY	D USMC	A SSI	B REPL FACTOR	REF NUMBER & MFR CODE	U/M			
45		PAFDD	PBOFF	PBHHH	PBHHH		.100	6115-00-370-2801 ROTOR ASSEMBLY GENERATOR 72-2427 30554 125C129G02 19899	CLA, CLB EA	1	1	
45	1	PAFZZ	PAOZZ	PAGZZ	PAHZZ	D	.008	5305-00-068-0498 SCREW MACHINE MS90725-1 96906	CLA, CLB CZN, CZM	EA	2 2	
45	2	XAFZZ	XA	XBHHD	XAHZZ			ROTOR ASSEMBLY 125C263G01 19899	CLA, CLB CZN, CZM	EA	1	
45	3	PAFZZ	PAOZZ	PAGZZ	PAHZZ	D	.010	5310-00-550-1130 WASHER, LOCK: TERMINAL LUG MS35333-40 96906	CLA, CLB CZN, CZM	EA	2	
45	4	PAFZZ	PAHZZ	PAHZZ	PAHZZ		.040	5961-00-892-0888 DIODE JAN1N1190 81349	CLA, CLB CZN, CZM	EA	3 3	
45	5	PAFZZ	PAHZZ	PAHZZ	PAHZZ		.040	5961-00-901-2290 DIODE JAN1N1190R 81349	CLA, CLB CZN, CZM	EA	3 3	
45	6	PAFZZ	PAOZZ	PAGZZ	PAHZZ	D	.008	5305-00-071-2237 SCREW MACHINE MS90725-14 96906	CLA, CLB CZN, CZM	EA	4 4	
45	7	PAFZZ	PAOZZ	PAGZZ	PAHZZ	D	.010	5310-00-550-1130 WASHER, LOCK MS35333-40 96906	CLA, CLB CZN, CZM	EA	4	
45	8	PADZZ	PBOZZ	XAHZZ	PBHZZ		.010	6115-00-567-9435 ROTOR, EXCITER 72-2403 30554 125C047G01 19899	CLA, CLB CZN, CZM	EA	1 1	
45	9	PAHZZ	PAOZZ	PAGZZ	PAHZZ	D	.008	5305-00-269-3211 SCREW, CAP HEXAGON HEAD: WEIGHT MTG MS90725-60 96906	CLA, CLB CZN, CZM	EA	6 10	
45	10	XBHZZ	XB	XAGZZ	XBHZZ			WEIGHT, BALANCE 158B142F03 19899	CLA, CLB CZN, CZM	EA	V	
45	11	XBHZZ	XB	XAHZZ	XBHZZ			WEIGHT, BALANCE 158B14F04 19899	CLA, CLB CZN, CZM	EA	V	
45	12	PAHZZ	PAOZZ	PAGZZ	PAHZZ	D	.008	5305-00-269-3214 SCREW, CAP MS90725-64 96906	CLA, CLB CZN, CZM	EA	6 6	
45	13	XBHZZ	XB	XAHZZ	XBHZZ			WEIGHT, BALANCE 158B142F01 19899	CLA, CLB CZN, CZM	EA	V	
45	14	XBHZZ	XB	XAHZZ	XBHZZ			WEIGHT, BALANCE 158B142F02 19899	CLA, CLB CZN, CZM	EA	V	
45	15	PAHZZ	PAOZZ	PAGZZ	PAHZZ	D	.008	5305-00-068-0498 SCREW MACHINE: CLAMP MTG MS90725-1 96906	CLA, CLB CZN, CZM	EA	2 2	
45	16	PAHZZ	PAOZZ	PAGZZ	PAHZZ	D	.010	5310-00-550-1130 WASHER, LOCK: CLAMP MTG MS35333-40 96906	CLA, CLB CZN, CZM	EA	2	
45	17	PAHZZ	PAOZZ	PAGZZ	PAHZZ	D	.008	5340-00-616-5652 CLAMP, LEAD 143A930F01 19899	CLA, CLB EA	EA	1	
45	18	XBHZZ	XB	XBHZZ	PAHZZ			5970-00-543-1154 TAPE M1LY1140CLASSCFORM 81349	CLA, CLB CZN, CZM	FT	V	
45	19	XBHZZ	PAOZZ	PAGZZ	PAHZZ			5940-00-143-4777 LUG, TERMINAL MS25036-157 96906	CLA, CLB CZN, CZM	EA	2 4	
45	20	XAHZZ	XA	XAHZZ	XAHZZ			ROTOR 158B387G01 19899	CLA, CLB CZN, CZM	EA	1 1	
45	21	XAHZZ	XA	XAHZZ	XAHZZ			WINDING ROTOR 122P425G01 19899	CLA, CLB CZN, CZM	EA	1 1	

TM9-6115-465-24P
 TO 35C2-3-446-4
 NAVFAC P-8-625-24P
 SL-4-06858B/06859D

(1) ILLUSTRATION		(2) SMR CODE				(3)		(4) NATIONAL STOCK NUMBER	(5) DESCRIPTION	(6) USABLE ON CODE	(7) QTY INC IN UNITS	(8) USMC QTY PER EQUIP
A FIG. NO.	B ITEM NO.	A ARMY	B AIR FORCE	C NAVY	D USMC	A SSI	B REPL FACTOR	REF NUMBER & MFR CODE	U/M			
45	22	XAHZZ	XA	XAHZZ	XAHZZ			CORE, ROTOR 125C262G01 19899	EA	1	1	
45	23	XBFZZ	XB	XBHZZ	XBHZZ			KEY 143A929F04 19889	EA	1	1	
45	24	XAFZZ	XA	XAHZZ	XAHZZ			SHAFT 72-2402 30554 125C260F01 19899	EA	1	1	

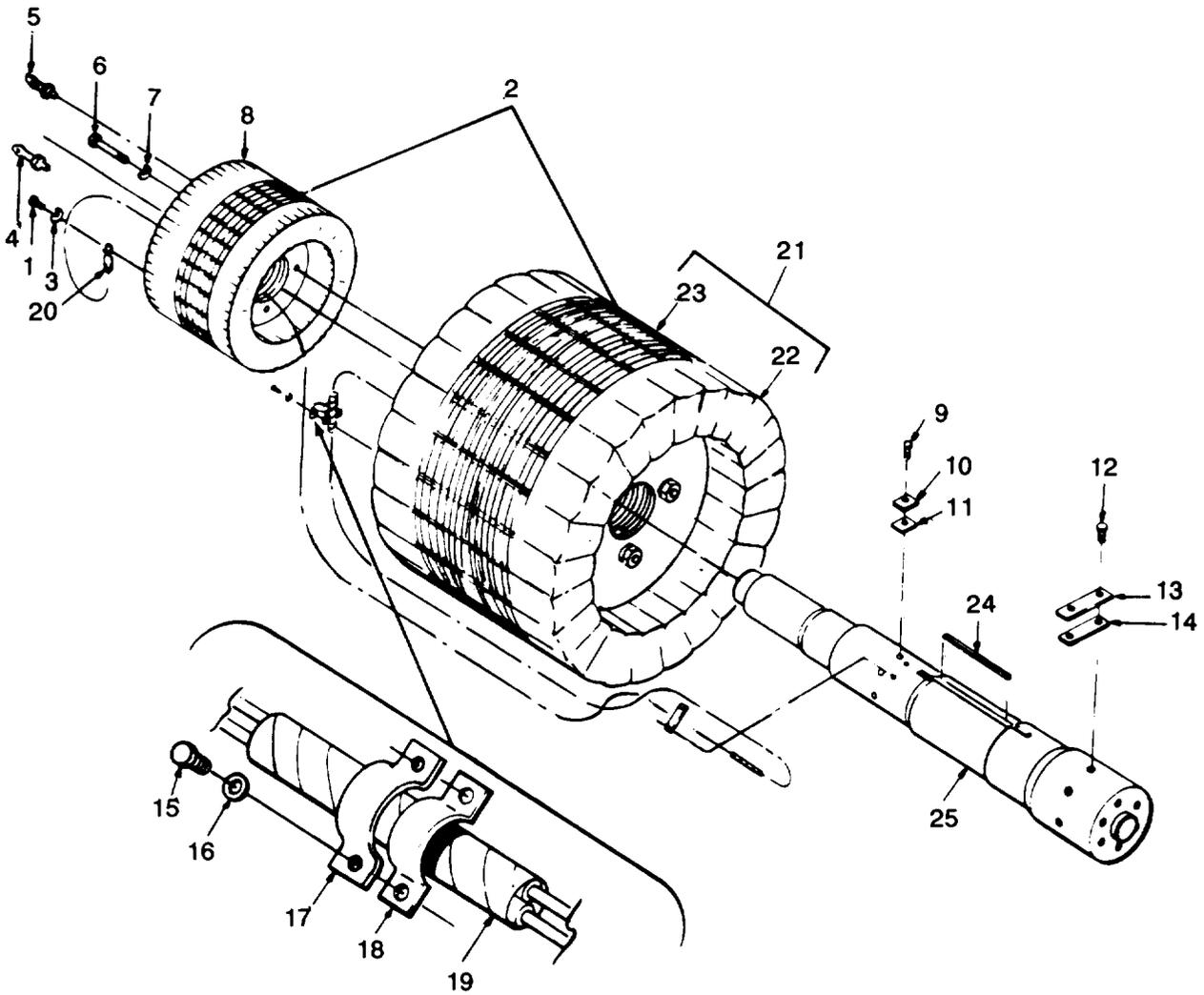

Figure 46. 400 Hz rotor assembly.

(1) ILLUSTRATION A FIG. NO.	(2) SMR CODE B ITEM NO.	A	B	C	D	(3) A SSI	B REPL FACTOR	(4) NATIONAL STOCK NUMBER	(5) DESCRIPTION REF NUMBER & MFR CODE	(6) USABLE ON CODE U/M	(7) QTY INC IN UNITS	(8) USMC QTY PER EQUIP
46		PAFDD	PBOFF	PBHHH	PBHHH		.005	6115-00-370-2797	ROTOR ASSEMBLY: GENERATOR 72-2429 30554 125C324G01 19899	CLC, DGG	EA	1
46	1	PAFZZ	PAOZZ	PAGZZ	PAHZZ	D	.008	5305-00-068-0498	SCREW, MACHINE: TERMINAL LUG MS90725-1 96906	CLC, DGG	EA	2
46	2	XAFZZ	XA	XAHHD	XAHZZ				ROTOR ASSEMBLY 125C263G01 19899	CLC, DGG	EA	2
46	3	PAFZZ	PAOZZ	PAGZZ	PAHZZ	D	.010	5310-00-889-2528	WASHER, LOCK: TERMINAL LUG MS45904-68 96906	CLC, DGG	EA	2
46	4	PAFZZ	PAOZZ	PAHZZ	PAHZZ		.050	5961-00-892-0888	DIODE JAN1N1190 81349	CLC, DGG	EA	3
46	5	PAFZZ	PAOZZ	PAHZZ	PAHZZ		.050	5961-00-901-2290	DIODE JAN1N1190R 81349	CLC, DGG	EA	3
46	6	PAFZZ	PAOZZ	PAGZZ	PAGZZ	D	.008	5305-00-071-2237	SCREW, CAP, HEXAGON HEAD: ROTOR MTG MS90725-14 96906	CLC, DGG	EA	4
46	7	PAFZZ	PAOZZ	PAGZZ	PAFZZ	D	.010	5310-00-550-1130	WASHER, LOCK: ROTOR MTG MS35333-40 96906	CLC, DGG	EA	2
46	8	PADZZ	PBOZZ	XAHZZ	PAHZZ		.005	6115-01-248-5316	ROTOR, EXCITER 72-2403 30554	CLC, DGG	EA	1
46	9	PAHZZ	PAOZZ	PAGZZ	PAHZZ	D	.008	5305-00-269-3211	SCREW, CAP, HEXAGON HEAD: WEIGHT MTG MS90725-60 96906	CLC, DGG	EA	6
46	10	XBHZZ	XB	XAHZZ	XBHZZ				WEIGHT, BALANCE 158B142F03 19899	CLC, DGG	EA	V
46	11	XBHZZ	XB	XAHZZ	XBHZZ				WEIGHT, BALANCE 158B142F04 19899	CLC, DGG	EA	1
46	12	PAHZZ	PAOZZ	PAGZZ	PAHZZ	D	.008	5305-00-269-3214	SCREW, CAP, HEXAGON HEAD: WEIGHT MTG MS90725-64 96906	CLC, DGG	EA	6
46	13	XBHZZ	XB	XAHZZ	XBHZZ				WEIGHT, BALANCE 158B142F01 19899	CLC, DGG	EA	V
46	14	XBHZZ	XB	XAHZZ	XBHZZ				WEIGHT, BALANCE 158B142F02 19899	CLC, DGG	EA	V
46	15	PAHZZ	PAOZZ	PAGZZ	PAHZZ	D	.008	5305-00-068-0498	SCREW, MACHINE: CLAMP MTG MS90725-1 96906	CLC, DGG CZN, CZM	EA	2
46	16	PAHZZ	PAOZZ	PAGZZ	PAHZZ	D	.010	5310-00-889-2528	WASHER, LOCK MS45904-68 96906	CLC, DGG	EA	2
46	17	XBHZZ	PAOZZ	XBHZZ	PAHZZ			5340-00-616-5652	CLAMP, LEAD 143A930F01 19899	CLC, DGG	EA	1
46	18	XBHZZ	XB	XBHZZ	XBHZZ				INSULATOR, CLIP 143A941F01 19899	CLC, DGG	EA	1
46	19	XBHZZ	XB	XBHZZ	PAHZZ			5970-00-543-1154	TAPE: WIRING MILY1140CLASSFORM 81349	CLC, DGG	FT	V
46	20	XBHZZ	PAOZZ	PAGZZ	PAHZZ			5940-00-143-4777	LUG, TERMINAL MS25036-157 96906	CLC, DGG	EA	2

TM9-6115-465-24P
 TO 35C2-3-446-4
 NAVFAC P-8-625-24P
 SL-4-06858B/06859D

(1) ILLUSTRATION		(2) SMR CODE				(3)		(4) NATIONAL STOCK NUMBER	(5) DESCRIPTION	(6)		(7) QTY INC IN UNITS	(8) USMC QTY PER EQUIP
A FIG. NO.	B ITEM NO.	A ARMY	B AIR FORCE	C NAVY	D USMC	A SSI	B REPL FACTOR	REF NUMBER & MFR CODE	USABLE ON CODE	U/M			
46	21	XBHZZ	XA	XAHHD	XAHZZ			ROTOR 158B387G01 19889	CLC,DGG	EA	1		
46	22	XAHZZ	XA	XAHZZ	XAHZZ			WINDING,ROTOR 122F431F01 19899	CLC,DGG	EA	1		
46	23	XAHZZ	XA	XAHZZ	XAHZZ			CORE,ROTOR 158B442G01 19899	CLC,DGG	EA	1		
46	24	XBHZZ	XB	XBHZZ	XBHZZ			KEY:SHAFT 143A929F06 19899	CLC,DGG	EA	1		
46	25	XAFZZ	XA	XAHZZ	XAHZZ			SHAFT 125C273F01 19899	CLC,DGG	EA	1		

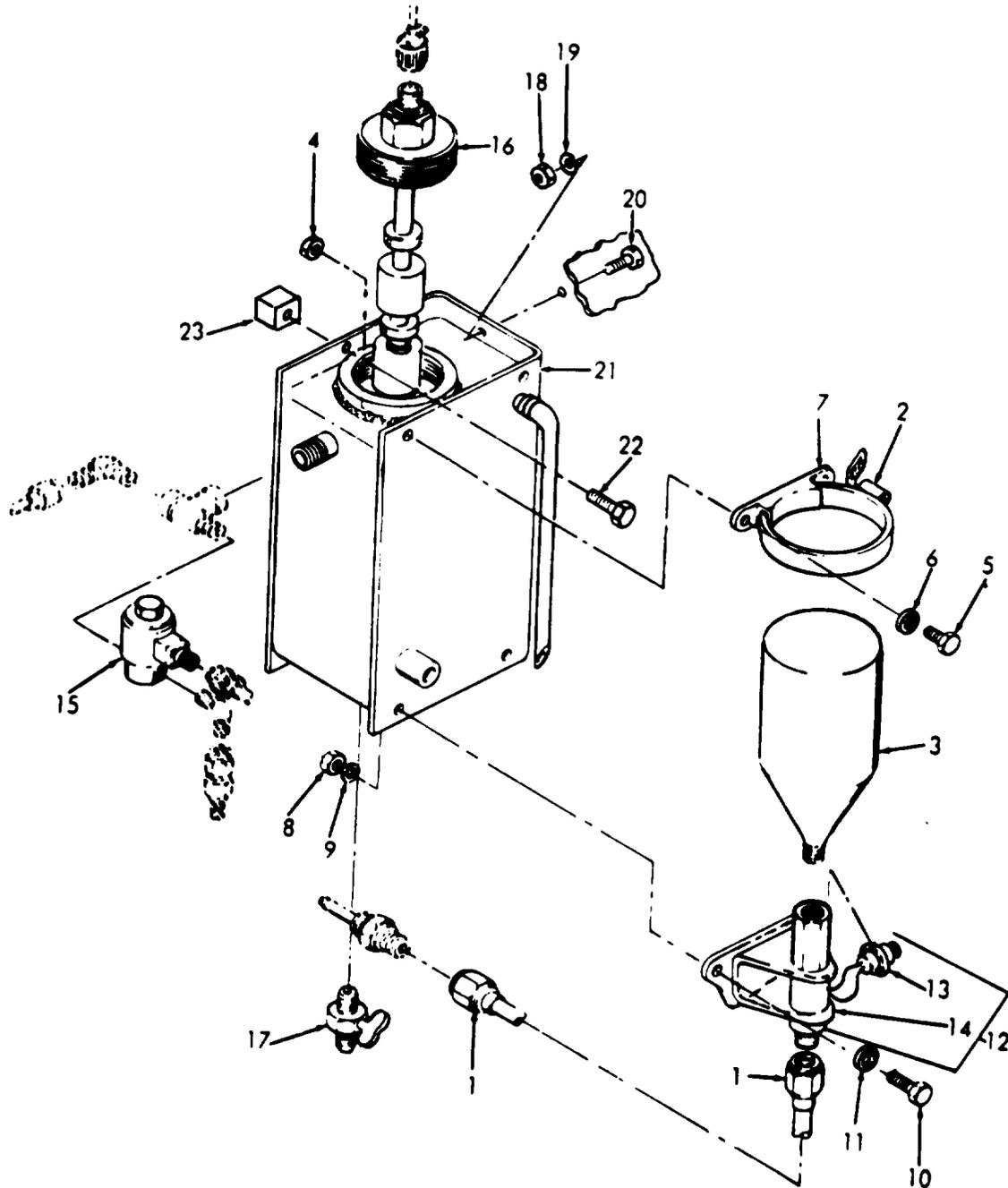

Figure 47. Day tank and ether starting aid.

**TM 9-6115-465-24P
TO 35C2-3-446-4
NAVFAC P-8-625-24P
SL-4-06858B/06859D**

(1) ILLUS- TRATION		(2) SMR CODE				(3)		(4)	(5) DESCRIPTION		(6)	(7)	(8)
a	b	a	b	c	d	a	b	NATIONAL STOCK NUMBER	REF NUMBER & MFR CODE	USABLE ON CODE	U/M	QTY INC IN UNIT	USMC QTY PER EQUIP
FIG NO.	ITEM NO.	ARMY	AIR FORCE	NAVY	USMC	SSI	REPL FACTOR						
									GROUP 15 - DAY TANK AND FUEL FILTER ASSEMBLY				
47	1	PAOZZ	PAOZZ	MOOZZ	PAOZZ	D	.004	4710-00-8049249	TUBE, ETHER 72-2149 30554		FT	1	3
47	2	XBOZZ	PAOZZ	XBGZZ	PAOZZ	D	.013	4730-01-022-8535	CLAMP, ETHER TANK 70-1611 30554 240068 50999		EA	1	
47	3	PAOZZ	PAOZZ	XBGZZ	PAOZZ	-	.125	2910-00-209-4997	TANK ETHER 7-1608 30554 240090 50999				
47	4	PAOZZ	PAOZZ	PAGZZ	PAOZZ	D	.008	5310-00-761-6882	NUT, PLAIN, HEXAGON ETHER TANK MTG BRACKET MS51967-2 96906		EA	2	109
47	5	PAOZZ	PAOZZ	PAOZZ	PAOZZ	D	.008	530s00-06-0500	SCREW CAP HEXAGON HEAD ETHER TANK MTG BRACKET MS907253 96906		EA	2	179
47	6	PAOZZ	PAOZZ	PAGZZ	PAOZZ	D	.010	5310-00-582-5965	WASHER LOCK ETHER TANK MTG BRACKET MS35338-44 96906		EA	2	256
47	7	XBOZZ	XBOZZ	XBGZZ	PAOZZ	-	-		BRACKET, TANK ETHER 70-1610 30554		EA	1	1
47	8	PAOZZ	PAOZZ	PAGZZ	PAFZZ	D	.008	5310-00-761-6882	NUT PLAIN, HEXAGON SOLENOID VALVE MTG MS51967-2 96906		EA	2	109
47	9	PAOZZ	PAOZZ	PAGZZ	PAFZZ	D	.010	5310-00-582-5865	WASHER, LOCK ETHER SOLENOID VALVE MTG MS35338-44 96906		EA	2	256
47	10	PAOZZ	PAOZZ	PAOZZ	PAFZZ	D	.008	5305--00-068-0500	SCREW, CAP, HEXAGON HEAD: ETHER SOLENOID VALVE MTG MS90725-3 96906		EA	2	179
47	11	PAOZZ	PAOZZ	PAOZZ	PAFZZ	D	.010	5310-00-823-8804	WASHER, FLAT: ETHER SOLENOID VALVE MTG M327183 96906		EA	1	45
47	12	PAOZZ	PAOZZ	AGGG	AFFZZ	-	-	4820-01-025-7632	VALVE, SOLENOID: ETHER 72-2299 30554 30554-72-2299 36024		EA	1	1
47	13	XAOZZ	PAOZZ	PAGZZ	PAFZZ	D	.023	5935-00-936-7841	CONNECTOR MS3101R10SL4P 96906		EA	1	1
47	14	XAOZZ	PAOZZ	PAGZZ	PAFZZ	D	.050	4810-00-357-0538	VALVE, SOLENOID 70-1609 30554 240091 50999		EA	1	1
47	15	PAOZZ	PAOZZ	PAGZZ	PAFZZ	-	.050	4810-00-216-1849	VALVE, SOLENOID: FUEL 69-787-2 30554		EA	1	1
47	16	PAOZZ	PAOZZ	PAHZZ	PAOZZ	-	.015	2910-00-405-6153	SWITCH, LEVEL: FUEL 70-1594 30554		EA	1	1
47	17	PAOZZ	PAOZZ	XBOZZ	PAOZZ	D	.005	4820-00-254-8641	COCK, DRAIN: DAY TANK 630 79470 72-2297-1 30554		EA	1	1
47	18	PAOZZ	PAOZZ	PAGZZ	PAFZZ	D	.006	5310-00-880-7744	NUT, PLAIN, HEXAGON DAY: TANK MTG MS51967-5 96906		EA	2	24

TM9-6115-465-24P
 TO 35C2-3-446-4
 NAVFAC P-8-625-24P
 SL-4-06858B/06859D

(1) ILLUSTRATION		(2) SMR CODE				(3)		(4) NATIONAL STOCK NUMBER	(5) DESCRIPTION	(6) USABLE ON CODE	(7) QTY INC IN UNITS	(8) USMC QTY PER EQUIP
A FIG. NO.	B ITEM NO.	A ARMY	B AIR FORCE	C NAVY	D USMC	A SSI	B REPL FACTOR	REF NUMBER & MFR CODE	U/M			
47	19	PAOZZ	PAOZZ	PAGZZ	PAFZZ	D	.010	5310-00-407-9566	WASHER, LOCK: DAY TANK MTG MS35338-45 96906	EA	2	26
47	20	PAOZZ	PAOZZ	PAGZZ	PAFZZ	D	.008	5306-00-225-8497	BOLT, MACHINE: DAY TANK MTG MS90725-32 96906	EA	2	44
47	21	XBOZZ	XB	XBGZZ	PAFZZ				TANK, DAY 72-2100 30554 30554-72-2100 36024	EA	1	1
47	22	PAOZZ	PAOZZ	XBGZZ	PAFZZ			5305-00-038-3096	SCREW & CAPTIVE WASHER 69-662-32 30554 P15121-32 45722	EA	1	
47	23	PAOZZ	PAOZZ	PAGZZ	PAFZZ			5961-00-394-0902	RECTIFIER ASSEMBLY 70-1599 30554 B470 06288	EA	1	

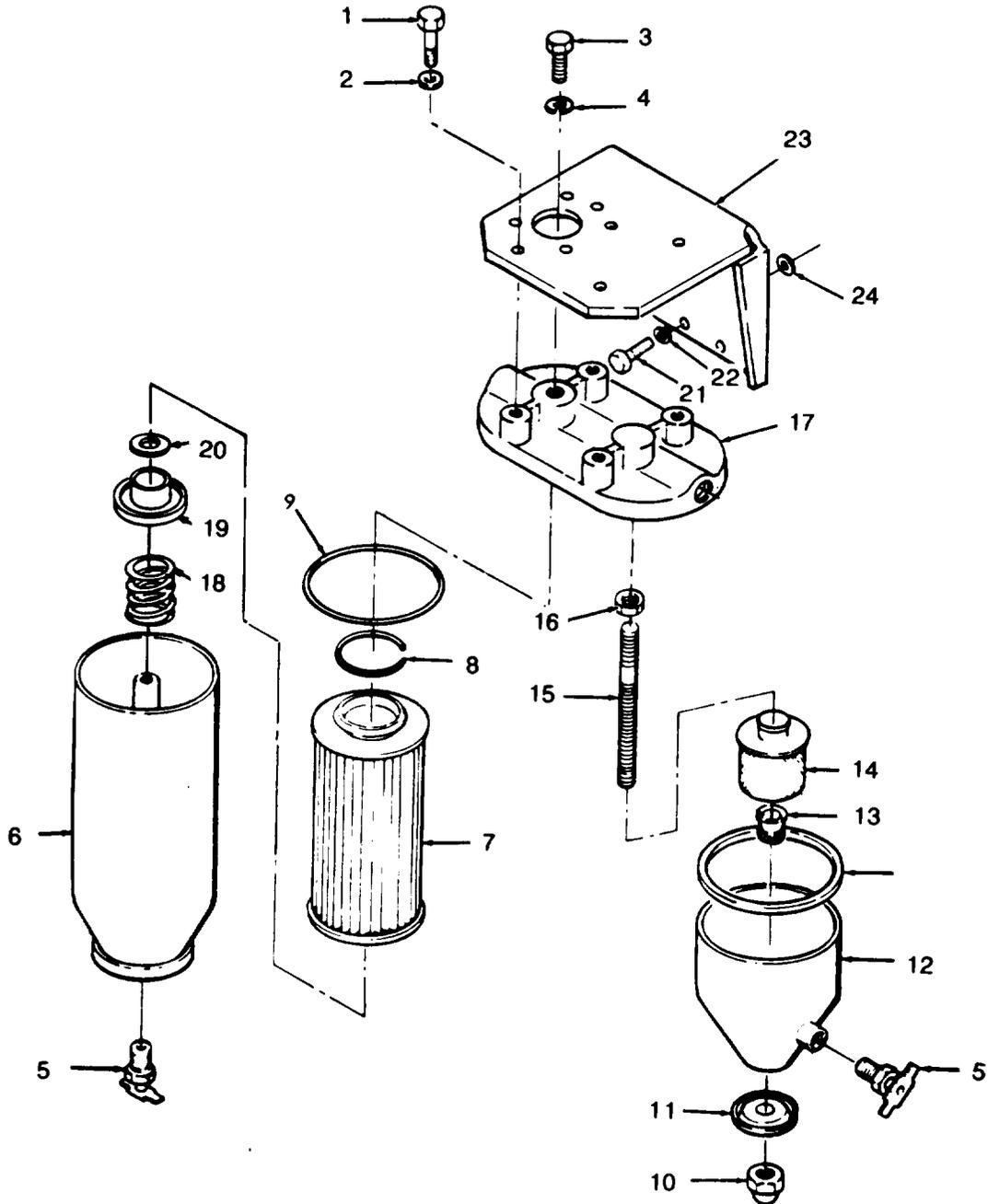

Figure 48. Primary fuel filter and strainer.

**TM 9-6115-465-24P
TO 35C2-3-446-4
NAVFAC P-8-625-24P
SL-4-06858B/06859D**

(1) ILLUS- TRATION		(2) SMR CODE				(3)		(4)	(5) DESCRIPTION		(6)	(7)	(8)
a	b	a	b	c	d	a	b	NATIONAL STOCK NUMBER	REF NUMBER & MFR CODE	USABLE ON CODE	U/M	QTY INC IN UNIT	USMC QTY PER EQUIP
FIG NO.	ITEM NO.	ARMY	AIR FORCE	NAVY	USMC	SSI	REPL FACTOR						
48	1	PAOZZ	PAOZZ	PAOZZ	PAOZZ	D	.008	5305-00-269-3210	SCREW, CAP, HEXAGON HEAD MS90725-59 96906		EA	4	7
48	2	PAOZZ	PAOZZ	PAOZZ	PAOZZ	D	.010	5310-00-637-9541	WASHER, LOCK: FILTER MTG MS35338-46 96906		EA	4	104
48		XBOXX	PAOZZ	AOOOG	AOOOC	-	-	2910-00-085-5598	FUEL FILTER 70-507 30554 30554-70-507 36024		EA	1	1
48	3	PAOZZ	PAOZZ	PAGZZ	PAOZZ	D	.008	5305-00-709-8540	SCREW, MACHINE MS90726-90 96906		EA	1	1
48	4	PAOZZ	PAOZZ	PAOZZ	PAOZZ	-	.040	5310-00-630-2801	WASHER, COPPER 70-507-03 30554		EA	1	2
48	5	PAOZZ	PAOZZ	PAGZZ	PAOZZ	D	.005	4820-00-752-9040	COCK, DRAIN MS35782-4 96906		EA	2	4
48	6	XAOZZ	XA	XAGZZ	XAOZZ	-	-		CAN, FILTER 30554-70-507-5 36024		EA	1	2
48	7	PAOZZ	PAOZZ	PAOZZ	PAOZZ	-	2.000	2910-00-287-1912	ELEMENT, FILTER C1126PL 73370		EA	1	2
48	8	XBOZZ	PAOZZ	XBGZZ	PAOZZ	-	.013	5365-01-024-9931	RING, RETAINER MS16632-1056 96906		EA	1	2
48	9	PAOZZ	PAOZZ	PAOZZ	PAOZZ	-	2.000	5330-01-391-9654	GASKET 440035 91265		EA	2	3
48	10	PAOZZ	PAOZZ	PAOZZ	PAOZZ	D	.008	5310-00-059-9268	NUT, ACORN: CAN MTG MS24680, 96906		EA	1	1
48	11	PAOZZ	PAOZZ	PAOZZ	PAOZZ	-	.040	5310-01-017-2501	WASHER COPPER: CAN MTG 7507-22 30554 245125 77445		EA	1	1
48	12	XAOZZ	XA	XAGZZ	XAOZZ	-	-		CAN, STRAINER 30554-70-507-15 36024		EA	1	1
48	13	PAOZZ	PAOZZ	XBGZZ	PAOZZ	D	.008	5305-00-710-4195	NUT, CUP 30554-70-507-9 36024		EA	1	1
48	14	PAOZZ	PAOZZ	PAOZZ	PAOZZ	-	.040	2910-00-222-2216	CARTRIDGE 70-508 30554 35070 73370		EA	1	1
48	15	XBOZZ	MOO	XBGZZ	XBOZZ				STUD, PLAIN 30554-70-507-12- 36024		EA	1	1
48	16	PAOZZ	PAOZZ	PAOZZ	PAOZZ	D	.008	5310-00-880-7744	NUT, HEXAGON MS51967-5 96906		EA	1	1
48	17	XAOZZ	XA	XAGZZ	XAOZZ	-	-		HEAD, FILTER 30554-70-507-1 36024		EA	1	1
48	18	XBOZZ	PAOZZ		XBOZZ				SPRING, TENSION 4920-87 02032	CZN	EA	1	
48	19	PAOZZ	XA		PAOZZ				SEALING PLATE 4920-89 02032	CZN	EA	1	
48	20	PAOZZ	PAOZZ		PAOZZ			5330-00-582-2855	PACKING, PREFORMED P383-2 75214	CZN	EA	1	
48	21	PAOZZ	PAOZZ	PAOZZ	PAOZZ	D	.008	5305-00-269-3211	SCREW, CAPHEXAGON HEAD: BRACKET MTG MS90725-6 96906		EA	4	

TM9-6115-465-24P
 TO 35C2-3-446-4
 NAVFAC P-8-625-24P
 SL-4-06858B/06859D

(1) ILLUSTRATION		(2) SMR CODE				(3)		(4) NATIONAL STOCK NUMBER	(5) DESCRIPTION	(6) USABLE ON CODE	(7) QTY INC IN UNITS	(8) USMC QTY PER EQUIP
A FIG. NO.	B ITEM NO.	A ARMY	B AIR FORCE	C NAVY	D USMC	A SSI	B REPL FACTOR	REF NUMBER & MFR CODE	U/M			
48	22	PAOZZ	PAOZZ	PAOZZ	PAOZZ	D	.010	5310-00-637-9541	WASHER, LOCK MS35338-46 96906	EA	4	
48	23	PAOZZ	XB	XBGZZ	XBOZZ				BRACKET:FUEL FILTER MTG 40-0003640D 28265	EA	1	1
48	24	XBOZZ	XB	XBGZZ	XBOZZ			5340-00-400-0076	SPACER:BRACKET MTG 200087A 28265	EA	4	8

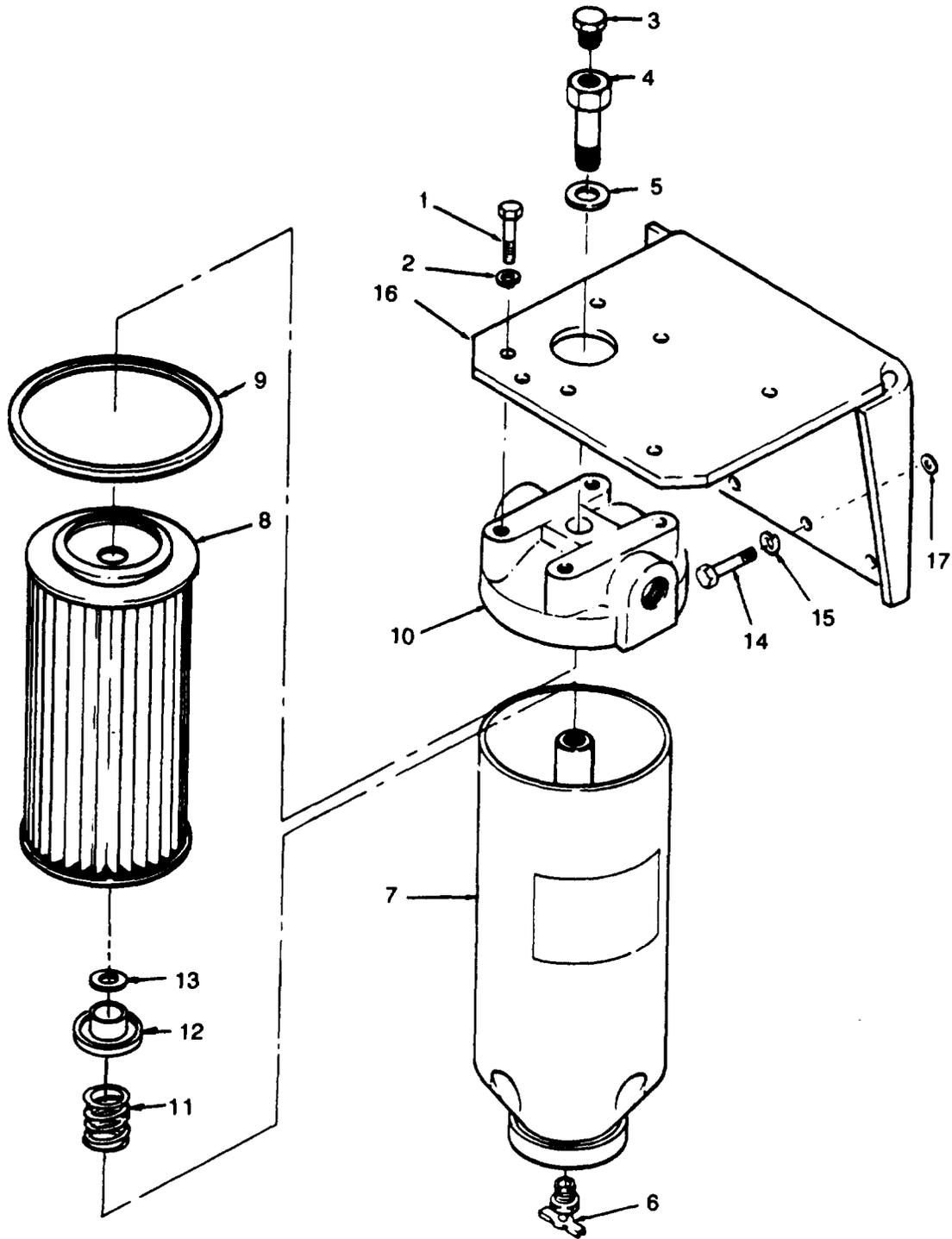

Figure 49. Secondary fuel filter.

TM 9-6115-465-24P
TO 35C2-3-446-4
NAVFAC P-8-625-24P
SL-4-06858B/06859D

(1) ILLUS- TRATION		(2) SMR CODE				(3)		(4)	(5) DESCRIPTION		(6)	(7)	(8)
a	b	a	b	c	d	a	b	NATIONAL STOCK NUMBER	REF NUMBER & MFR CODE	USABLE ON CODE	U/M	QTY INC IN UNIT	USMC QTY PER EQUIP
FIG NO.	ITEM NO.	ARMY	AIR FORCE	NAVY	USMC	SSI	REPL FACTOR						
49	1	PAOZZ	PAOZZ	PAGZZ	PAOZZ	D	.008	5305-00-269-3210	SCREW, CAPHEXAGON HEAD: FILTER MTG MS90725-59 96906		EA	2	
49	2	PAOZZ	PAOZZ	PAGZZ	PAOZZ	D	.010	5310-00-637-9541	WASHER, LOCK: FILTER MTG MS35308-46 96906		EA	2	
49		XBOZZ	PAOZZ	PAGGG	PAOOO	-	.008	2910-01-181-8461	FILTER, FUEL 70-2015 30554 3054-70-2015 36024		EA	1	1
49	3	PAOZZ	PAOZZ	PAOZZ	PAOZZ	D	.005	473000-537-1192	PLUG, PIPE: BLEEDER 72-2015-8 30554 104018 73370		EA	1	1
49	4	PAOZZ	PAOZZ	XBGZZ	PAOZZ	D	.006	4730-00-861-6890	SCREW, CAP: SPECIAL 104071 73370	CLA, CLB CLC, DGG	EA	1	1
49	4	PAOZZ	PAOZZ		PAOZZ				SCREW, CAP, HEXAGON HEAD 4920-82 02032	CZN, CZM	EA	1	1
49	5	PAOZZ	PAOZZ	PAOZZ	PAOZZ	-	.040	5310-00-630-2801	WASHER COPPER CENTER SCREW 70-507-3 36024		EA	1	2
49	6	PAOZZ	PAOZZ	PAGZZ	PAOZZ	D	.005	420-7529040	COCK DRAIN MS35782-4 96906		EA	1	4
49	7	XAOZZ	XAO	XAGZZ	XAOZZ	-	-		CAN, FILTER 30554-70-507-5 36024		EA	1	2
49	8	PAOZZ	PAOZZ	PAOZZ	PAOZZ	-	2.000	2910-00-287-1912	CARTRIDGE C1126PL 73370		EA	1	2
49	9	PAOZZ	PAOZZ	PAOZZ	PAOZZ	-	2.000	5330-00-663-4773	GASKET 101489 73370		EA	1	3
49	10	XAOZZ	XAO	XAGZZ	PAOZZ	-	-	2910-00-830-0154	HEAD 30554-72-2008 36024		EA	1	1
49	11	XBOZZ	XBO		XBOZZ				SPRING, TENSION 4920-87 02032	CZN	EA	1	2
49	12	PAOZZ	PAOZZ		PAOZZ	D	.008		SEALING PLATE 4920-89 02032	CZN	EA	1	2
49	13	PAOZZ	PAOZZ		PAOZZ	-	2.000	5330-00-187-3635	PACKING, PREFORMED 101488 73370	CZN	EA	1	2
49	14	PAOZZ	PAOZZ	PAGZZ	PAFZZ	D	.008	5305-00-269-3211	SCREW, CAPHEXAGON HEAD: BRACKET MTG MS90725-60 90906		EA	4	
49	15	PAOZZ	PAOZZ	PAOZZ	PAFZZ	D	.010	5310-00-637-9541	WASHER, LOCK MS353338-46 90906		EA	4	
49	16	XBOZZ	XBO	XBGZZ	XBFZZ	-	-		BRACKET 40-000364D 28265		EA	1	1
49	17	XBOZZ	XBO	PBFZZ	PAFZZ	-	-	5340-00-400-0076	SPACER 200087A 28265		EA	4	4

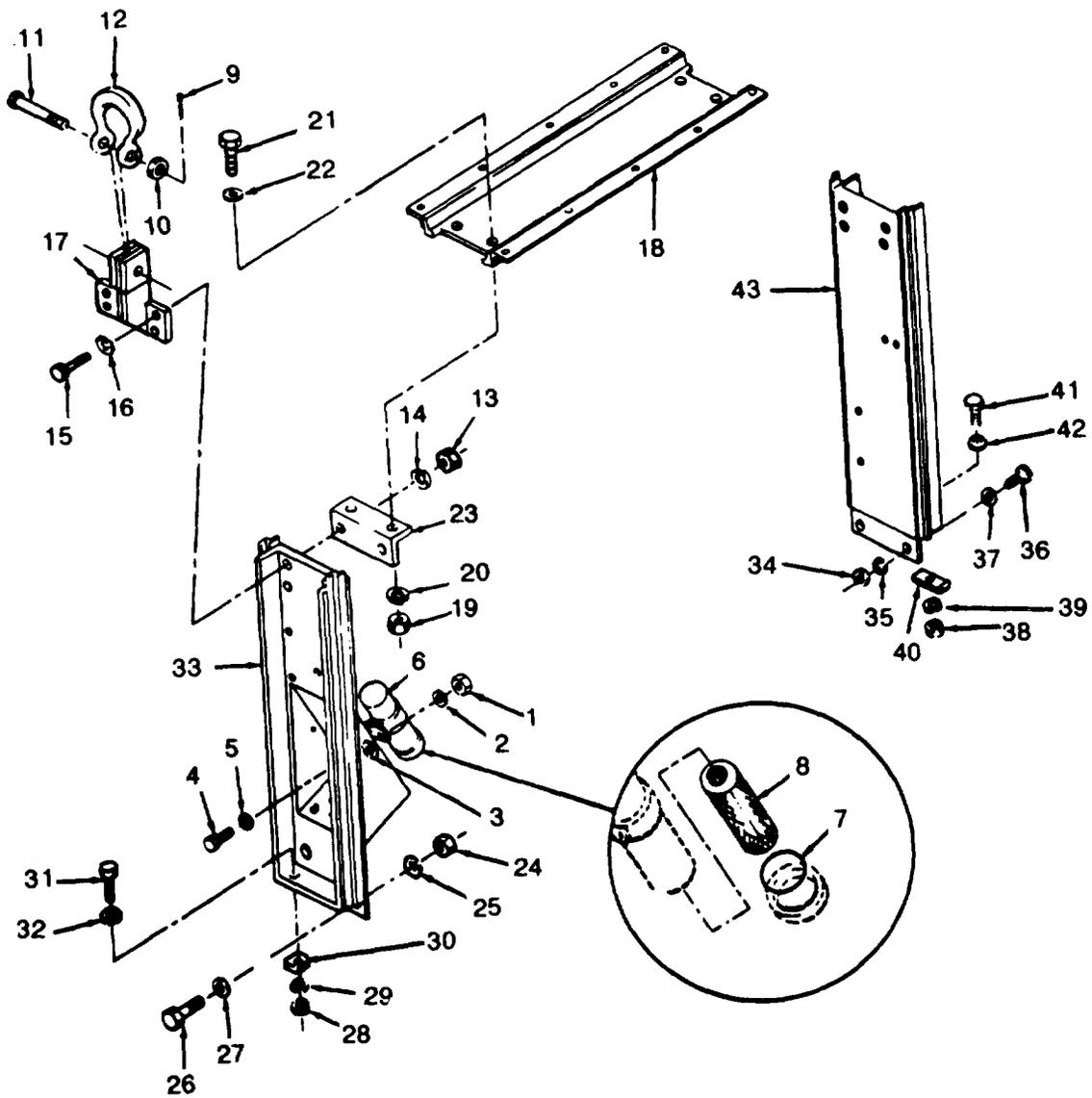

Figure 50. Center support and fuel pumps.

(1) ILLUSTRATION A FIG. NO.	(2) SMR CODE B AIR FORCE	(3) A SSI	(4) NATIONAL STOCK NUMBER	(5) DESCRIPTION REF NUMBER & MFR CODE	(6) USABLE ON CODE U/M	(7) QTY INC IN UNITS	(8) USMC QTY PER EQUIP					
								A	B	C	D	B REPL FACTOR
GROUP 16-CENTER SUPPORT												
50	1	PAOZZ	PAOZZ	PAGZZ	PAOZZ	D	.008	5310-00-761-6882	NUT,PLAIN,HEXAGON:FUEL PUMP MTG MS51967-2 96906	EA	4	109
50	2	PAOZZ	PAOZZ	PAGZZ	PAOZZ	D	.010	5310-00-582-5965	WASHER,LOCK:FUEL PUMP MTG MS35338-44 96906	EA	4	256
50	3	PAOZZ	PAOZZ		PAOZZ	D	.010	5310-00-067-6357	WASHER,LOCK MS45904-69 96906	CZM,EA	4	
50	4	PAOZZ	PAOZZ	PAGZZ	PAOZZ	D	.008	5305-00-068-0502	SCREW,CAP,HEXAGON HEAD:FUEL PUMP MTG MS90725-6 90906	EA	4	179
50	5	PAOZZ	PAOZZ	PAGZZ	PAOZZ	D	.010	5310-00-823-8804	WASHER,FLAT:FUEL PUMP MTG MS27183-9 96906	EA	4	45
50	6	PAOZZ	PAOZZ	PAHZZ	PAOZZ		.100	2910-01-095-7595	PUMP,FUEL 72-5313 30554	EA	2	2
50	7	PAOZZ	PAOZZ	PAHZZ	PAOZZ		.040	5330-00-763-9322	GASKET 479136 72850	EA	2	2
50	8	PAOZZ	PAOZZ	PAHZZ	PAFZZ		.050	2910-00-893-6402	STRAINER 479135 72850	EA	2	2
50	9	PAFZZ	XBZZ	XBZZ	PAFZZ			5315-00-298-1481	PIN,COTTER:CLEVIS SCREW MS24665-357 96906	EA	2	2
50	10	PAFZZ	XB	XBZZ	PAFZZ			5310-00-880-8186	NUT,PLAIN,HEXAGON:CLEVIS SCREW MS51967-26 96906	EA	2	2
50	11	PAFZZ	XB	XBZZ	XBZZ			5305-00-941-9317	SCREW,CAP,HEXAGON HEAD:CLEVIS MS51095-495 96906	EA	1	2
50	12	PAFZZ	XB	XBZZ	XBZZ				CLEVIS,LIFTING:GENERATOR 69-7812 30554 XBN8190 90202	EA	2	2
50	13	PAFZZ	PAOZZ	PAGZZ	PAFZZ	D	.008	5310-00-768-0318	NUT,PLAIN,HEXAGON:CLEVIS BRACKET MTG MS51967-14 96906	EA	8	20
50	14	PAFZZ	PAOZZ	PAGZZ	PAFZZ	D	.010	5310-00-584-5272	WASHER,LOCK:CLEVIS BRACKET MTG MS35338-48 96906	EA	8	41
50	15	PAFZZ	PAOZZ	PAGZZ	PAFZZ	D	.008	5305-00-042-6417	SCREW,CAP,HEXAGON HEAD:CLEVIS BRACKET MTG MS90725-113 90906	EA	8	20
50	16	PAFZZ	PAOZZ	PAGZZ	PAFZZ	D	.010	5310-00-809-5997	WASHER,FLAT:CLEVIS BRACKET MTG MS27183-17 96906	EA	8	21
50	17	XBZZ	XB	XBZZ	XBZZ				BRACKET,CLEVIS 72-7014 30554 30554-72-2014 36024	EA	2	2
50	18	XBZZ	XB	XBZZ	XBZZ				SUPPORT,CENTER:HOUSING ROOT 72-2013 30554 30554-72-2013 36024	EA	1	1
50	19	PAFZZ	PAOZZ	PAGZZ	PAFZZ	D	.008	5310-00-768-0318	NUT,PLAIN,HEXAGON:CENTER SUPPORT MTG MS51967-14 96906	EA	4	20
50	20	PAFZZ	PAOZZ	PAGZZ	PAFZZ	D	.010	5310-00-584-5272	WASHER,LOCK:CENTER SUPPORT MTG MS35338-48 96906	EA	4	41
50	21	PAFZZ	PAOZZ	PAGZZ	PAFZZ	D	.008	5305-00-042-6417	SCREW,CAP,HEXAGON HEAD:CENTER SUPPORT MTG MS90725-113 90906	EA	4	20

TM9-6115-465-24P
 TO 35C2-3-446-4
 NAVFAC P-8-625-24P
 SL-4-06858B/06859D

(1) ILLUSTRATION		(2) SMR CODE				(3)		(4) NATIONAL STOCK NUMBER	(5) DESCRIPTION	(6) USABLE ON CODE	(7) QTY INC IN UNITS	(8) USMC QTY PER EQUIP
A FIG. NO.	B ITEM NO.	A ARMY	B AIR FORCE	C NAVY	D USMC	A SSI	B REPL FACTOR	REF NUMBER & MFR CODE	U/M			
50	22	PAFZZ	PAOZZ	PAGZZ	PAFZZ	D	.010	5310-00-809-5997 WASHER,FLAT:CENTER SUPPORT MTG MS27183-17 96906	EA	4	21	
50	23	XBFZZ	XB	XBHZZ	XBFZZ			ANGLE,FRAME 72-7012 30554 30554-72-2012 36024	EA	2	2	
50	24	PAFZZ	PAOZZ	PAGZZ	PAFZZ	D	.008	5310-00-768-0318 NUT,PLAIN,HEXAGON:SIDE SUPPORT MTG MS51967-14 96906	EA	2	20	
50	25	PAFZZ	PAOZZ	PAGZZ	PAFZZ	D	.010	5310-00-584-5272 WASHER,LOCK:SIDE SUPPORT MTG MS35338-48 96906	EA	2	41	
50	26	PAFZZ	PAOZZ	PAGZZ	PAFZZ	D	.008	5305-00-042-6417 SCREW,CAP,HEXAGON HEAD:SIDE SUPPORT MTG MS90725-113 90906	EA	2	20	
50	27	PAFZZ	PAOZZ	PAGZZ	PAFZZ	D	.010	5310-00-809-5997 WASHER,FLAT:SIDE SUPPORT MTG MS27183-17 96906	EA	2	21	
50	28	PAFZZ	PAOZZ	PAGZZ	PAFZZ	D	.008	5310-00-768-0318 NUT,PLAIN,HEXAGON:SIDE SUPPORT MS51967-14 96906	EA	2	20	
50	29	PAFZZ	PAOZZ	PAGZZ	PAFZZ	D	.010	5310-00-584-5272 WASHER,LOCK:SIDE SUPPORT MTG MS35338-48 96906	EA	2	41	
50	30	PAFZZ	XB	XBHZZ	PAFZZ			5310-00-062-1475 WASHER,BEVEL:SIDE SUPPORT MTG 70-1531-2 30554 70-1531-2 52660	EA	2	6	
50	31	PAFZZ	PAOZZ	PAGZZ	PAFZZ	D	.008	5305-00-042-6417 SCREW,CAP,HEXAGON HEAD:SIDE SUPPORT MTG MS90725-113 90906	EA	2	2	
50	32	PAFZZ	PAOZZ	PAGZZ	PAFZZ	D	.010	5310-00-809-5997 WASHER,FLAT:SIDE SUPPORT MTG MS27183-17 96906	EA	2	21	
50	33	XBFZZ	XB	XBHZZ	XBFZZ			SUPPORT,LEFT:SIDE 72-7010 30554 30554-72-2010 36024	EA	1	1	
50	34	PAFZZ	PAOZZ	PAGZZ	PAFZZ	D	.008	5310-00-768-0318 NUT,PLAIN,HEXAGON:SIDE SUPPORT MTG MS51967-14 96906	EA	2	20	
50	35	PAFZZ	PAOZZ	PAGZZ	PAFZZ	D	.010	5310-00-584-5272 WASHER,LOCK:SIDE SUPPORT MTG MS35338-48 96906	EA	2	41	
50	36	PAFZZ	PAOZZ	PAGZZ	PAFZZ	D	.008	5305-00-042-6417 SCREW,CAP,HEXAGON HEAD:SIDE SUPPORT MTG MS90725-113 90906	EA	2	20	
50	37	PAFZZ	PAOZZ	PAGZZ	PAFZZ	D	.010	5310-00-809-5997 WASHER,FLAT:SIDE SUPPORT MTG MS27183-17 96906	EA	2	21	
50	38	PAFZZ	PAOZZ	PAGZZ	PAFZZ	D	.008	5310-00-768-0318 NUT,PLAIN,HEXAGON:SIDE SUPPORT MTG MS51967-14 96906	EA	2	20	
50	39	PAFZZ	PAOZZ	PAGZZ	PAFZZ	D	.010	5310-00-584-5272 WASHER,LOCK:SIDE SUPPORT MTG MS35338-48 96906	EA	2	41	
50	40	PAFZZ	XB	XBHZZ	PAFZZ			5310-00-062-1475 WASHER,BEVEL:SIDE SUPPORT MTG 70-1531-2 30554 70-1531-2 52660	EA	2		
50	41	PAFZZ	PAOZZ	PAGZZ	PAFZZ	D	.008	5305-00-042-6417 SCREW,CAP,HEXAGON HEAD:SIDE SUPPORT MTG MS90725-113 90906	EA	2	20	

TM9-6115-465-24P
 TO35CZ-3-446-4
 NAVFACP-8-625-24P
 SL-4-06858B/06859D

(1) ILLUSTRATION		(2) SMR CODE				(3)		(4) NATIONAL STOCK NUMBER	(5) DESCRIPTION	(6) USABLE ON CODE	(7) QTY INC IN UNITS	(8) USMC QTY PER EQUIP
A FIG. NO.	B ITEM NO.	A ARMY	B AIR FORCE	C NAVY	D USMC	A SSI	B REPL FACTOR	REF NUMBER & MFR CODE	U/M			
50	42	PAFZZ	PAOZZ	PAGZZ	PAFZZ	D	.010	5310-00-809-5997	WASHER, FLAT: SIDE SUPPORT MTG MS27183-17 96906	EA	2	21
50	43	XBFZZ	XB	XBHZZ	XBFZZ	-	-		SUPPORT, RIGHT 72-2011 30554 30554-72-2011 36024	EA	1	1

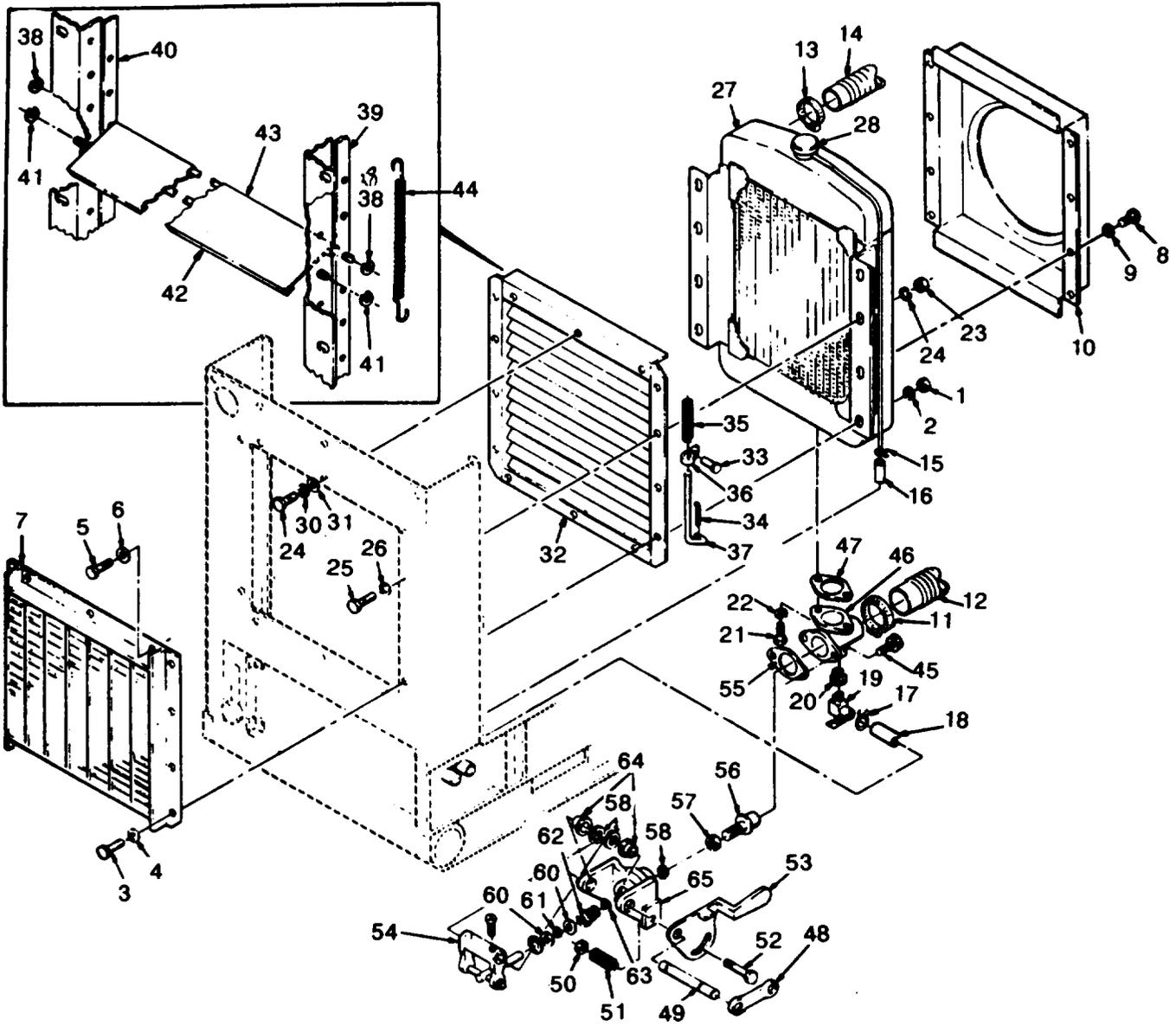

Figure 51. Radiator and shutter assembly.

(1) ILLUSTRATION A FIG. NO.	(2) SMR CODE B ITEM NO.	(3) A ARMY	(3) B AIR FORCE	(3) C NAVY	(3) D USMC	(3) E SSI	(4) NATIONAL STOCK NUMBER	(5) DESCRIPTION REF NUMBER & MFR CODE	(6) USABLE ON CODE	(6) U/M	(7) QTY INC IN UNITS	(8) USMC QTY PER EQUIP
GROUP 17 - COOLING GROUP												
51	1	PAOZZ	PAOZZ	PAOZZ	PAFZZ	D	.008 5310-00-732-0558	NUT, FLAIN, HEXAGON: RADIATOR AND GRILLE MTG MS51967-8 96906	EA		6	24
51	2	PAOZZ	PAOZZ	PAOZZ	PAFZZ	D	.010 5310-00-637-9541	WASHER, LOCK: RADIATOR AND GRILLE MTG MS35338-49 96906	EA		6	104
51	3	PAOZZ	PAOZZ	PAOZZ	PAFZZ	D	.008 5305-00-269-3209	SCREW, CAP, HEXAGON HEAD: RADIATOR AND GRILLE MTG MS90725-58 96906	EA		9	18
51	4	PAOZZ	PAOZZ	PAOZZ	PAFZZ	D	.010 5310-00-080-6004	WASHER, FLAT: RADIATOR AND GRILLE MTG MS27183-14 96906	EA		6	18
51	5	PAOZZ	PAOZZ	PAOZZ	PAFZZ	D	.008 5306-00-225-8497	BOLT, MACHINE: GRILLE MTG MS90725-32 96906	EA		4	44
51	6	PAOZZ	PAOZZ	PAOZZ	PAFZZ	D	.010 5310-00-584-5272	WASHER, LOCK: GRILLE MTG MS35338-48 96906	EA		4	41
51	7	XBOZZ	PAOZZ	XBHZZ	XBFZZ	-	-	GRILLE, RADIATOR 72-2202 30554 30554-72-2202 36024	EA		1	1
51	8	PAOZZ	PAOZZ	PAOZZ	PAOZZ	D	.008 5305-00-068-0502	SCREW, CAP, HEXAGON HEAD: SHROUD MTG MS90725-6 96906	EA		6	179
51	9	PAOZZ	PAOZZ	PAOZZ	PAOZZ	D	.010 5310-00-582-5965	WASHER, LOCK: SHROUD MTG MS35338-44 96906	EA		6	256
51	10	PFOZZ	PAOZZ	XBGZZ	XBOZZ	-	-	SHROUD, RADIATOR 72-2007 30554 30554-72-2007 36024	EA		1	1
51	11	PAOZZ	PAOZZ	PAGZZ	PAOZZ	D	.007 4730-00-909-8627	CLAMP, HOSE: LOWER RADIATOR MS35842-13 96906	EA		2	4
51	12	PAOZZ	PAOZZ	PAGZZ	PAOZZ	-	.070 4720-00-614-6230	HOSE, RADIATOR: LOWER 72-2056 30554 30554-72-2056 36024	EA		1	1
51	13	PAOZZ	PAOZZ	PAGZZ	PAOZZ	D	.007 4730-00-909-8627	CLAMP, HOSE: UPPER RADIATOR MS35842-13 96906	EA		2	4
51	14	PAOZZ	PAOZZ	PAGZZ	PAOZZ	-	.070 4720-00-627-9773	HOSE, RADIATOR: UPPER 72-2055 30554 30554-72-2055 36024	EA		1	1
51	15	PAOZZ	PAOZZ	PAGZZ	PAOZZ	D	.007 4730-00-063-7919	CLAMP, HOSE: RADIATOR OVERFLOW MS39326-8 96906	CLA, CLB CLC, CZN, CZM	EA	1	22
51	15	PAOZZ	PAOZZ		PAOZZ	D	.007 4730-00-103-2212	CLAMP, HOSE: RADIATOR OVERFLOW 72-2289-1 30554 A10S 05657	DGG	EA	1	22
51	16	MOOZZ	PAOZZ	MOOZZ	MOOZZ	-	4720-00-609-8732	HOSSE, RADIATOR: OVERFLOW 72-2110-6 30554 30554-72-2110-6 36024 MANUFACTURE FROM:	EA		1	1
51		PAOZZ	PAOZZ	PAGZZ	PAOZZ	-	.070 4730-00-278-4892	HOSE MILH13444TYPE1 (14 IN. REQUIRED)				
51	17	PAOZZ	PAOZZ	PAGZZ	PAOZZ	D	.007 4730-00-103-2212	CLAMP, HOSE: RADIATOR DRAIN 72-2289-1 30554	CLA, CLB, CLC, CZN, CZM	EA	1	22

(1) ILLUSTRATION A FIG. NO.	(2) SMR CODE B ITEM NO.	(3)				(4) NATIONAL STOCK NUMBER	(5) DESCRIPTION REF NUMBER & MFR CODE	(6) USABLE ON CODE U/M	(7) QTY INC IN UNITS	(8) USMC QTY PER EQUIP					
		A ARMY	B AIR FORCE	C NAVY	D USMC SSI										
51	17	PAOZZ	PAOZZ			PAOZZ	D	.007		4720-00-609-8733	CLAMP, HOSE: RADIATOR DRAIN 72-2289-1 30554 A10 06037	DGG	EA	1	2
51	18	MOOZZ	PAOZZ	MOOZ	MOOZZ		-	.070		4720-00-278-4892	HOSE, RADIATOR: DRAIN 72-2110-5 30554 30554-72-2110-5 36024 MANUFACTURE FROM:		EA	1	9
51		PAOZZ	PAOZZ	PAGZZ	PAOZZ		-	.070		4730-00-202-6491	HOSE MILH13444TYPE1 (11 IN. REQUIRED)				
51	19	PAOZZ	PAOZZ	PAOZZ	PAOZZ		D	.010		4730-00-202-6491	COCK, DRAIN: RADIATOR 72-2217 30554 6660 79470 3220X6X4		EA	1	1
51	20	PAOZZ	PAOZZ	PAFZZ	PAOZZ		D	.008		5305-00-269-3211	BUSHING 72-2026 30554 3220X6X4 79470		EA	1	
51	21	PAOZZ	PAOZZ	PAGZZ	PAFZZ		D	.008		5305-00-269-3211	SCREW, CAP, HEXAGON HEAD: WATER OUTLET TO RADIATOR MS90725-60 96906	CLA, CLB, CLC, CZN, CZM	EA	2	
51	21	PAOZZ	PAOZZ	PAGZZ	PAFZZ		D	.008		5305-00-269-3211	SCREW, CAP, HEXAGON HEAD: WATER OUTLET TO RADIATOR MS90725-80 96906	DGG	EA	2	
51	22	PAOZZ	PAOZZ	PAOZZ	PAFZZ		D	.010		5310-00-637-9541	WASHER, LOCK: WATER OUTLET TO RADIATOR MS35338-46 96906		EA	2	104
51	23	PAOZZ	PAOZZ	PAOZZ	PAFZZ		D	.008		5310-00-732-0558	NUT, PLAIN, HEXAGON: RADIATOR TO HOUSING MS51967-8 96906		EA	2	24
51	24	PAOZZ	PAOZZ	PAOZZ	PAFZZ		D			5310-00-637-9541	WASHER, LOCK: RADIATOR TO HOUSING MS35338-46 96906		EA	2	104
51	25	PAOZZ	PAOZZ	PAOZZ	PAFZZ		D	.008		5305-00-269-3209	SCREW, CAP, HEXAGON HEAD: RADIATOR TO HOUSING MS90725-58 96906		EA	2	18
51	26	PAOZZ	PAOZZ	PAOZZ	PAFZZ		D	.010		5310-00-080-6004	WASHER, FLAT: RADIATOR TO HOUSING MS27183-14 96906		EA	2	18
51	27	PBOFF	PBOZZ	PDDDG	PAFZZ		-	.010		2930-00-487-8900	RADIATOR, ENGINE COOLING 72-2002-2 30554 314384-200 67049		EA	1	1
51	28	PAOZZ	PAOZZ	PAOZZ	PAOZZ		-	.035		2930-00-720-2677	CAP, RADIATOR: FILL MS35840-1 96906		EA	1	1
51	29	PAOZZ	PAOZZ	PAOZZ	PAFZZ		D	.008		5306-00-225-8497	BOLT, MACHINE: SHUTTER TO HOUSING MS90725-32 96906		EA	2	44
51	30	PAOZZ	PAOZZ	PAOZZ	PAFZZ		D	.010		5310-00-407-9566	WASHER, LOCK: SHUTTER TO HOUSING MS35338-45 96906		EA	2	26
51	31	PAOZZ	PAOZZ	PAOZZ	PAFZZ		D	.010		5310-00-081-4219	WASHER, FLAT: SHUTTER MS27183-12 96906		EA	2	30
51		XBOZZ	PAOZZ	XBGGG	AFFFF		-	.051		2930-01-004-0012	SHUTTER, CONTROL: HEAT 72-2003 30554 1G407 96309		EA	1	1
51	32	XBOZZ	PBOZZ	XBGGG	PAFZZ		-	-		2930-01-024-9627	SHUTTER, RADIATOR 1G4070 96309		EA	1	

**TM 9-6115-465-24P
TO 35C2-3-446-4
NAVFAC P-8-625-24P
SL-4-06858B/06859D**

(1) ILLUS- TRATION		(2) SMR CODE				(3)		(4)	(5) DESCRIPTION		(6)	(7)	(8)
a	b	a	b	c	d	a	b	NATIONAL STOCK NUMBER	REF NUMBER & MFR CODE	USABLE ON CODE	U/M	QTY INC IN UNIT	USMC QTY PER EQUIP
FIG NO.	ITEM NO.	ARMY	AIR FORCE	NAVY	USMC	SSI	REPL FACTOR						
51	33	XBOZZ	PAOZZ	XBFZZ	XBFZZ	-	-		PIN 1A561 96309		EA	1	1
51		XBOZZ	PAOZZ	XBFZZ	AFFZZ	-	-		ROD ASSEMBLY 1G4074 96309		EA	1	1
51	34	PAOZZ	PAOZZ	XBFZZ	PAFZZ	D	.008	5315-00-839-2326	PIN, COTTER 1155 96309		EA	3	3
51	35	PAOZZ	PAOZZ	PAGZZ	PAFZZ	-	.015	5360-00-696-8522	SPRING 13622 96309		EA	1	1
51	36	XBOZZ	XA	XBGZZ	XBFZZ	-	-		BLOCK 136238 96309		EA	1	1
51	37	XBOZZ	PAOZZ	XBFZZ	XBFZZ	-	-		ROD 1G40704 96309		EA	1	1
51	38	PAOZZ	PAOZZ	PAFZZ	PAFZZ	D	.013	5365-00-263-3831	RING 1390 96309		EA	3	3
51	39	XBOZZ	MOO	XBFZZ	XBFZZ	-	-		BAR, CONTROL 1G40723L 96309		EA	1	1
51	40	XBOZZ	MOO	XBFZZ	XBFZZ	-	-		BAR, CONTROL		EA	1	1
51	41	PAOZZ	PADZZ	XBGZZ	PAFZZ	D	.013		RING, SNAP 1423 96309		EA	4	4
51	42	XBOZZ	XA	XBGZZ	XBFZZ	-	-		VANE ASSEMBLY 1G40721 96309		EA	1	1
51	43	XBOZZ	XA	XBGZZ	XBFZZ	-	-		FRAME ASSEMBLY 1G40720 96309		EA	1	1
51	44	PAOZZ	PAOZZ	PAGZZ	PAFZZ	-	.035	5360-00-812-8893	SPRING RETURN 1054 96309		EA	1	1
51	45	PAOZZ	PAOZZ	XBGZZ	PAFZZ	D	.008	5306-00-225-9093	BOLT, HEXAGON HEAD: WATER OUTLET TO FLANGE 1490 96309		EA	2	2
51	46	XBOZZ	XC	PAFZZ	PAFZZ	-	-	2930-00-401-9422	OUTLET, WATER 14801 96309		EA	1	1
51	47	PAOZZ	PAOZZ	PAGZZ	PAFZZ	-	.040	5330-00-251-4082	GASKET: WATER OUTLET 14803 21102		EA	1	1
51		XBFFZ	PAOZZ	XBGZZ	AFFFF	-	-		CONTROL ASSEMBLY 1G1771 96309		EA	1	1
51	48	XBFZZ	PAOZZ	PAGZZ	PAFZZ	D	.001	2930-00-192-9266	LEVER 1064-2 96309		EA	1	1
51	49	XBFZZ	MOO	XBGZZ	XBFZZ	-	-		SHAFT 28204 96309		EA	1	1
51	50	PAFZZ	PAOZZ	XBGZZ	PAFZZ	D	.008	5310-00-615-1829	NUT, PLAIN, HEXAGON 1399 96309		EA	1	1
51	51	PAFZZ	PAOZZ	PAGZZ	PAFZZ	D	.016	5360-00-343-3396	SPRING 13616 96309		EA	1	1
51	52	PAFZZ	PAOZZ	XBFZZ	PAFZZ	D	.008	5306-00-618-0709	BOLT, HEXAGON HEAD: HAND LEVER MTG 1490 96309		EA	1	1
51	53	XBFZZ	XA	XBGZZ	XBFZZ	-	-		LEVER, HAND 1017705 96309		EA	1	1

(1) ILLUSTRATION		(2) SMR CODE				(3)		(4) NATIONAL STOCK NUMBER	(5) DESCRIPTION	(6) USABLE ON CODE	(7) QTY INC IN UNITS	(8) USMC QTY PER EQUIP
A FIG. NO.	B ITEM NO.	A ARMY	B AIR FORCE	C NAVY	D USMC	A SSI	B REPL FACTOR	REF NUMBER & MFR CODE	U/M			
51	54	XBFZZ	XA	XBGZZ	XBFZZ	-	-	YOKE, PLUNGER 1107A 96309	EA	1	1	
51		XBFZZ	AFO	PAGGG	PAFFF	-	.700	6620-00-436-6575 ELEMENT, FLANGE 2492 96309	EA	1	1	
51	55	PAFZZ	PAOZZ	PAGZZ	PAFZZ	-	.040	5330-00-251-4082 GASKET 14803 96309	EA	1	1	
51	56	PAFZZ	PAOZZ	PAGZZ	PAFZZ	-	.050	2930-00-572-6148 ELEMENT, POWER 383 96309	EA	1	1	
51	57	PAFZZ	PAOZZ	PAGZZ	PAFZZ	D	.008	2930-00-860-0341 NUT, JAM 3903 96309	EA	1	1	
51	58	PAFZZ	PAOZZ	PAGZZ	PAFZZ	-	.030	5330-00-776-0580 PACKING, PREFORMED 3906 96309	EA	1	1	
51	59	PAFZZ	PAOZZ	PAGZZ	PAFZZ	D	.013	5365-00-252-4746 RING, RETAINING 3913 96309	EA	1	1	
51	60	XBFZZ	PAOZZ	PAGZZ	PAFZZ	D	.006	5340-00-118-3015 SEAT, SPRING 3912 96309	EA	2	2	
51	61	PAFZZ	PAOZZ	PAGZZ	PAFZZ	D	.020	5310-00-854-4342 WASHER, FELT 3914 96309	EA	1	1	
51	62	PAFZZ	PAOZZ	PAGZZ	PAFZZ	-	.015	2930-00-776-0491 SPRING 3910 96309	EA	1	1	
51	63	XBFZZ	PAOZZ	PAGZZ	PAFZZ	D	.006	2930-00-034-3802 SEAT, SPRING 3911 96309	EA	1	1	
51	64	XBFZZ	PAOZZ	PAGZZ	PAFZZ	D	.006	3120-00-547-4349 BUSHING 1028 96309	EA	2	2	
51	65	XBFZZ	XB	XBGZZ	XBFZZ	-	-	FLANGE 24902 96309	EA	1	1	

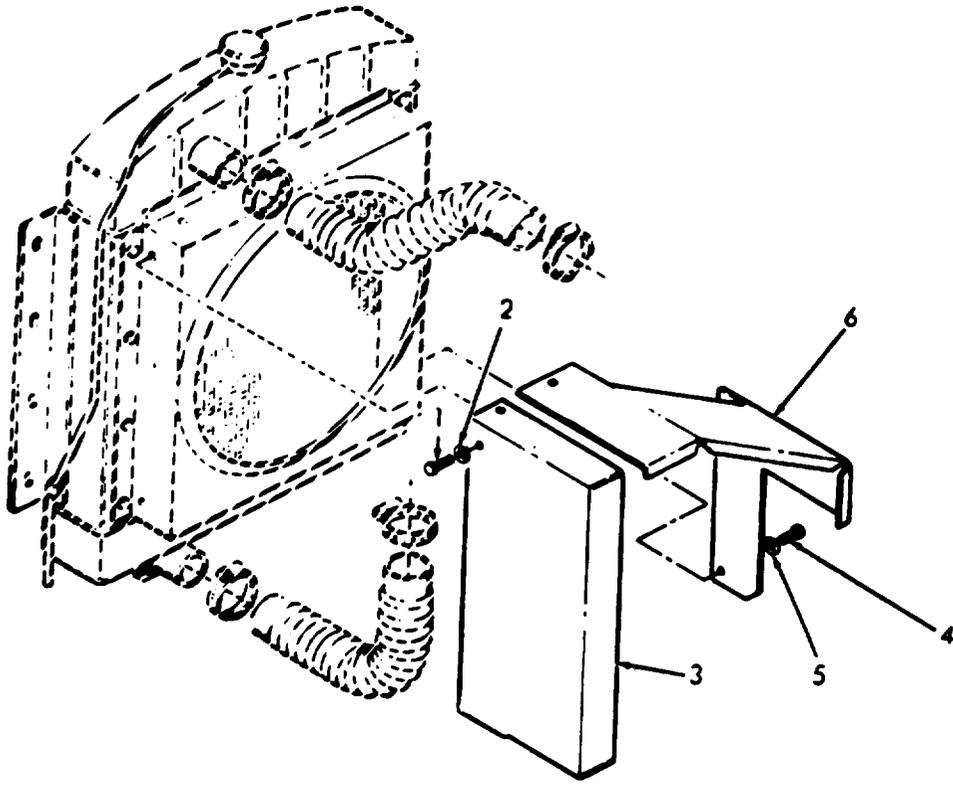

Figure 52. Fan guards.

TM9-6115-465-24P
 TO35CZ-3-446-4
 NAVFACP-8-625-24P
 SL-4-06858B/06859D

(1) ILLUSTRATION		(2) SMR CODE		(3)		(4) NATIONAL STOCK NUMBER	(5) DESCRIPTION	(6) USABLE ON CODE	(7) QTY INC IN UNITS	(8) USMC QTY PER EQUIP
A FIG. NO.	B ITEM NO.	A ARMY	B AIR FORCE	C NAVY	D USMC	A SSI	B REPL FACTOR	REF NUMBER & MFR CODE	U/M	
52	1	PAOZZ	PAOZZ	PAGZZ	PAOZZ	D	.008	5305-00-068-0500 SCREW, CAP, HEXAGON HEAD: GUARD MTG MS90275-3 96906	EA	4 179
52	2	PAOZZ	PAOZZ	PAGZZ	PAOZZ	D	.010	5310-00-582-5965 WASHER, LOCK: GUARD MTG MS35338-44 96906	EA	4 246
52	3	XBOZZ	XB	XBGZZ	XBOZZ	-	-	GUARD, FAN 72-2155 30554	EA	1 1
52	4	PAOZZ	PAOZZ	PAOZZ	PAOZZ	D	.008	5305-00-068-0500 SCREW, CAP, HEXAGON HEAD: GUARD MTG MS90275-3 96906	EA	4 179
52	5	PAOZZ	PAOZZ	PAGZZ	PAOZZ	D	.010	5310-00-582-5965 WASHER, LOCK: GUARD MTG MS35338-44 96906	EA	4 246
52	6	XBOZZ	XB	XBGZZ	XBOZZ	-	-	GUARD, FAN 72-2102 30554 30554-72-2102 36024	EA	1 1

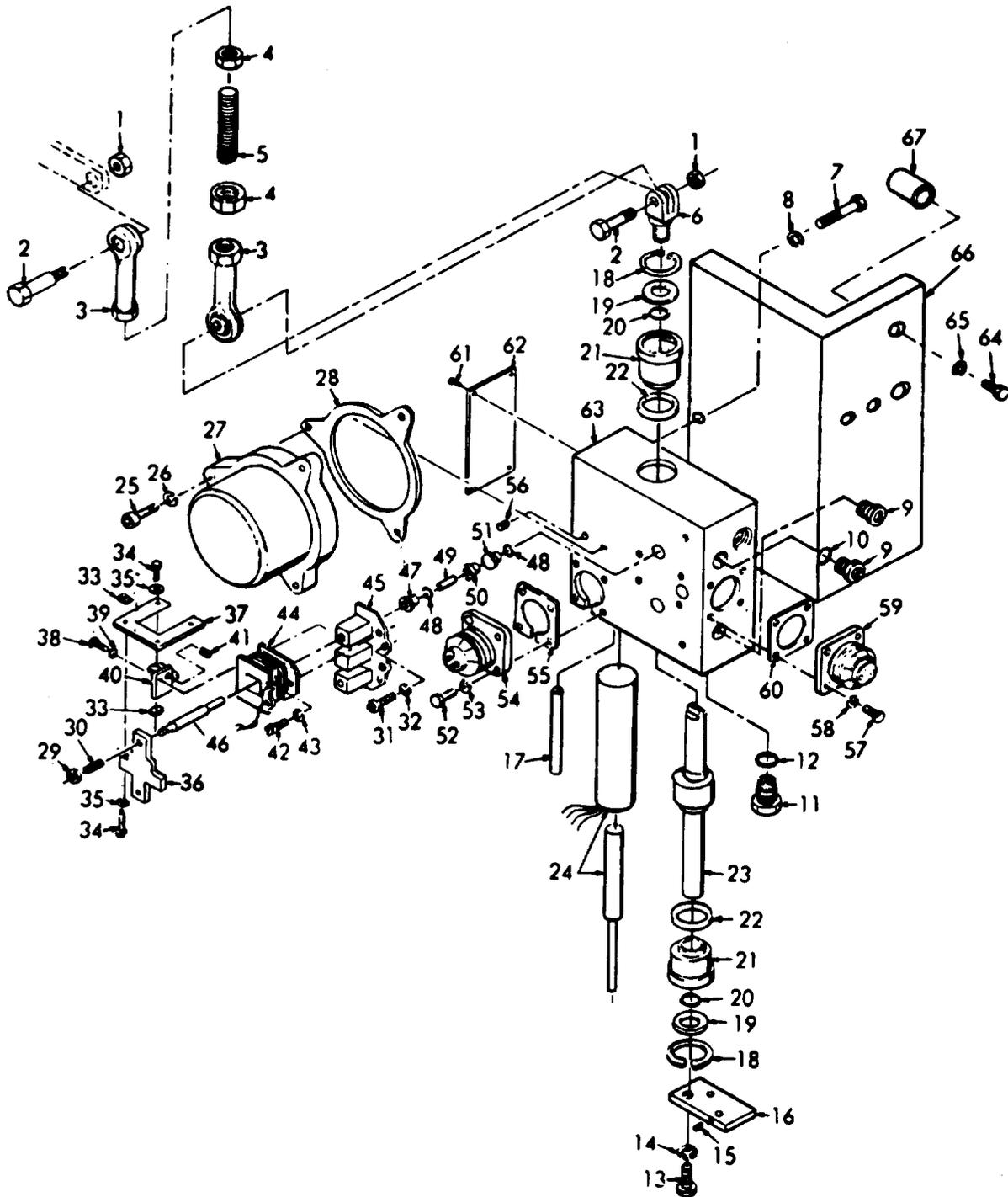

Figure 53. Hydraulic actuator unit.

(1) ILLUSTRATION		(2) SMR CODE				(3)		(4)	(5)	(6)	(7)	(8)	
A	B	A	B	C	D	A	B	NATIONAL STOCK NUMBER	DESCRIPTION	USABLE ON CODE	U/M	QTY INC IN UNITS	USMC QTY PER EQUIP
FIG. NO.	ITEM NO.	ARMY	AIR FORCE	NAVY	USMC	SSI	REPL FACTOR		REF NUMBER & MFR CODE				
GROUP 18 - HYDRAULIC ACTUATOR													
53	1	PAFZZ	PAOZZ	PAGZZ	PAFZZ	D	.008	5310-00-929-1807	NUT, PLAIN, HEXAGON MS51922-2 96906	CLB, CLC, CZM, DGG	EA	2	
53	2	PAFZZ	PAOZZ	PAGZZ	PAFZZ	D	.008	5305-00-207-8253	SCREW, CAP, HEXAGON HEAD MS35307-308 96906	CLB, CLC, CZM, DGG	EA	2	
53	3	XBFZZ	PAOZZ	PAGZZ	PAFZZ	-	-	3120-00-106-8645	ROD, END 70-2222 30554	CLB, CLC, CZM, DGG	EA	2	
53	4	PAFZZ	PAOZZ	PAGZZ	PAFZZ	D	.008	5310-00-043-0520	NUT, PLAIN, HEXAGON MS35650-3252 96906	CLB, CLC, CZM, DGG	EA	2	
53	5	XBFZZ	PAOZZ	XBGZZ	XBFZZ	-	-		ROD, THREADED 72-2120 30554 30554-72-2120 36024	CLB, CLC, CZM, DGG	EA	1	
53	6	XBFZZ	XB	XBGZZ	PAFZZ	-	-	5340-00-095-6789	CLEVIS, ROD 69-698 30554 30554-69-698 36024	CLB, CLC, CZM, DGG	EA	1	
53	7	PAFZZ	PAOZZ	PAOZZ	PAFZZ	D	.008	5305-00-068-0502	SCREW, CAP, HEXAGON HEAD: ACTUATOR MTG MS90725-6 96906	CLB, CLC, CZM, DGG	EA	4	
53	8	PAFZZ	PAOZZ	PAOZZ	PAFZZ	D	.010	5310-00-582-5965	WASHER, LOCK: ACUTATOR MTG MS35338-44 96906	CLB, CLC, CZM, DGG	EA	4	
53		PAFFH	PAOFF	PBGGG	PAFHH	-	.250	2990-00-216-9983	ACTUATOR UNIT 69-790-3 30554	CLB, CLC,	EA	1	
53		PAFFH	PAOFF		PAFHH	-	.250	2990-00-405-6146	ACTUATOR UNIT 69-600-2 30554	CZM, DGG	EA	1	
53	9	XBFZZ	XB	XBGZZ	XBHZZ	-	-		PLUG, O RING 69-633 30554 7238X2 79470	CLB, CLC, CZM, DGG	EA	2	
53	10	PAFZZ	PAOZZ	PAGZZ	PAHZZ	-	.030	5330-00-584-1040	PACKING, PREFORMED MS9020-02 96906	CLB, CLC, CZM, DGG	EA	6	
53	11	PAFZZ	PAOZZ	PAGZZ	PAHZZ	-	.050	2990-00-211-5258	FILTER ASSEMBLY 69-622 30554	CLB, CLC, CZM, DGG	EA	1	
53	12	PAFZZ	PAOZZ	PAGZZ	PAHZZ	-	.030	5330-00-067-3358	PACKING, PREFORMED AN6227-12 88044	CLB, CLC, CZM, DGG	EA	1	
53	13	PAFZZ	PAOZZ	XBOZZ	PAHZZ	D	.008	5305-00-225-3839	SCREW, MACHINE MS90725-8 96906	CLB, CLC, CZM, DGG	EA	1	
53	14	PAFZZ	PAOZZ	PAOZZ	PAHZZ	D	.010	5310-00-582-5965	WASHER, LOCK MS35338-44 96906	CLB, CLC, CZM, DGG	EA	1	
53	15	PAFZZ	PAOZZ	PAGZZ	PAHZZ	D	.008	5305-00-969-4348	SETSCREW MS18066-11 96906	CLB, CLC, CZM, DGG	EA	1	
53	16	XBFZZ	XB	XBGZZ	XBHZZ	-	-		LINK 69-625 30554	CLB, CLC, CZM, DGG	EA	1	
53	17	XBFZZ	XB	PAFZZ	PAHZZ	D	.013	5315-00-843-9743	PIN, SPRING MS171572 96906	CLB, CLC, CZM, DGG	EA	1	
53	18	PAFZZ	PAOZZ	PAGZZ	PAHZZ	D	.013	5365-00-833-7454	RING, RETAINING MS16625-1093 96906	CLB, CLC, CZM, DGG	EA	2	
53	19	XBFZZ	XB	XBGZZ	PAHZZ	-	-	5310-00-303-0080	WASHER 69-602 30554	CLB, CLC, CZM, DGG	EA	2	

(1) ILLUSTRATION		(2) SMR CODE				(3)		(4)	(5)	(6)	(7)	(8)	
A	B	A	B	C	D	A	B	NATIONAL STOCK NUMBER	DESCRIPTION	USABLE ON CODE	U/M	QTY INC IN UNITS	USMC QTY PER EQUIP
FIG. NO.	ITEM NO.	ARMY	AIR FORCE	NAVY	USMC	SSI	REPL FACTOR		REF NUMBER & MFR CODE				
53	20	PAFZZ	PAOZZ	PAGZZ	PAHZZ	-	.030	5330-00-357-2064	O RING ASSEMBLY 69-632 30554 KIN5112-8112 07322	CLB,CLC, CZM,DGG	EA	2	
53	21	PAFZZ	PAOZZ	PAGZZ	PAHZZ	D	.005	3120-00-212-0061	COLLAR 69-601 30554	CLB,CLC, CZM,DGG	EA	2	
53	22	PAFZZ	XB	XBGZZ	PAHZZ	D	.008	5330-00-316-7248	QUAD-RING 69-610 30554	CLB,CLC, CZM,DGG	EA	2	
53	23	PAFZZ	PAOZZ	PAGZZ	PAHZZ	D	.005	2990-00-211-5086	PISTON 69-624 30554	CLB,CLC, CZM,DGG	EA	1	
53	24	PAFZZ	PAOZZ	PBGZZ	PAHZZ	-	.050	6625-00-190-4868	TRANSDUCER ASSEMBLY 69-629 30554	CLB,CLC, CZM,DGG	EA	1	
53	25	PAFZZ	PAOZZ	PAGZZ	PAHZZ	D	.008	5305-00-958-6517	SCREW, CAP, SOCKET HEAD: COVER MTG MS16996-12 96906	CLB,CLC, CZM,DGG	EA	3	
53	26	PAFZZ	PAOZZ	PAGZZ	PAHZZ	D	.010	5310-00-045-3296	WASHER, LOCK: COVER MTG MS35338-43 96906	CLB,CLC, CZM,DGG	EA	3	
53	27	XBFZZ	XB	XBOZZ	PAHZZ	-	-	2990-00-021-5241	COVER 69-616 30554	CLB,CLC, CZM,DGG	EA	1	
53	28	PAFZZ	PAOZZ	PAGZZ	PAHZZ	-	.030	5330-00-211-9920	GASKET: COVER 69-606 30554	CLB,CLC, CZM,DGG	EA	1	
53	29	PAFZZ	PAOZZ	PAGZZ	PAHZZ	D	.008	5310-00-934-9747	NUT, PLAIN, HEXAGON MS35649-262 96906	CLB,CLC, CZM,DGG	EA	2	
53	30	PAFZZ	PAOZZ	PAGZZ	PAHZZ	D	.008	5305-00-058-9365	SETSCREW MS51977-22 96906	CLB,CLC, CZM,DGG	EA	2	
53	31	PAFZZ	PAOZZ	PAGZZ	PAHZZ	D	.008	5305-00-531-0298	SCREW, MACHINE MS35265-15 96906	CLB,CLC, CZM,DGG	EA	4	
53	32	PAFZZ	PAOZZ	PAGZZ	PAHZZ	D	.010	5310-00-543-2410	WASHER, LOCK MS35338-40 96906	CLB,CLC, CZM,DGG	EA	4	
53		XBFZZ	XB	PBGZZ	AHHZZ	-	-	2990-00-211-5249	CORE, ARMATURE 69-618 30554	CLB,CLC, CZM,DGG	EA	1	
53	33	PAFZZ	PAOZZ	PAGZZ	PAHZZ	D	.008	5310-00-982-4933	NUT, SQUARE MS27040-4 96906	CLB,CLC, CZM,DGG	EA	4	
53	34	PAFZZ	PAOZZ	PAGZZ	PAHZZ	D	.008	5305-00-978-9343	SCREW, CAP, SOCKET HEAD MS16997-10 96906	CLB,CLC, CZM,DGG	EA	4	
53	35	PAFZZ	PAOZZ	PAGZZ	PAHZZ	D	.010	5310-00-933-8118	WASHER, LOCK MS35338-135 96906	CLB,CLC, CZM,DGG	EA	8	
53	36	XBFZZ	XB	XBGZZ	XBHZZ	-	-		ARMATURE 69-620 30554	CLB,CLC, CZM,DGG	EA	1	
53	37	XBFZZ	XB	XBGZZ	PAHZZ	-	-	5360-00-267-0777	SPRING 69-609 30554	CLB,CLC, CZM,DGG	EA	1	
53	38	PAFZZ	PAOZZ	PAGZZ	PAHZZ	D	.008	5305-00-978-9342	SCREW, CAP, HEXAGON HEAD MS16997-9 96906	CLB,CLC, CZM,DGG	EA	4	
53	39	PAFZZ	PAOZZ	PAGZZ	PAHZZ	D	.010	5310-00-933-8118	WASHER, LOCK MS35338-135 96906	CLB,CLC, CZM,DGG	EA	8	
53	40	XBFZZ	XB	XBGZZ	XBHZZ	-	-		BRACKET, ADJUSTING 69-621 30554	CLB,CLC, CZM,DGG	EA	2	

(1) ILLUSTRATION		(2) SMR CODE				(3)			(4) NATIONAL STOCK NUMBER	(5) DESCRIPTION	(6) USABLE ON CODE	(7) QTY INC IN UNITS	(8) USMC QTY PER EQUIP
A FIG. NO.	B ITEM NO.	A ARMY	B AIR FORCE	C NAVY	D USMC	A SSI	B REPL FACTOR		REF NUMBER & MFR CODE	U/M			
53	41	XBFZZ	XB	XBGZZ	PAHZZ	-	-	5315-00-291-5471	PIN, SPRING MS171431 96906	CLB, CLC, CZM, DGG	EA	4	
53	42	PAFZZ	PAOZZ	PAGZZ	PAHZZ	D	.008	5305-00-579-2138	SCREW, MACHINE MS35265-2 96906	CLB, CLC, CZM, DGG	EA	4	
53	43	PAFZZ	PAOZZ	PAGZZ	PAHZZ	D	.010	5310-00-543-5060	WASHER, LOCK MS35338-39 96906	CLB, CLC, CZM, DGG	EA	4	
53	44	PAFZZ	PAOZZ	PAHZZ	PAHZZ	D	.005	5950-00-211-2000	COIL ASSEMBLY 69-630 30554	CLB, CLC, CZM, DGG	EA	2	
53	45	XBFZZ	XB	XBGZZ	XBHZZ	-	-		CORE, 69-619 30554	CLB, CLC, CZM, DGG	EA	1	
53	46	PAFZZ	PAOZZ	PAGZZ	PAHZZ	-	.023	2910-00-212-9065	NEEDLE VALVE 69-608 30554	CLB, CLC, CZM, DGG	EA	2	
53	47	XBFZZ	XB	XBGZZ	PAHZZ	-	-	4730-00-285-4329	ORIFICE, ROP 69-605 30554	CLB, CLC, CZM, DGG	EA	2	
53	48	PAFZZ	PAOZZ	PAGZZ	PAHZZ	-	.030	5330-00-584-1040	PACKING, PREFORMED MS9020-02 96906	CLB, CLC, CZM, DGG	EA	6	
53	49	PAFZZ	PAOZZ	PAGZZ	PAHZZ	-	.023	2990-00-211-5066	VALVE 69-617 30554	CLB, CLC, CZM, DGG	EA	2	
53	50	XBFZZ	XB	XBGZZ	XBHZZ	-	-		SPACER 69-604 30554	CLB, CLC, CZM, DGG	EA	2	
53	51	XBFZZ	XB	XBGZZ	PAHZZ	-	-	4730-00-287-8473	ORIFICE, BOTTOM 69-603 30554	CLB, CLC, CZM, DGG	EA	2	
53	52	PAFZZ	PAOZZ	PAGZZ	PAHZZ	D	.008	5305-00-543-2732	SCREW, MACHINE MS35265-18 96906	CLB, CLC, CZM, DGG	EA	4	
53	53	PAFZZ	PAOZZ	PAGZZ	PAHZZ	D	.010	5310-00-543-2410	WASHER, LOCK MS35338-40 96906	CLB, CLC, CZM, DGG	EA	4	
53	54	PAFZZ	PAOZZ	PAGZZ	PAHZZ	D	.024	5935-00-800-2824	CONNECTOR, RECEPTACLE MS3102R14S-2S 96906	CLB, CLC, CZM, DGG	EA	1	
53	55	XBFZZ	XB	XBGZZ	PAHZZ	-	-	5365-00-536-6677	SPACER 69-612 30554	CLB, CLC, CZM, DGG	EA	1	
53	56	PAFZZ	PAOZZ	PAGZZ	PAHZZ	D	.008	5305-00-782-7189	SETSCREW MS51967-37 96906	CLB, CLC, CZM, DGG	EA	1	
53	57	PAFZZ	PAOZZ	PAGZZ	PAHZZ	D	.008	5305-00-614-0260	SCREW, MACHINE MS35265-17 96906	CLB, CLC, CZM, DGG	EA	4	
53	58	PAFZZ	PAOZZ	PAGZZ	PAHZZ	D	.010	5310-00-543-2410	WASHER, LOCK MS35338-40 96906	CLB, CLC, CZM, DGG	EA	4	
53	59	PAOFZZ	PAOZZ	PAGZZ	PAHZZ	D	.023	5935-00-557-2054	CONNECTOR, RECEPTACLE 172-31485P2 29587	CLB, CLC, CZM, DGG	EA	1	
53	60	PAFZZ	PAOZZ	PAGZZ	PAHZZ	-	.030	5330-00-213-8901	GASKET 69-607 30554	CLB, CLC, CZM, DGG	EA	1	
53	61	PAFZZ	PAOZZ	PAGZZ	PAHZZ	D	.008	5305-00-253-5603	SCREW, DRIVE MS21318-1 96906	CLB, CLC, CZM, DGG	EA	4	
53	62	XBFZZ	XB	XBGZZ	MDOZZ	-	-		PLATE, IDENTIFICATION 69-615 30554	CLB, CLC, CZM, DGG	EA	1	
53	63	XBFZZ	XB	XBGZZ	XBHZZ	-	-		BLOCK, VALVE 69-631 30554	CLB, CLC, CZM, DGG	EA	1	

TM9-6115-465-24P
 TO35CZ-3-446-4
 NAVFACP-8-625-24P
 SL-4-06858B/06859D

(1) ILLUSTRATION		(2) SMR CODE				(3)		(4) NATIONAL STOCK NUMBER	(5) DESCRIPTION	(6) USABLE ON CODE	(7) QTY INC IN UNITS	(8) USMC QTY PER EQUIP
A FIG. NO.	B ITEM NO.	A ARMY	B AIR FORCE	C NAVY	D USMC	A SSI	B REPL FACTOR	REF NUMBER & MFR CODE	U/M			
53	64	PAFZZ	PAOZZ	PAGZZ	PAHZZ	D	.008	5305-00-716-8128	SCREW, CAP, HEXAGON HEAD: ACTUATOR BRACKET MTG MS90725-117 96906	CLB,CLC, CZM,DGG	EA	1
53	65	PAFZZ	PAOZZ	PAOZZ	PAHZZ	D	.008	5310-00-584-5272	WASHER, LOCK: ACTUATOR BRACKET MTG MS35338-48 96906	CLB,CLC, CZM,DGG	EA	2
53	66	XBFZZ	XB	XBGZZ	XBHZZ	-	-	BRACKET, ACTUATOR 75-0850 30554 30554-75-0850 36024	CZM,DGG	EA	1	
53	66	XBFZZ	XB	XBGZZ	XBHZZ	-	-	BRACKET, ACTUATOR 72-2109 30554 30554-72-2109 36024	CLB,CLC	EA	1	
53	67	XBFZZ	XB	XBGZZ	XBHZZ	-	-	SPACER, ACTUATOR 72-2099-2 30554	CLB,CLC,	EA	2	
53	67	XBFZZ	XB		XBHZZ	-	-	SPACER 72-2099-3 30554	CZM,DGG	EA	2	

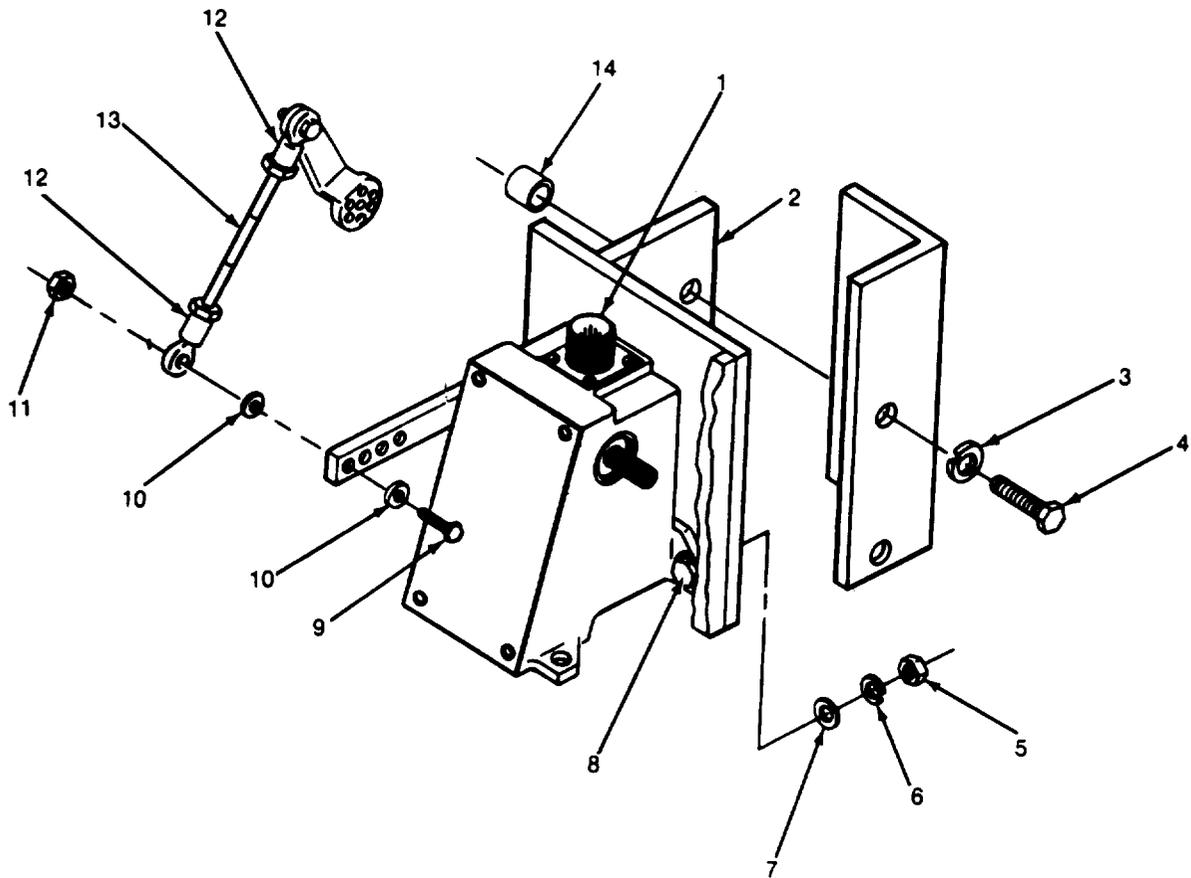

Figure 54. Actuator Electric Governor.

TM9-6115-465-24P
 TO35CZ-3-446-4
 NAVFACP-8-625-24P
 SL-4-06858B/06859D

(1) ILLUSTRATION		(2) SMR CODE			(3)			(4) NATIONAL STOCK NUMBER	(5) DESCRIPTION	(6) USABLE ON CODE	(7) QTY INC IN UNITS	(8) USMC QTY PER EQUIP
A FIG. NO.	B ITEM NO.	A ARMY	B AIR FORCE	C NAVY	D USMC	A SSI	B REPL FACTOR	REF NUMBER & MFR CODE	U/M			
54	1	PAFZZ			PAFZZ			ACTUATOR, ELECTRIC GOVERNOR 81-705 30554	CLC	EA	1	
54	2	PAFZZ			PAFZZ			BRACKET ACTUATOR MOUNTING 81-704 30554	CLC	EA	1	
54	3	PAFZZ			PAFZZ		5310-00-584-5272	WASHER, LOCK MS35338-48 96906	CLC	EA	2	
54	4	PAFZZ			PAFZZ		5305-00-042-6417	SCREW, CAP, HEX HD MS90725-113 96906	CLC	EA	2	
54	5	PAFZZ			PAFZZ		5310-00-997-1888	NUT, PLAIN MS35649-2252 96906	CLC	EA	2	
54	6	PAFZZ			PAFZZ		5310-00-582-5965	WASHER, LOCK MS35338-44 96906	CLC	EA	2	
54	7	PAFZZ			PAFZZ		5310-00-809-4058	WASHER, FLAT MS27188-10 96906	CLC	EA	2	
54	8	PAFZZ			PAFZZ		5305-00-071-2241	SCREW, CAP MS90725-10 96906	CLC	EA	2	
54	9	PAFZZ			PAFZZ		5305-00-021-3668	SCREW, CAP, HEX HD MS35307-310 96906	CLC	EA	2	
54	10	PAFZZ			PAFZZ		5310-00-582-5677	WASHER, FLAT MS15975-810 96906	CLC	EA	4	
54	11	PAFZZ			PAFZZ		5310-00-924-1807	NUT, SELF-LOCKING MS51922-2 96906	CLC	EA	2	
54	12	PAFZZ			PAFZZ		3120-00-106-8645	BEARING PLAIN ROD 70-1111 30554	CLC	EA	2	
54	13	PAFZZ			PAFZZ			ROD, CONTINUOUS THRD 72-2120 30554	CLC	EA	1	

(1) ILLUSTRATION		(2) SMR CODE				(3)			(4) NATIONAL STOCK NUMBER	(5) DESCRIPTION	(6) USABLE ON CODE	(7) QTY INC IN UNITS	(8) USMC QTY PER EQUIP
A FIG. NO.	B ITEM NO.	A ARMY	B AIR FORCE	C NAVY	D USMC	A SSI	B REPL FACTOR		REF NUMBER & MFR CODE	U/M			
GROUP 19 - HYDRAULIC SUMP AND FILTER													
55	1	MFOHZ	PAOZZ	AGGZZ	AFOZZ	-	-		HOSE ASSEMBLY: ACTUATOR TO TANK MS28741-6-0320 96906 MANUFACTURE FROM:	CLB, CLC, CZM, DGG	EA	1	
55	2	PAFZZ	PAOZZ	PAGZZ	PAFZZ	D	.047	4730-00-843-0269	FITTING MS24587-6 96906	CLB, CLC, CZM, DGG	EA	2	
55	3	PAFZZ	PAOZZ	PAGZZ	PAFZZ	D	.070	4720-00-278-1323	HOSE MILH8794-6 81349	CLB, CLC, CZM, DGG	FT	3	
55	4	MFOHZ	MOO	XBOZZ	AFOZZ	-	-		TUBE, HYDRAULIC OIL: PUMP TO TANK 72-2163 30554 30554-72-2163 36024	CLB, CLC, CZM, DGG	EA	1	
55	5	PAFZZ	PAOZZ	PAGZZ	PAFZZ	D	.047	4730-01-100-6990	NUT, TUBE COUPLING 72-2052-2 30554 C5115X6 79470	CLB, CLC, CZM, DGG	EA	1	
55	6	PAFZZ	PAOZZ	PAOZZ	PAFZZ	D	.030	4710-00-278-8726	TUBE WWT700-4DIA375 81349	CLB, CLC, CZM, DGG	FT	5	
55	7	MFOHZ	PAOZZ	AGGGG	AFOZZ	-	-	4720-00-289-4476	HOSE ASSEMBLY, OIL: ACTUATOR TO FILTER MS28741-6-0120 96906	CLB, CLC, CZM, DGG	EA	1	
55	8	PAFZZ	PAOZZ	PAGZZ	PAFZZ	D	.047	4730-00-843-0269	FITTING MS24587-6 96906	CLB, CLC, CZM, DGG	EA	2	
55	9	PAFZZ	PAOZZ	PAGZZ	PAFZZ	D	.070	4720-00-278-1323	HOSE MILH8794-6 81349	CLB, CLC, CZM, DGG	FT	1	
55	10	PAOZZ	PAOZZ	PAOZZ	PAOZZ	D	.008	5340-00-725-5279	CLAMP, LOOP: HOSE MS21333-50 96906	CLB, CLC, CZM, DGG	EA	1	
55	11	MFOHZ	PAOZZ	AGGGG	AFOZZ	-	-		HOSE ASEMBLY, OIL: PUMP TO FILTER MS28741-6-0160 96906	CLB, CLC, CZM, DGG	EA	1	
55	12	PAFZZ	PAOZZ	PAGZZ	PAFZZ	D	.047	4730-00-843-0269	FITTING, HOSE MS24587-6 96906	CLB, CLC, CZM, DGG	EA	2	
55	13	PAFZZ	PAOZZ	PAGZZ	PAFZZ	D	.070	4720-00-278-1323	HOSE MILH8794-6 81349	CLB, CLC, CZM, DGG	FT	2	
55	14	PAFZZ	PAOZZ	PAGZZ	PAFZZ	D	.006	4730-00-816-6748	ELBOW MS51815-36 96906	CLB, CLC, CZM, DGG	EA	2	
55	15	PAOZZ	PAOZZ		PAFZZ	D	.006	4730-00-778-6286	ELBOW, MALE: ACTUATOR MS51527B6 96906	CLB, CLC, CZM, DGG	EA	2	
55	16	PAOZZ	PAOZZ		PAFZZ	-	.030	5330-00-804-5965	PACKING, PREFORMED: ELBOW MTG MS28778-6 96906	CLB, CLC, CZM, DGG	EA	2	
55	17	PAFZZ	PAOZZ	XBOZZ	PAFZZ	D	.047	4730-00-614-6473	NUT, TUBE: ELBOW MTG MS39321V6 96906	CLB, CLC, CZM, DGG	EA	2	
55	18	PAFZZ	PAOZZ	PAGZZ	PAFZZ	D	.006	4730-00-331-4686	ELBOW MS51504B8-4 96906	DGG	EA	2	
55	18	PAFZZ	PAOZZ	PAGZZ	PAFZZ	D	.006	4730-00-088-8901	ELBOW 72-2168-2 30554 6-6CTX-S 30780	CLB, CLC, CZM	EA	2	
55	19	PAFZZ	PAOZZ	PAGZZ	PAFZZ	D	.047		ADAPTER C52554X4 79470	CLB, CLC, CZM	EA	2	

TM9-6115-465-24P
 TO35CZ-3-446-4
 NAVFACP-8-625-24P
 SL-4-06858B/06859D

(1) ILLUSTRATION		(2) SMR CODE			(3)			(4) NATIONAL STOCK NUMBER	(5) DESCRIPTION	(6) USABLE ON CODE	(7) QTY INC IN UNITS	(8) USMC QTY PER EQUIP
A FIG. NO.	B ITEM NO.	A ARMY	B AIR FORCE	C NAVY	D USMC	A SSI	B REPL FACTOR	REF NUMBER & MFR CODE	U/M			
55	20	PAFZZ	PAOZZ		PAFZZ	D	.047	ADAPTER 72-2023-1 30554	DGG EA	1	3	
55	21	PAFZZ	XA		PAFZZ	D	.047	ADAPTER 72-2023-2 3-554	DGG EA	1		
55	22	PAFZZ	PAOZZ		PAFZZ	-	.030	5330-00-805-2966 O RING MS28778-4 96906	DGG EA	2		
55	23	PAFZZ	PAOZZ		PAFZZ	-	.030	5330-00-833-7491 O RING MS28778-5 96906	CLB, CLC, CZM, DGG EA	1		
55	24	PAFZZ	PAOZZ		PAFZZ	D	.006	4730-00-812-7999 ELBOW, 90 DEG. PUMP 70-1109-37 30554 6-CTX-S 30780	DGG EA	2		
55	24	PAFZZ	PAOZZ	PAGZZ	PAFZZ	D	.006	4730-00-451-6098 ELBOW, 90 DEG. PUMP MS51815-37 96906	CLB, CLC, CZM EA	2		

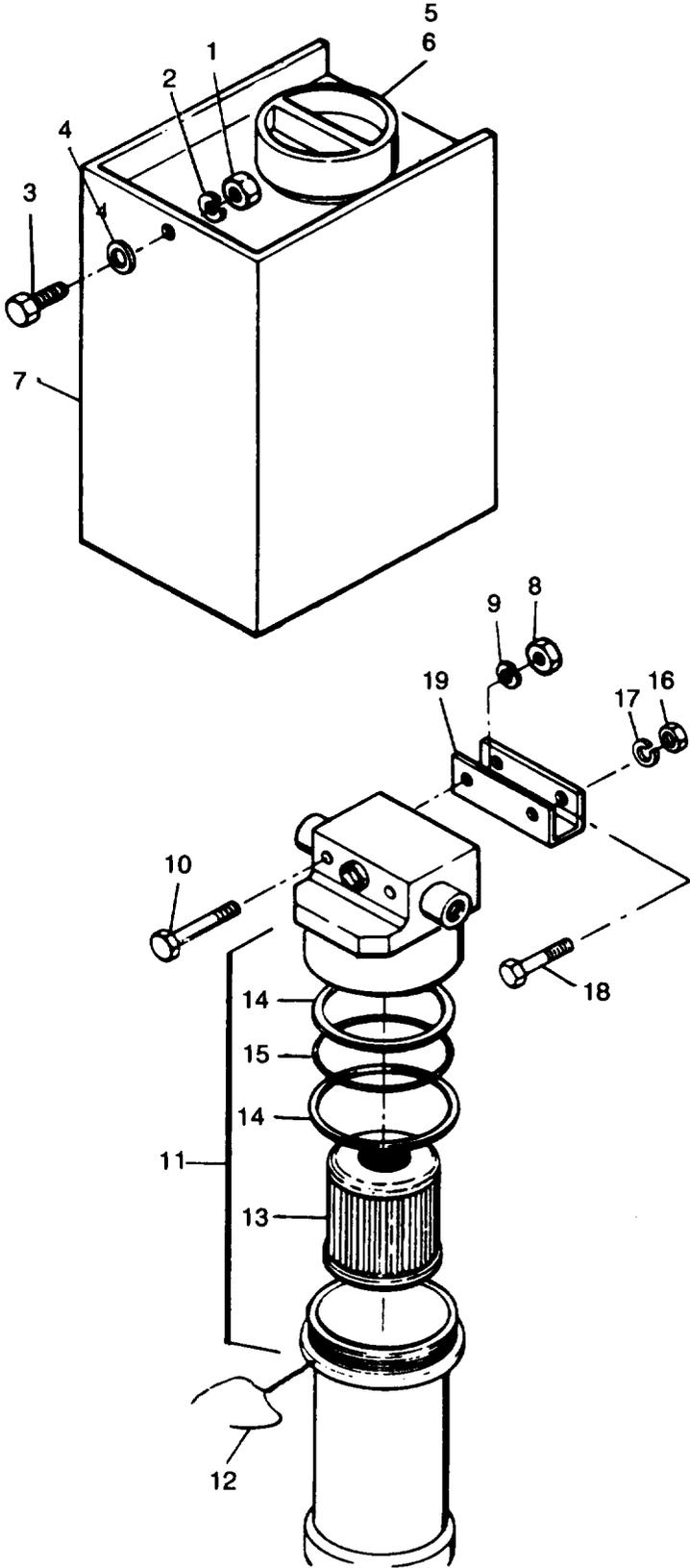

Figure 56. Hydraulic sump and filter.

(1) ILLUSTRATION		(2) SMR CODE				(3)		(4) NATIONAL STOCK NUMBER	(5) DESCRIPTION	(6) USABLE ON CODE	(7) QTY INC IN UNITS	(8) USMC QTY PER EQUIP
A FIG. NO.	B ITEM NO.	A ARMY	B AIR FORCE	C NAVY	D USMC	A SSI	B REPL FACTOR	REF NUMBER & MFR CODE	U/M			
56	1	PAFZZ	PAOZZ	PAOZZ	PAFZZ	D	.008	5310-00-880-7744 NUT, PLAIN, HEXAGON: OIL TANK MTG MS51967-5 96906	CLB,CLC, CZM,DGG	EA	2	
56	2	PAFZZ	PAOZZ	PAOZZ	PAFZZ	D	.010	5310-00-407-9566 WASHER, LOCK: OIL TANK MTG MS35338-45 96906	CLB,CLC, CZM,DGG			
56	3	PAFZZ	PAOZZ	PAOZZ	PAFZZ	D	.010	5306-00-225-8502 BOLT, MACHINE: OIL TANK MTG MS90725-38 96906	CLB,CLC, CZM,DGG	EA	2	
56	4	PAFZZ	PAOZZ	PAGZZ	PAGZZ	D	.010	5310-00-081-4219 WASHER, FLAT: OIL TANK MTG MS27183-12 96906	CLB,CLC CZM,DGG	EA	2	
56	5	PAOZZ	PAOZZ	XBOZZ	PAOZZ	D	.010	6680-00-606-5022 GAGE, ROD CAP 72-2132 30554 30554-72-2132 36024	CLB,CLC CZM,DGG	EA	1	
56	6	PAOZZ	PAOZZ		PAOZZ	-	.030	5330-01-101-4858 GASKET 72-2143 30554	CLB,CLC CZM,DGG	EA	1	
56	7	XBFZZ	PAOZZ	XBGZZ	PAFZZ	-	-	6115-00-611-8092 TANK, OIL 72-2033 30554 30554-72-2033 36024	CLB,CLC CZM,DGG	EA	1	
56	8	PAFZZ	PAOZZ	PAGZZ	PAFZZ	D	.008	5310-00-761-6882 NUT, PLAIN, HEXAGON: FILTER TO BRACKET MS51967-2 96906	CLB,CLC CZM,DGG	EA	2	
56	9	PAFZZ	PAOZZ	PAOZZ	PAFZZ	D	.010	5310-00-582-5965 WASHER, LOCK: FILTER TO BRACKET MS35338-44 96906	CLB,CLC CZM,DGG	EA	2	
56	10	PAFZZ	PAOZZ	PAGZZ	PAFZZ	D	.008	5305-00-071-2236 SCREW, CAP, HEXAGON HEAD: FILTER TO BRACKET MS90725-15 96906	CLB,CLC CZM,DGG	EA	2	
56	11	PAOZZ	PAOZZ	PAGGG	PAOZZ	-	.005	1650-00-288-6908 FILTER, HYDRAULIC: OIL MS28720-6 96906	CLB,CLC CZM,DGG	EA	1	
56	12	PAOZZ	PAOZZ	PAOZZ	PAOZZ	D	.003	9505-00-221-2650 WIRE, LOCK MS20995C20 96906	CLB,CLC CZM,DGG	FT	V	
56	13	PAOZZ	PAOZZ	PAOZZ	PAOZZ	-	1.000	4330-00-542-2060 ELEMENT, FILTER AN6235-2A 88044	CLB,CLC CZM,DGG	EA	1	
56	14	PAOZZ	PAOZZ	PAOZZ	PAOZZ	-	1.00	5330-00-491-9391 RING, BACKUP AN6246-27 88044	CLB,CLC CZM,DGG	EA	2	
56	15	PAOZZ	PAOZZ	PAOZZ	PAOZZ	-	1.000	5330-00-171-6649 PACKING, PREFORMED MS28775-223 96906	CLB,CLC CZM,DGG	EA	1	
56	16	PAFZZ	PAOZZ	PAGZZ	PAFZZ	D	.008	5310-00-761-6882 NUT, PLAIN, HEXAGON: BRACKET MTG MS51967-2 96906	CLB,CLC CZM,DGG	EA	2	
56	17	PAFZZ	PAOZZ	PAGZZ	PAFZZ	D	.010	5310-00-582-5965 WASHER, LOCK: BRACKET MTG MS35338-44 96906	CLB,CLC CZM,DGG	EA	2	
56	18	PAFZZ	PAOZZ	PAGZZ	PAFZZ	D	.008	5305-00-068-0502 SCREW, CAP, HEXAGON HEAD: BRACKET MTG MS90725-6 96906	CLB,CLC CZM,DGG	EA	2	
56	19	XBFZZ	MFO	XBGZZ	XBFZZ	-	-	BRACKET, MOUNTING: HYDRAULIC OIL FILTER MTG 72-2112 30554 30554-72-2112 36024	CLB,CLC CZM,DGG	EA	1	

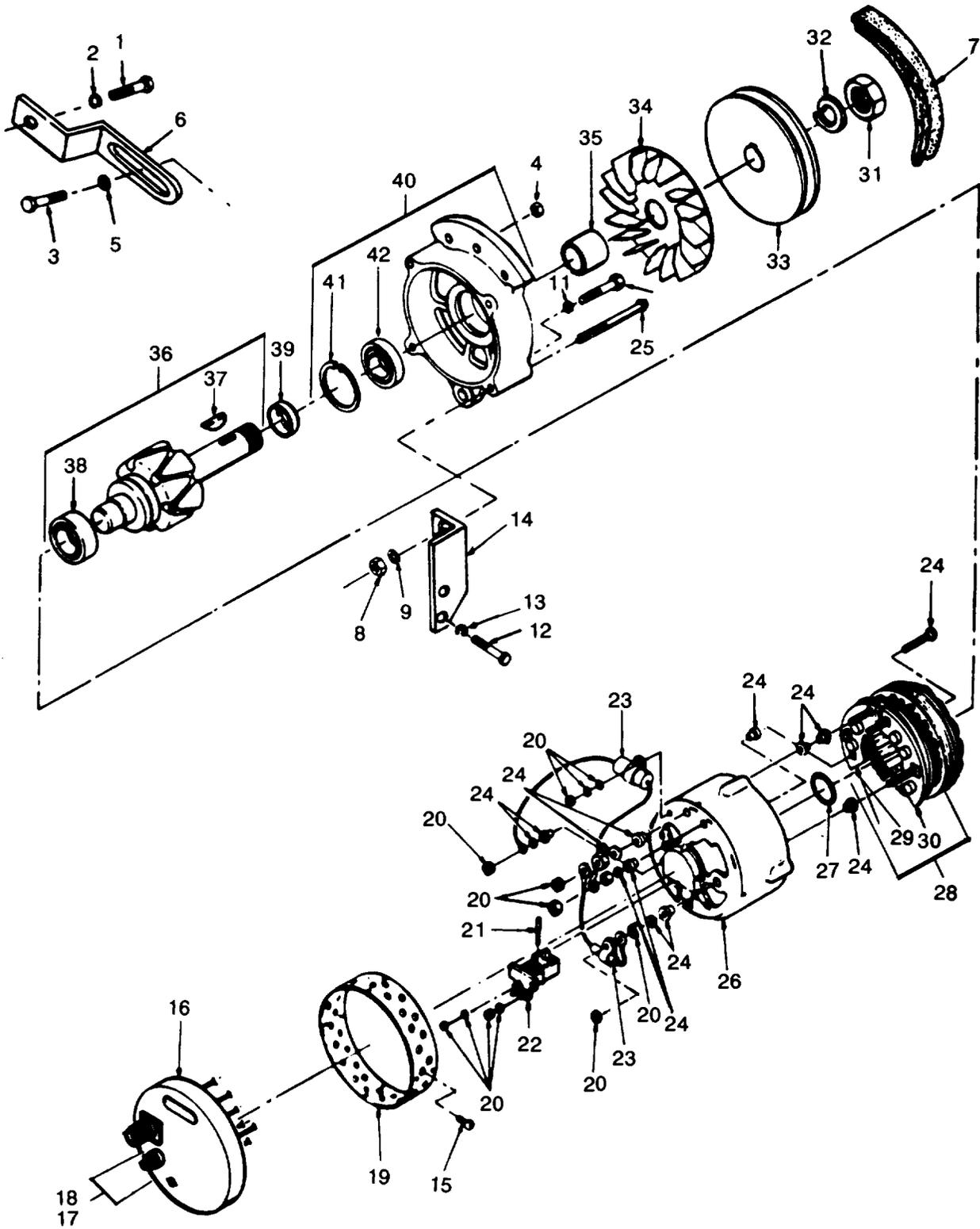

Figure 57. Battery charging alternator,

**TM 9-6115-465-24P
TO 35C2-3-446-4
NAVFAC P-8-625-24P
SL-4-06858B/06859D**

(1) ILLUS- TRATION		(2) SMR CODE				(3)		(4)	(5) DESCRIPTION		(6)	(7)	(8)
a	b	a	b	c	d	a	b	NATIONAL STOCK NUMBER	REF NUMBER & MFR CODE	USABLE ON CODE	U/M	QTY INC IN UNIT	USMC QTY PER EQUIP
FIG NO.	ITEM NO.	ARMY	AIR FORCE	NAVY	USMC	SSI	REPL FACTOR						
57	1	PAOZZ	PAOZZ	PAGZZ	PAFZZ	D	.008	53050-225-081	GROUP 20 - ENGINE ASSEMBLY SCREW, CAP HEXAGON HEAD: BRACKET TO BLOCK MS90725-36 96906	EA	1		
57	2	PAOZZ	PAOZZ	PAGZZ	PAFZZ	D	.010	5310-00-407-9566	WASHER, LOCK: BRACKET TO BLOCK MS35338-45 96906	EA	1		
57	3	PAOZZ	PAOZZ	PAOZZ	PAFZZ	D	.010	5305-00-225-9081	BOLT MACHINE BRACKET TO ALTERNATOR MS90725-36 96906	EA	1	44	
57	4	PAOZZ	PAOZZ	PAOZZ	PAFZZ	D	.010	5310-00-984-3806	NUT, SELF-LOCKING HEXAGON BRACKET TOEA ALTERNATOR MS51922-9 96906	1	41		
57	5	PAOZZ	PAOZZ	PAOZZ	PAFZZ	D	.010	5310-00-081-4219	WASHER, FLAT BRACKET TO ALTERNATOR MS27183-12 96906	EA	1	30	
57	6	PAOZZ	XB	XBGZZ	XBFZZ	-	-		BRACKET, ADJUSTING BELT TENSION 72-2021 30554 30554-72-2021 36024	EA	1	1	
57	7	PAOZZ	PAOZZ	PAOZZ	PAOZZ	-	-	3030-00-756-8416	BELT, FAN MS51066-59 96906	EA	1		
57	8	PAOZZ	PAOZZ	PAOZZ	PAFZZ	-	-	5310-00-768-0318	NUT, PLAIN, HEXAGON: ALTERNATOR MTG MS51967-14 96906	EA	1		
57	9	PAOZZ	PAOZZ	PAOZZ	PAFZZ	-	-	5310-00-584-5272	WASHER, LOCK: ALTERNATOR MTG MS35338-48 96906	EA	1		
57	10	PAOZZ	PAOZZ	PAOZZ	PAFZZ	-	-	5305-00-716-8128	SCREW, CAP, HEXAGON HEAD: ALTERNATOR MTG MS90725-117 96906	EA	1		
57	11	PAOZZ	PAOZZ	PAOZZ	PAFZZ	-	-	5310-00-809-5997	WASHER, FLAT: ALTERNATOR MTG MS27183-7 96906	EA	1		
57	12	PAFZZ	PAOZZ	PAGZZ	PAFZZ	D	.008	5305-00-716-8128	SCREW, CAP HEXAGON HEAD: BRACKET TO BLOCK MS90725-117 96906	EA	2		
57	13	PAFZZ	PAOZZ	PAGZZ	PAFZZ	D	.010	5310-00-584-5272	WASHER, LOCK MS35338-48 96906	EA	2		
57	14	XBFZZ	XB	XBFZZ	XBFZZ	-	-		BRACKET, ALTERNATOR 72-2004 30554 30554-72-2004 36024	EA	1		
57		PAOFF	PAOFF	PAHOH	PAFHH	-	.815	2920-01-013-5802	ALTERNATOR: BATTERY CHARGING 72-2250-2 30554 ANJ001 68505	EA	1		
57	15	PAFZZ	PAOZZ	PAHZZ	PAHZZ	-	-	5305-00-026-2577	SCREW, TAPPING: COVER ASSEMBLY MTG 20-121 31211	EA	8		
57	16	PAFZZ	PAOZZ	PAHZZ	PAHZZ	-	.008	2920-01-011-6439	REGULATOR, VOLTAGE ANJ1034S 19728	EA	1	1	
57	17	PAOZZ	PAOZZ		PAOZZ		1.00	5920-00-280-3478	FUSE CARTRIDGE AGS40 71400	EA	1		
57	18	PAOZZ	PAOZZ		PAOZZ	D	.008	5920-00-450-8921	FUSE, HOLDER FHN26G1 81349	EA	1		
57	19	XBFZZ	XB	PAHZZ	XBHZZ	-			BAND, COVER ANJ33 19728	EA	1		

(1) ILLUSTRATION		(2) SMR CODE				(3)		(4)	(5)	(6)	(7)	(8)
A	B	A	B	C	D	A	B	NATIONAL STOCK NUMBER	DESCRIPTION	USABLE ON CODE	QTY INC IN UNITS	USMC QTY PER EQUIP
FIG. NO.	ITEM NO.	ARMY	AIR FORCE	NAVY	USMC	SSI	REPL FACTOR		REF NUMBER & MFR CODE	U/M		
57	20	PAFZZ	PAOZZ	PAGZZ	PAHZZ	D	.008	5310-01-018-1314	NUT AND WASHER 90-33 19728	EA	1	
57	21	PAFZZ	PAOZZ	PAOZZ	PAHZZ	-	.470	5977-01-011-1154	BRUSH ASSEMBLY ALE1013AS 19728	EA	2	2
57	22	XBFZZ	PAOZZ	PAGZZ	PAHZZ	-	.030		BRUSH HOLDER ASSEMBLY ALU1045DS 19728	EA	1	1
57	23	PAFZZ	PAOZZ	PAGZZ	PAHZZ	-	.040	2920-01-029-6722	CAPACITOR AND CLAMP PACKAGE 90-2378 19728	EA	1	1
57	24	PAFZZ	PAOZZ	PAHZZ	PAHZZ	D	.005	2920-01-011-9357	TERMINAL STUD AND PARTS PACKAGE 90-2379 19728	EA	1	1
57	25	XBFZZ	PAOZZ	PAHZZ	XBHZZ	-	-		BOLT, THRU: HOUSING ALA20S 19728	EA	4	4
57	26	XBFZZ	XB	XBHZZ	XBHZZ	-	-		HEAD ASSEMBLY ANJ1002S 19728	EA	1	1
57	27	PAFZZ	PAOZZ	XBHZZ	PAHZZ	-	.030	5330-00-001-6680	PACKING, PREFORMED XA744AN 19728	EA	1	1
57	28	PAFFZ	PAOZZ	PAHZZ	PAHZZ	-	.050	2929-01-011-6467	RECTIFIER AND STATOR ASSEMBLY ANJ3008 19728	EA	1	1
57	29	PAFZZ	PAOZZ	PAHZZ	PAHZZ	-	.020	5961-01-020-2904	PLATE AND RECTIFIER ASSEMBLY ANJ1004S 19728	EA	1	1
57	30	PAFZZ	PAOZZ	PAHZZ	PAHZZ	-	.020	5961-01-020-4439	PLATE AND RECTIFIER ASSEMBLY ANJ1004AS 19728	EA	1	1
57	31	PAFZZ	PAOZZ	PAGZZ	PAHZZ	D	.008	5310-00-132-1526	NUT, FLAIN, HEXAGON: PULLEY MTG 20-4 31211	EA	1	1
57	32	PAFZZ	PAOZZ	PAGZZ	PAHZZ	D	.010	5310-00-436-1975	WASHER, LOCK: PULLEY MTG 20-5 31211	EA	1	1
57	33	PAFZZ	PAOZZ	PAGZZ	PAHZZ	D	.005	3020-01-026-1260	PULLEY, BELT PU702 19728	EA	1	1
57	34	XBFZZ	XB	PAHZZ	PAHZZ	-	-	2920-01-024-9414	FAN, ALTERNATOR PU1664 19728	EA	1	1
57	35	XBFZZ	XB	XBGZZ	XBHZZ	-	-		SPACER, FAN ALC21E 19728	EA	1	1
57	36	PAFZZ	PAOZZ	PAOZZ	PAHZZ	-	.030	2920-01-014-4070	ROTOR ASSEMBLY, ALTERNATOR ANJ2046 19728	EA	1	1
57	37	PAFZZ	PAOZZ	PAGZZ	PAHZZ	D	.020	5315-00-133-3625	KEY, WOODRUFF PULLEY 20-7 31211	EA	1	1
57	38	PAFZZ	PAOZZ	PAHZZ	PAHZZ	-	.023	3110-01-017-5579	BEARING REAR HOUSING X3433 19728	EA	1	1
57	39	PAFZZ	XB	XBHZZ	PAHZZ	D	.020	5310-00-565-9739	RETAINER FELT GR32 19728	EA	1	1
57	40	PAFZZ	PAOZZ	PAGZZ	XBHZZ	-			HEAD ASSEMBLY, ALTERNATOR ANJ1003 19728	EA	1	1
57	41	PAFZZ	XB	XBHZZ	PAHZZ	D	.015		RETAINER, BEARING N5001-156 19728	EA	1	1
57	42	PAFZZ	PAOZZ	PAHZZ	PAHZZ	-		3110-00-244-2865	BEARING FRONT HOUSING X3416 19728	EA	1	1

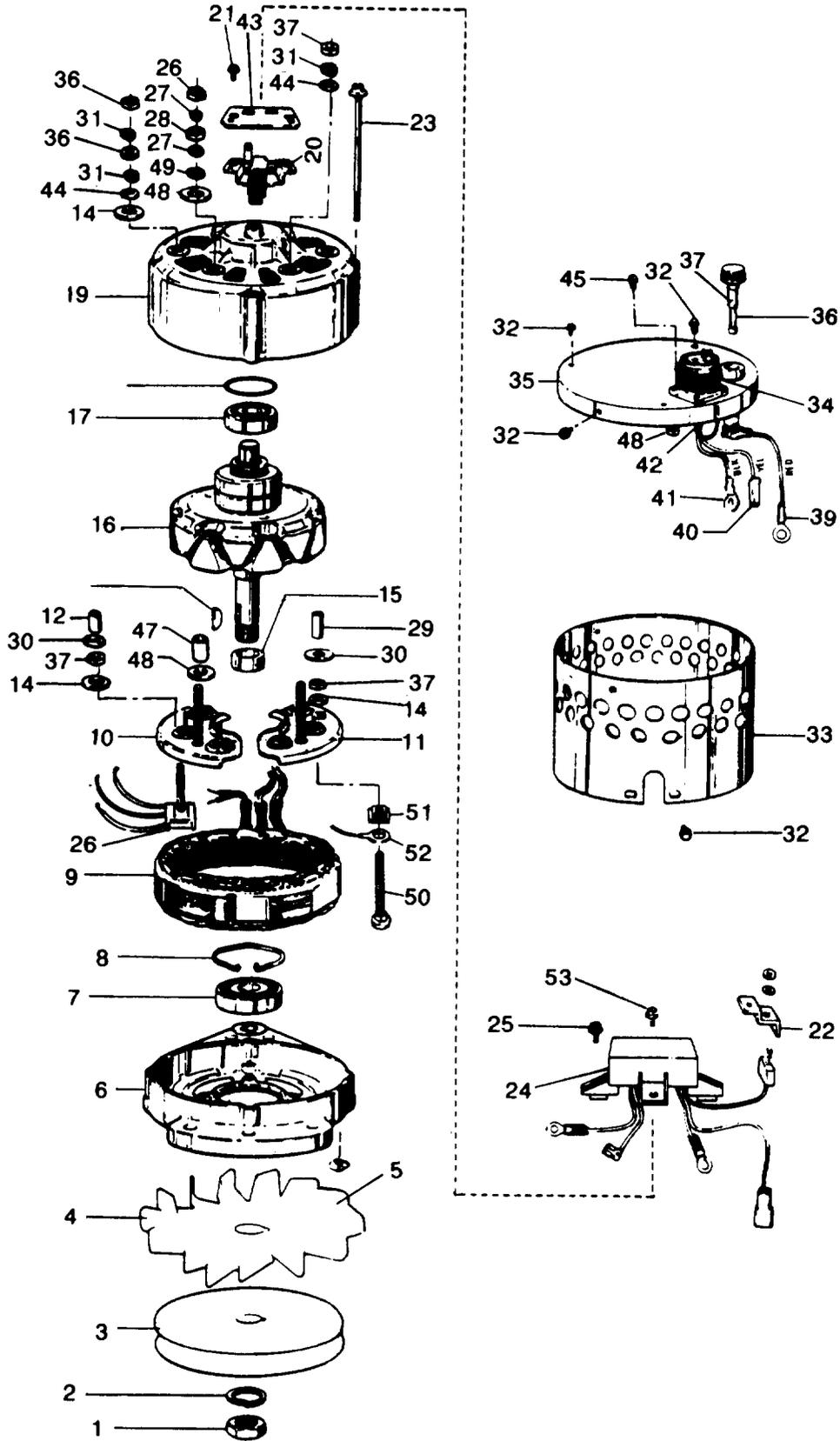

Figure 58. Alternator, Battery Charging. (Landscape)

(1) ILLUSTRATION		(2) SMR CODE				(3)		(4) NATIONAL STOCK NUMBER	(5) DESCRIPTION	(6) USABLE ON CODE	(7) QTY INC IN UNITS	(8) USMC QTY PER EQUIP
A FIG. NO.	B ITEM NO.	A ARMY	B AIR FORCE	C NAVY	D USMC	A SSI	B REPL FACTOR	REF NUMBER & MFR CODE	U/M			
58		PAOFF	PAOFF	PAHOH	PAFHH			2920-01-208-0805 ALTERNATOR, BATTERY, CHARGING INTRCH W P/N 72-2250-2 70D43103S01 31211	EA	1		
58	1	PAFZZ	PAOZZ	PAGZZ	PAHZZ			5310-00-343-1451 NUT, PULLEY MOUNTING 20-136 31211	EA	1		
58	2	PAFZZ	PAOZZ	PAGZZ	PAHZZ			5310-00-245-8670 WASHER,SPLIT LOCK 5/8" 20-137 31211	EA	1		
58	3	PAFZZ	PAOZZ	PAGZZ	PAHZZ			3020-00-207-9284 PULLEY 7-75 31211	EA	1		
58	4	PAFZZ	XB	PAHZZ	XBHZZ			FAN 7-8 31211	EA	1		
58	5	PAOZZ	PAOZZ	PAOZZ	PAFZZ			NUT SQUARE 20-150 31211	EA	1		
58	6	PAFZZ	PAOZZ	PAGZZ	XBHZZ			HOUSING, FRONT 14-46 31211	EA	1		
58	7	PAFZZ	PAOZZ	PAHZZ	PAHZZ			3110-00-123-2583 BEARING, FRONT 11-42 31211	EA	1		
58	8	PAFZZ	XB	XBHZZ	PAHZZ			5365-00-133-0909 RETAINER, FRONT BEARING 11-3 31211	EA	1		
58	9	PAFZZ	PAOZZ	PAHZZ	PAHZZ			6105-00-105-8290 STATOR ASSEMBLY 13-5 31211	EA	1		
58	10	PAFZZ	PAOZZ	PAHZZ	PAHZZ			DIODE ASSEMBLY, RECTIFIER POSITIVE 1-171 31211	EA	1		
58	11	PAFZZ	PAOZZ	PAHZZ	PAHZZ			DIODE ASSEMBLY, RECTIFIER NEGATIVE 1-126 31211	EA	1		
58	12	PAFZZ	PAOZZ	PAHZZ	PAHZZ			SLEEVE, INSULATING, NO. 10 STUD, .30" LONG 15-27 31211	EA	1		
58	13	PAFZZ	PAOZZ	PAGZZ	PAHZZ			5315-00-133-3625 KEY,WOODRUFF 20-7 31211	EA	1		
58	14	PAFZZ	PAOZZ	PAGZZ	PAHZZ			5970-00-148-6300 WASHER, INSULATING NO. 10 STUD. 3/4" O.D 15-3 31211	EA	3		
58	15	PAFZZ	XB	XBGZZ	PAHZZ			5365-01-012-3600 SPACER,FAN 20-92 31211	EA	1		
58	16	PAFZZ	PAOZZ	PAOZZ	PAHZZ			2920-00-133-9888 ROTOR ASSEMBLY 12-25 31211	EA	1		
58	17	PAFZZ	PAOZZ	PAGZZ	PAHZZ			3110-00-130-7718 BEARING, REAR 11-41 31211	EA	1		
58	18	PAFZZ	XB	XBHZZ	PAHZZ			5330-01-100-2073 RETAINER,REAR BEARING 11-25 31211	EA	1		
58	19	PAFZZ	PAOZZ	PAGZZ	XBHZZ			HOUSING, REAR 14-207 31211	EA	1		
58	20	PAFZZ	PAOZZ	PAOZZ	PAHZZ			BRUSH ASSEMBLY 3-15 31211	EA	1		
58	21	PAFZZ	PAOZZ	PAHZZ	PAHZZ			SCREW, TAPPING, NO. 8 1/2" 20-102 31211	EA	1		

(1) ILLUSTRATION		(2) SMR CODE				(3)		(4) NATIONAL STOCK NUMBER		(5) DESCRIPTION	(6) USABLE ON CODE	(7) QTY INC IN UNITS	(8) USMC QTY PER EQUIP
A FIG. NO.	B ITEM NO.	A ARMY	B AIR FORCE	C NAVY	D USMC	A SSI	B REPL FACTOR		REF NUMBER & MFR CODE	U/M			
58	22	PAFZZ	PAOZZ	PAGZZ	PAHZZ				BRACKET, RHEOSTAT ASSEMBLY 16-126 31211	EA	1		
58	23	PAFZZ	PAOZZ	PAHZZ	XBHZZ				BOLT, THROUGH 20-143 31211	EA	4		
58	24	PAFZZ	PAOZZ	PAHZZ	PAHZZ			6110-01-226-4681	VOLTAGE REGULATOR 5-255 31211	EA	1		
58	25	PAFZZ	PAOZZ	PAHZZ	PAHZZ				SCREW, TAPPING, REGULATOR MOUNTING 20-223 31211	EA	1		
58	26	PAFZZ	PAOZZ	PAHZZ	PAHZZ				DIODE ASSEMBLY, FIELD 1-130 31211	EA	1		
58	27	PAFZZ	PAOZZ	PAGZZ	PAHZZ				WASHER, SPLITLOCK 1/4" 20-113 31211	EA	2		
58	28	PAFZZ	PAOZZ	PAOZZ	PAFZZ				NUT, HEX 1/4"-20 20-160 31211	EA	2		
58	29	PAFZZ	PAOZZ	PAHZZ	PAHZZ				SLEEVE, INSULATING, NO. 10 STUD, .38" LONG 15-39 31211	EA	1		
58	30	PAFZZ	PAOZZ	PAGZZ	PAHZZ				WASHER, INSULATING NO. 10 STUD. 5/8" O.D. 15-51 31211	EA	2		
58	31	PAFZZ	PAOZZ	PAGZZ	PAHZZ			5310-00-168-6374	WASHER, SPLITLOCK, NO. 10 20-111 31211	EA	3		
58	32	PAFZZ	PAOZZ	PAHZZ	PAHZZ			5305-00-026-2577	SCREW, TAPPING, 8-32 X5/16" LONG 20-121 31211	EA	13		
58	33	XBFFZZ	XB	PAHZZ	XBHZZ				HOUSING AND SHIELDS ASSEMBLY 14-209 31211	EA	1		
58	34	PAFPZ	PAOZZ	PAOZZ	PAOZZ				CONNECTOR PLUG ASSEMBLY 16-125 31211	EA	1		
58	35	XBFFZZ	XB	XBFFZZ	XBFFZZ				COVER 14-208 31211	EA	1		
58	36	PAFZZ	PAOZZ	PAOZZ	PAFZZ			5310-00-020-4737	NUT, HEX 10-24 20-34 31211	EA	5		
58	37	PAOZZ	PAOZZ	PAOZZ	PAOZZ				FUSE 40 AMP 2-9 31211	EA	1		
58	38	PAOZZ	PAOZZ	PAOZZ	PAOZZ			5920-00-450-8921	RECEPTACLE AND FUSE COMPLETE 2-8 31211	EA	1		
58	39	PAFZZ	PAOZZ	PAOZZ	PAOZZ				CONNECTOR LEAD, RED, 1/4" RING TERMINAL 16-80 31211	EA	1		
58	40	PAFZZ	PAOZZ	PAOZZ	PAOZZ				CONNECTOR LEAD, YELLOW, SPADE TML 16-82 31211	EA	1		
58	41	PAFZZ	PAOZZ	PAOZZ	PAOZZ				CONNECTOR, LEAD, BLACK NO. 10 RING TML 16-81 31211	EA	1		
58	42	PAFZZ	PAOZZ	PAOZZ	PAOZZ				CONNECTOR LEAD, FUSE HOLDER 16-93 31211	EA	1		
58	43	PAFZZ	PAOZZ	PAHZZ	PAHZZ				COVER, BRUSH ASSEMBLY 3-5 31211	EA	1		
58	44	PAFZZ	PAOZZ	PAOZZ	PAFZZ			5310-00-824-2688	WASHER, FLAT NO. 10 STUD 20-120 31211	EA	2		

TM9-6115-465-24P
 TO35CZ-3-446-4
 NAVFACP-8-625-24P
 SL-4-06858B/06859D

(1) ILLUSTRATION		(2) SMR CODE				(3)		(4) NATIONAL STOCK NUMBER	(5) DESCRIPTION	(6) USABLE ON CODE	(7) QTY INC IN UNITS	(8) USMC QTY PER EQUIP
A FIG. NO.	B ITEM NO.	A ARMY	B AIR FORCE	C NAVY	D USMC	A SSI	B REPL FACTOR	REF NUMBER & MFR CODE	U/M			
58	45	PAFZZ	PAOZZ	PAGZZ	PAFZZ			SCREW, 4-40 X 1/4" 20-156 31211	EA	4		
58	46	PAFZZ	PAOZZ	PAOZZ	PAFZZ			LOCKNUT, 4-40 20-320 31211	EA	4		
58	47	PAFZZ	PAOZZ	PAHZZ	PAHZZ			SLEEVE, INSULATOR 1/4" STUD 15-26 31211	EA	2		
58	48	PAFZZ	PAOZZ	PAGZZ	PAHZZ			WASHER, INSULATOR 1/4" STUD 16-27 31211	EA	2		
58	49	PAFZZ	PAOZZ	PAOZZ	PAFZZ			WASHER, FLAT 1/4" STUD 20-109 31211	EA	1		
58	50	PAFZZ	PAOZZ	PAHZZ	PAHZZ			BOLT, CARRIAGE NO. 10-24 X 3/8" 20-93 31211	EA	1		
58	51	PAFZZ	PAOZZ	PAHZZ	PAHZZ		2920-00-133-3295	INSULATOR, SQUARE MOLDED 15-7 31211	EA	1		
58	52	PAFZZ	PAOZZ	PAOZZ	PAOZZ			CABLE, AC TAP 16-98 31211	EA	1		
58	53	PAFZZ	PAOZZ	PAOZZ	PAOZZ			SCREW, TAPPING, REGULATOR MOUNTING 20-234 31211	EA	2		

(1) ILLUSTRATION		(2) SMR CODE				(3)			(4) NATIONAL STOCK NUMBER	(5) DESCRIPTION	(6) USABLE ON CODE	(7) QTY INC IN UNITS	(8) USMC QTY PER EQUIP
A FIG. NO.	B ITEM NO.	A ARMY	B AIR FORCE	C NAVY	D USMC	A SSI	B REPL FACTOR		REF NUMBER & MFR CODE	U/M			
59	1	PAFZZ	PAOZZ	XBGZZ	PAFZZ	D	.003	9505-00-221-2650	WIRE, LOCK MS2095C20 96906	CLB,CLC, CZM,DGG	FT	2	
59	2	PAFZZ	PAOZZ	XBGZZ	PAFZZ	D	.008	5306-00-618-0717	SCREW, CAP. HEXAGON HEAD: HYDRAULIC PUMP MTG 4039A 28265	CLB,CLC, CZM,DGG	EA	4	4
59	3	PAFZZ	PAOZZ	PAGZZ	PAFZZ	D	.010	5310-00-193-9703	WASHER, FLAT: HYDRAULIC PUMP MTG PX1080 00320	CLB,CLC, CZM,DGG	EA	4	4
59	4	PAFZZ	PAOZZ	PAGZZ	PAFZZ	-	.040	5330-00-972-8836	GASKET: PUMP MTG 288705A 28265	CLB,CLC,	EA	1	1
59	5	PAFZZ	PAOZZ	PAGZZ	PAFZZ	D	.013	5315-00-842-3044	PIN, COTTER: GEAR MS9245-47 96906	CLB,CLC, CZM,DGG	EA	1	
59	6	PAFZZ	PAOZZ	PAGZZ	PAFZZ	D	.008	5310-00-994-1601	NUT, CASTELLATED: GEAR MTG MS35692-23 96906	CLB,CLC, CZM,DGG	EA	1	
59	7	PAFZZ	PAOZZ	PAGZZ	PAFZZ	-	.004	3020-00-615-8585	GEAR, PUMP DRIVE: 72-2219 30554 30554-72-2219 36024	CLB,CLC, CZM,DGG	EA	1	
59	8	XBFZZ	XC	XBGZZ	XBFZZ	-	-		SPACER, PUMP 72-2052 30554 30554-72-2052 36024	CLB,CLC, CAM,DGG	EA	1	
59		PAFFH	PAOZZ	PBGGG	PAFFH	-	.250	4320-00-607-7663	PUMP, HYDRAULIC 72-2218 30554 22YB917-2L03G 64294	CLB,CLC, CZM,DGG	EA	1	
59	9	XBFZZ	XB	XBGZZ	XBHZZ	-	-		KEY, WOODRUFF: DRIVE GEAR 29629-10 64292	CLB,CLC, CZM,DGG	EA	1	1
59	10	PAFZZ	PAOZZ	XBGZZ	PAHZZ	D	.008	5310-00-615-1830	NUT, JAM: PRESSURE SCREW 151-39536 64292	CLB,CLC, CZM,DGG	EA	1	
59	11	PAFZZ	PAOZZ	XBGZZ	PAHZZ	D	.006	5305-00-263-8374	SCREW, PRESSURE 151-41465 64294	CLB,CLC, CZM,DGG	EA	1	
59	12	PAFZZ	PAOZZ	XBGZZ	PAHZZ	D	.010	5310-00-595-6475	WASHER, FLAT: PRESSURE SCREW 29602-6 64294	CLB,CLC, CZM,DGG	EA	1	
59	13	PAFZZ	PAOZZ	PAGZZ	PAHZZ	D	.010	5330-00-932-1865	WASHER, SEALING 151-39538 64294	CLB,CLC, CZM,DGG	EA	1	
59	14	XBFZZ	XC	XBGZZ	XBHZZ	-	-		BLOCK 15-38029 64294	CLB,CLC, CZM,DGG	EA	1	
59	15	PAFZZ	PAOZZ	PAGZZ	PAHZZ	-	.030	5330-00-966-9138	PACKING, PREFORMED 29791-906 64294	CLB,CLC, CZM,DGG	EA	1	
59	16	XBFZZ	XC	XBGZZ	XBHZZ	-	-		PLUG 252-39534 64294	CLB,CLC, CZM,DGG	EA	1	
59	17	PAFZZ	PAOZZ	PAGZZ	PAHZZ	D	.010	5360-00-135-1105	SPRING, VALVE 151-37606-1 64294	CLB,CLC, CZM,DGG	EA	1	
59	18	XBFZZ	XC	XBGZZ	XBHZZ	-	-		EYELET 151-41464 64294	CLB,CLC, CZM,DGG	EA	1	
59	19	PAFZZ	PAOZZ	XBGZZ	PAHZZ	D	.008	5305-01-018-0122	SCREW, MACHINE: SEAL PLATE MTG 29569-23 64294	CLB,CLC, CZM,DGG	EA	1	
59	20	PAFZZ	PAOZZ	PAGZZ	PAHZZ	D	.013	2990-00-135-6416	PLATE, SEAL 151-36159 64294	CLB,CLC, CZM,DGG	EA	1	

(1) ILLUSTRATION		(2) SMR CODE				(3)		(4) NATIONAL STOCK NUMBER	(5) DESCRIPTION	(6) USABLE ON CODE	U/M	(7) QTY INC IN UNITS	(8) USMC QTY PER EQUIP
A FIG. NO.	B ITEM NO.	A ARMY	B AIR FORCE	C NAVY	D USMC	A SSI	B REPL FACTOR	REF NUMBER & MFR CODE	CLB,CLC, CZM,DGG				
59	21	PAFZZ	PAOZZ	PAGZZ	PAHZZ	D	.008	5305-00-007-6310 SCREW, CAP, HEXAGON HEAD: COVER MTG 29530-66 64294	CLB,CLC, CZM,DGG	EA	1		
59	22	XBFZZ	PAOZZ	XBGZZ	XBHZZ	-	-	PIN, DOWEL 151-36162 64294	CLB,CLC, CZM,DGG	EA	1		
59	23	XBFZZ	XA	XBGZZ	XBHZZ	-	-	COVER ASSEMBLY 150-36176 64294	CLB,CLC, CZM,DGG	EA	1		
59	24	PAFZZ	PAOZZ	PAGZZ	PAHZZ	-	.024	3110-00-902-1649 BEARING, NEEDLE 151-36154 64294	CLB,CLC, CZM,DGG	EA	1		
59	25	XBHZZ	PAOZZ	XAGZZ	XBHZZ	-	-	COVER, BODY 151-36175-1 64294	CLB,CLC, CZM,DGG	EA	1		
59	26	PAFZZ	PAOZZ	PAGZZ	PAHZZ	-	.030	5330-00-150-1653 PACKING, PREFORMED 29791-011 64294	CLB,CLC, CZM,DGG	EA	1		
59	27	PAFZZ	PAOZZ	XBGZZ	PAHZZ	-	.024	2990-00-135-6419 GEAR, IDLER 152-36172-6 64294	CLB,CLC, CZM,DGG	EA	1		
59	28	XBFZZ	XA	XBGZZ	PAHZZ	-	-	2990-00-135-6418 SHAFT, DRIVE 152-40008-1 64294	CLB,CLC, CZM,DGG	EA	1		
59	29	PAFZZ	PAOZZ	PAGZZ	PAHZZ	D	.013	2520-00-477-5996 PLATE, SEAL 151-36164-2 64294	CLB,CLC, CZM,DGG	EA	1		
59	30	PAFZZ	PAOZZ	PAGZZ	PAHZZ	-	.007	2990-00-135-6420 VALVE, CHECK 151-41463 64294	CLB,CLC, CZM,DGG	EA	1		
59	31	XBFZZ	XA	XAGZZ	XBHZZ	-	-	BODY ASSEMBLY 152-36156-18 64294	CLB,CLC, CZM,DGG	EA	1		
59	32	PAFZZ	PAOZZ	XBGZZ	PAHZZ	-	.023	4820-00-614-6468 SEAT, VALVE 151-36179 64294	CLB,CLC, CZM,DGG	EA	1		
59	33	PAFZZ	PAOZZ	PAGZZ	PAHZZ	-	.024	BEARING, NEEDLE 151-36154 64294	CLB,CLC, CZM,DGG	EA	1		
59	34	XBFZZ	XA	XAGZZ	XBHAA	-	-	BODY, PUMP 151-36155-7 64294	CLB,CLC, CZM,DGG	EA	1		

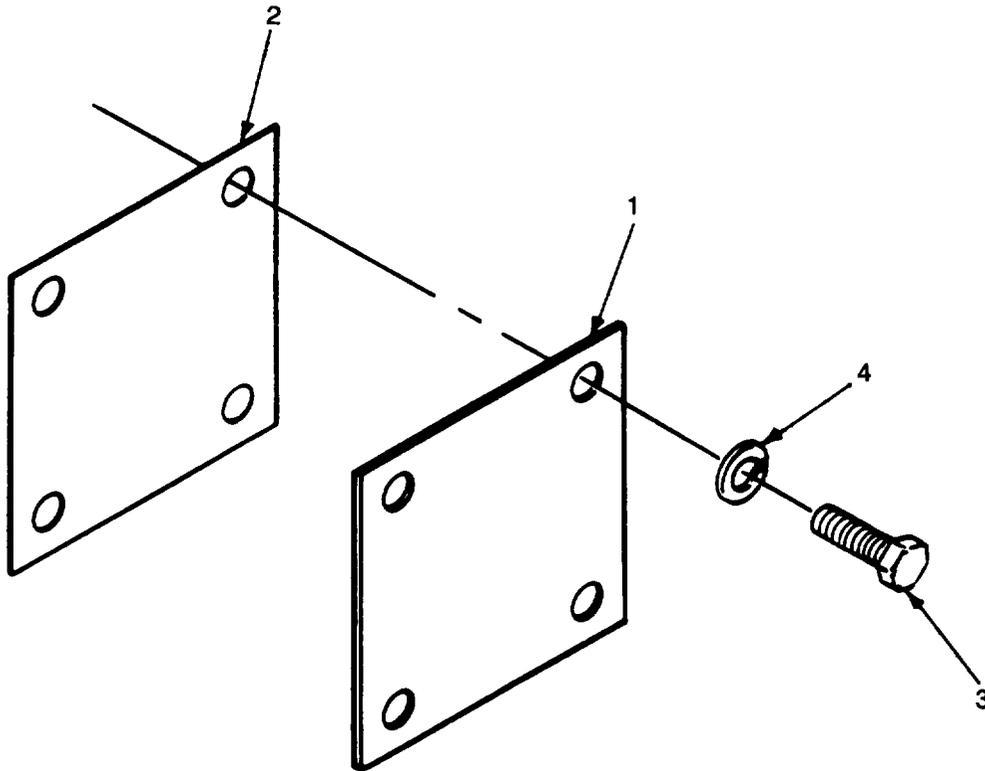

Figure 60 Plate Cover, Take Off, Hydraulic Pump.

TM9-6115-465-24P
 TO 35C2-3-446-4
 NAVFAC P-8-625-24P
 SL-4-06858B/06859D

(1) ILLUSTRATION		(2) SMR CODE				(3)		(4) NATIONAL STOCK NUMBER	(5) DESCRIPTION	USABLE ON CODE	(6) U/M	(7) QTY INC IN UNITS	(8) USMC QTY PER EQUIP
A FIG. NO.	B ITEM NO.	A ARMY	B AIR FORCE	C NAVY	D USMC	A SSI	B REPL FACTOR	REF NUMBER & MFR CODE					
60	1	XDFZZ			XBOZZ			PLATE COVER 83-2001 30554	CLC	EA	1		
60	2	PAFZZ			PAFZZ			GASKET 83-2002 30554 83-2002 30554	CLC	EA	1		
60	3	PAFZZ			PAFZZ			5306-00-225-8496 BOLT MACHINE M590725-31 96906	CLC	EA	4		
60	4	PAFZZ			PAFZZ			5310-00-639-6385 WASHER, FLAT PN151328 73370	CLC	EA	4		

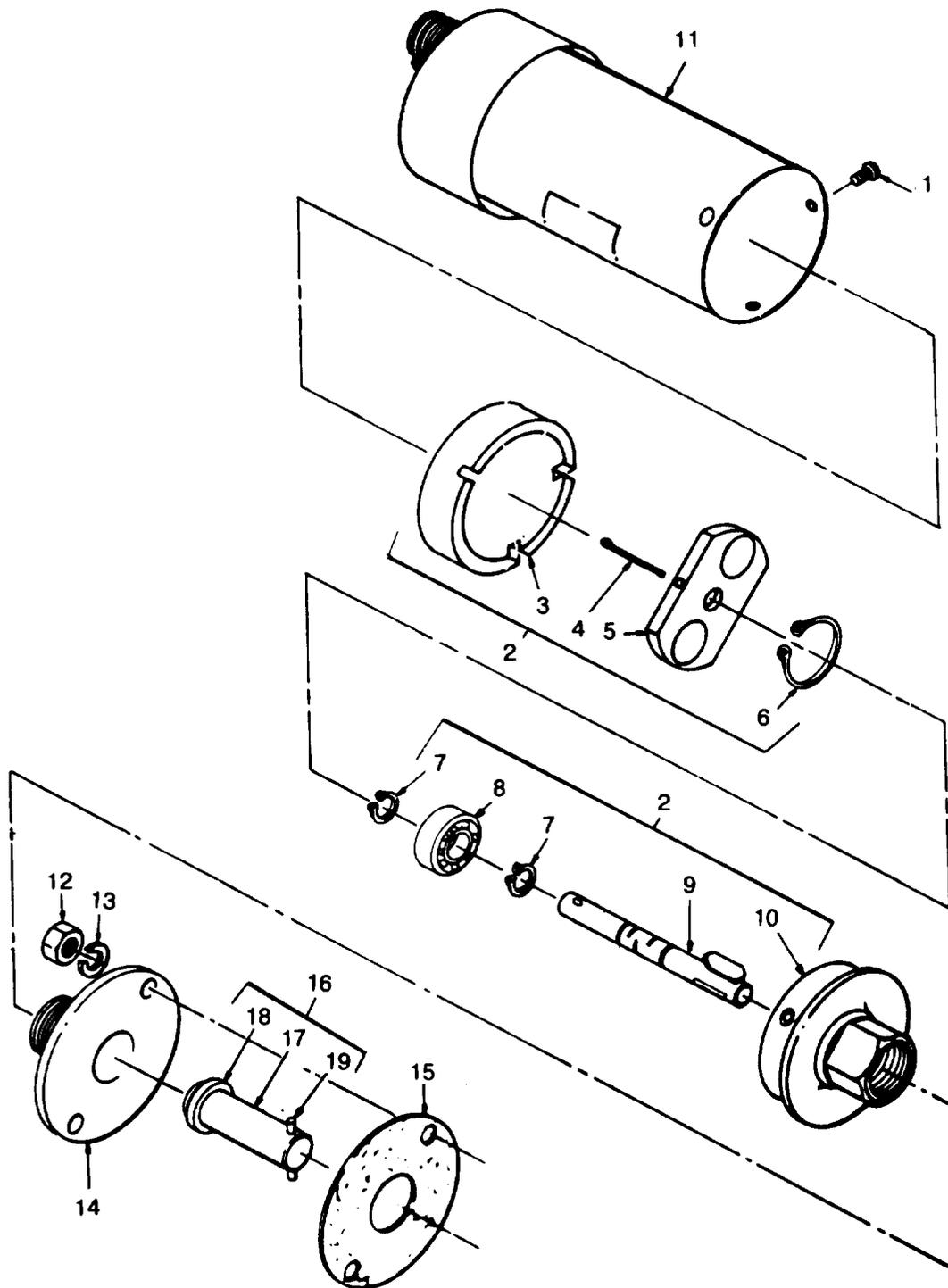

Figure 61. Speed switch.

(1) ILLUSTRATION		(2) SMR CODE				(3)		(4) NATIONAL STOCK NUMBER	(5) DESCRIPTION	(6) USABLE ON CODE	(7) QTY INC IN UNITS	(8) USMC QTY PER EQUIP
A FIG. NO.	B ITEM NO.	A ARMY	B AIR FORCE	C NAVY	D USMC	A SSI	B REPL FACTOR	REF NUMBER & MFR CODE	U/M			
61		PAOFF	PAOFF	PBGGG	PAFFF		.700	5930-01-246-9266 SWITCH, SPEED: ENGINE 70-1105-4 30554 72-2203-1 54125	CLA,CZN	EA	2 1	
61		PAOFF	PAOFF	PBGGG	PAFFF		.700	5930-01-018-1888 SWITCH, SPEED: ENGINE 70-1105-3 30554 72-2203-2 54125	CLC,DGG	EA	1	
61	1	PAFZZ	PAOZZ	PAGZZ	PAFZZ	D	.008	5305-00-059-7666 SCREW, MACHINE MS35206-15 96906		EA	3 3	
61	2	PAFZZ	PAOZZ	PAGZZ	PAFZZ	D	.008	5930-01-018-6787 BASE ASSEMBLY 8170619 54125		EA	1 1	
61	3	XAFZZ	XA	XBHZZ	XAFZZ			CAP, ROTOR 8170616 54125		EA	1 1	
61	4	XAFZZ	XA	XBHZZ	PAFZZ	D	.068	5315-00-017-9252 PIN, COTTER MS24665-136 96906		EA	1 1	
61	5	XAFZZ	XA	XBHZZ	XAFZZ			ROTOR 8170614 54125		EA	1 1	
61	6	XAFZZ	XA	XBHZZ	PAFZZ		.009	5365-01-017-3981 RING, RETAINING: BEARING 801-043 54125		EA	1 1	
61	7	XAFZZ	XA	XBHZZ	PAFZZ		.009	5365-01-017-0573 RING, RETAINING: SHAFT 801-042 54125		EA	2 2	
61	8	XAFZZ	XA	XBHZZ	PAFZZ		.050	3110-01-015-5398 BEARING, SHAFT 801-058 54125		EA	1 1	
61	9	XAFZZ	XA	XA---	XAFZZ			SHAFT 8170613 54125		EA	1 1	
61	10	XAFZZ	XA	XBHZZ	XAFZZ			BASE 817010 54125		EA	1 1	
61	11	PAFZZ	PAOZZ	PAHZZ	PAFZZ		.050	ELECTRONIC ASSEMBLY 8180100 54125		EA	1 1	
61	12	PAFZZ	PAOZZ	PAHZZ	PAFZZ	D	.008	5310-00-268-6093 NUT, PLAIN, HEXAGON: SWITCH MTG 28A 28265		EA	2 2	
61	13	PAFZZ	PAOZZ	PAHZZ	PAFZZ	D	.010	5310-00-010-3320 WASHER, LOCK: SWITCH MTG 615A 28265		EA	2 2	
61	14	PAFZZ	PAOZZ	PAHZZ	PAFZZ	D	.008	3040-01-050-1666 SPEED SWITCH ADAPTER 40-0003828 28265		EA	1 1	
61	15	PAFZZ	PAOZZ	PAHZZ	PAFZZ		.040	5330-00-842-0363 GASKET: COVER MTG (PART OF KIT, P/N 40-3094662A) 255772A 28265		EA	1 1	
61	16	PAFZZ	PAOZZ	PAHZZ	PAFZZ	D	.009	3040-01-025-0511 SHAFT, DRIVE 40-0018651A 28265		EA	1 1	
61	17	XAFZZ	XA	XBHZZ	XAFZZ			SHAFT 40-0018001A 28265		EA	1 1	
61	18	XAFZZ	XA	PAHZZ	XAFZZ			BUSHING, SHAFT 375045A 28265		EA	1 1	
61	19	XAFZZ	XA	PAHZZ	XAFZZ			PIN, ROLL 2175-12650 28265		EA	1 1	

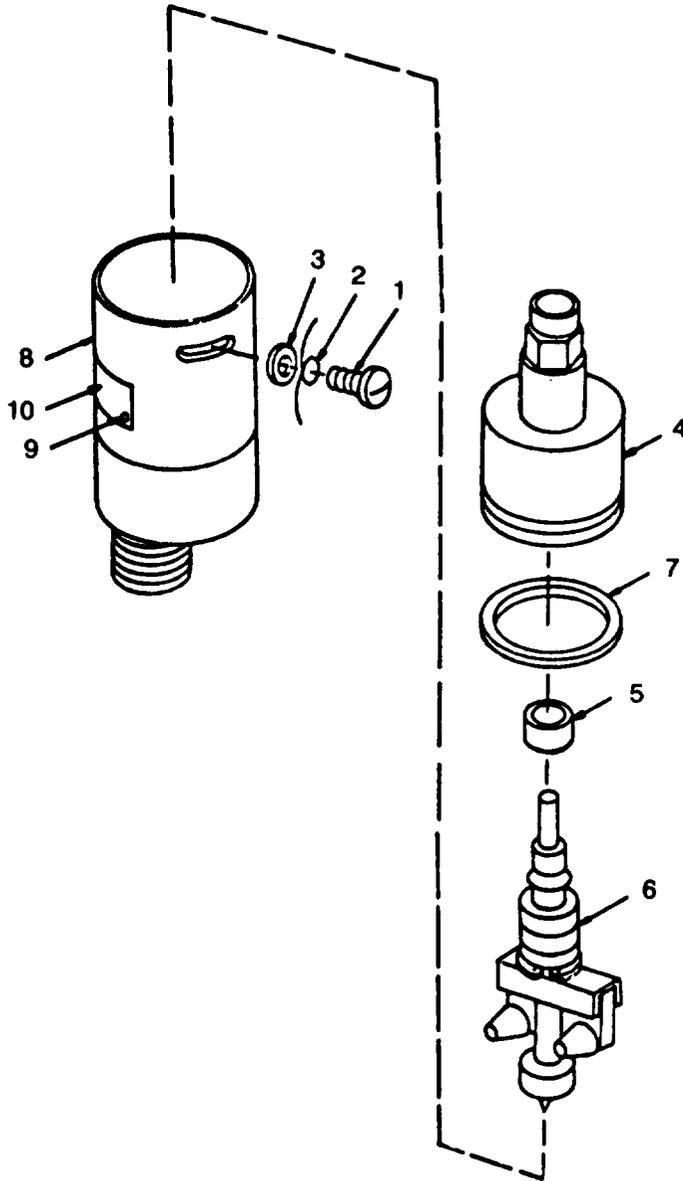

Figure 62. Speed switch

TM9-6115-465-24P
 TO 35C2-3-446-4
 NAVFAC P-8-625-24P
 SL-4-06858B/06859D

(1) ILLUSTRATION A	(2) SMR CODE A	B	C	D	(3)		(4) NATIONAL STOCK NUMBER	(5) DESCRIPTION REF NUMBER & MFR CODE	(6) USABLE ON CODE U/M	(7) QTY INC IN UNITS	(8) USMC QTY PER EQUIP		
					A	B							
FIG. NO.	ITEM NO.	ARMY	AIR FORCE	NAVY	USMC	SSI	B REPL FACTOR						
62		PAOFF	PAOFF		PAFFF		.700	5930-00-430-3540	SWITCH, CENTRIFUGAL 70-1105-2 30554 SA897-3DOB 78388	CLB,CZM	EA	1	1
62		PAOFF	PAOFF		PAFFF			5930-01-021-9378	SPEED SWITCH, ENGINE 70-1105-1 30554 SA1644-3DOB 78388	DGG,CLC	EA	1	1
62	1	PAFZZ	PAOZZ		PAFZZ	D	.008		SCREW, CAP, HEXAGON SE156-5A1 78388	CLB,CLC DGG,CZM	EA	3	3
62	2	XBFZZ	XB		XBFZZ		.008		LOCKWIRE ST89 78388	CLB,CLC DGG,CZM	EA	1	1
62	3	PAFZZ	PAOZZ		PAFZZ	D	.010	5310-00-515-8058	WASHER, FLAT AN960-8 88044	CLB,CLC DGG,CZM	EA	3	11
62	4	XAFZZ	XA		XAFZZ				BODY ASSY SB900 78388	CLB,CLC DGG,CZM	EA	1	1
62	5	XAFZZ	XA		XAFZZ				SPACER SE402 78388	CLB,CLC DGG,CZM	EA	1	1
62	6	XAFZZ	XA		XAFZZ				ROTOR ASSY SB776E 78388	CLB,CLC DGG,CZM	EA	1	1
62	7	PAFZZ	PAOZZ		PAFZZ		.060	5330-00-194-3713	PACKING PREFORMED SE234 78388	CLB,CLC DGG,CZM	EA	1	1
62	8	PAFZZ	PAOZZ		PAFZZ		.060		CAP AND COVER ASSY SB1014E 78388	CLB,CZM	EA	1	1
62	8	PAFZZ	PAOZZ		PAFZZ		.060	6115-01-075-6616	CAP AND COVER ASSEMBLY SB1013A 78388	CLC,DGG	EA	1	1
62	9	PAFZZ	PAOZZ		PAFZZ	D	.008		SCREW, MACHINE SE117A 78388	CLB,CLC DGG,CZM	EA	2	1
62	10	XCFZZ	XC		MDOZZ				PLATE, IDENTIFICATION SE122 78388	CLB,CLC DGG,CZM	EA	1	1

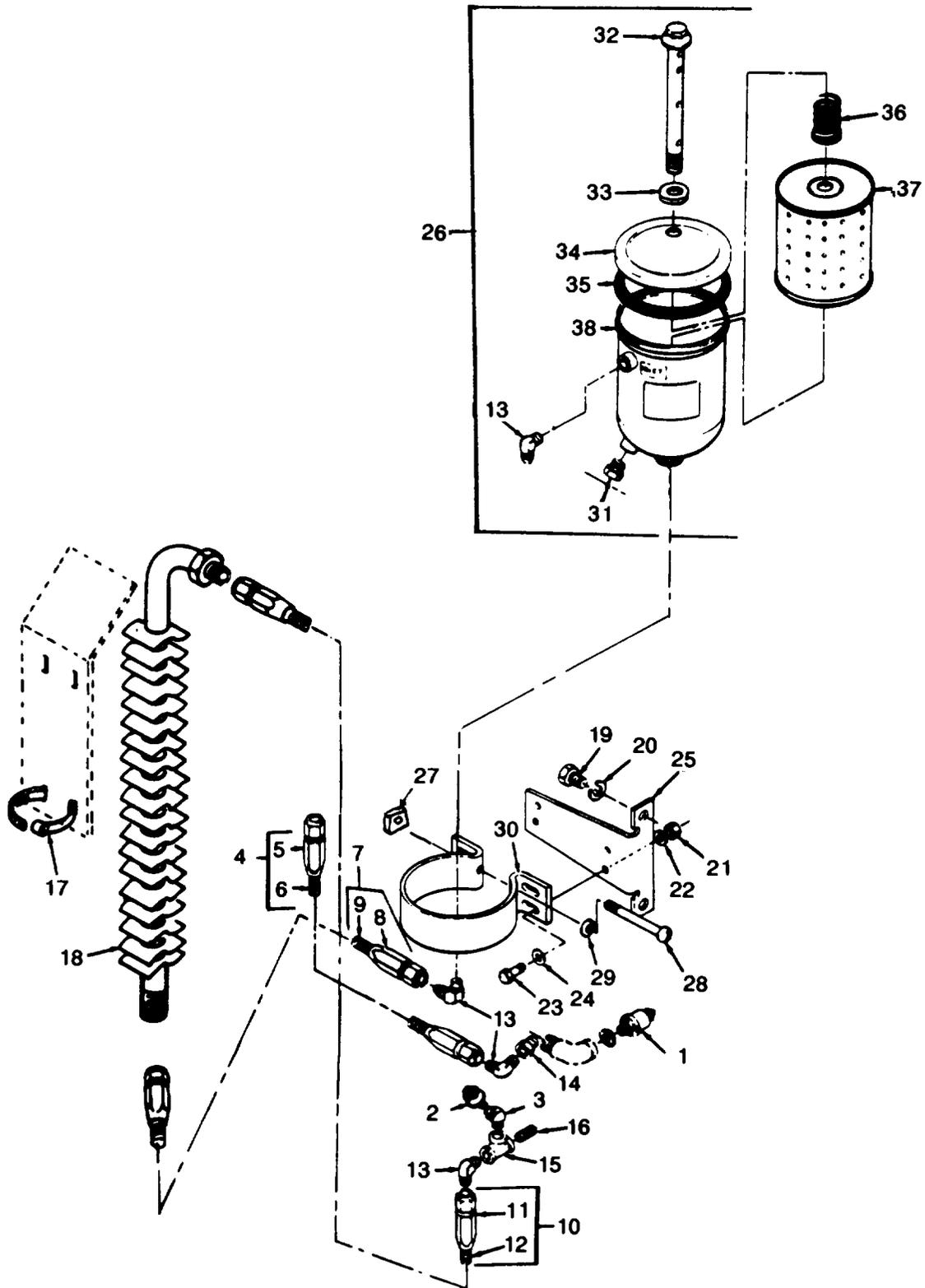

Figure 63. Oil filter and sensors.

(1) ILLUSTRATION A FIG. NO.	(2) SMR CODE B ITEM NO.	A	B	C	D	(3)		(4) NATIONAL STOCK NUMBER	(5) DESCRIPTION REF NUMBER & MFR CODE	(6) USABLE ON CODE U/M	(7) QTY INC IN UNITS	(8) USMC QTY PER EQUIP		
						A	B							
63	1	PAOZZ	PAOZZ	PAGZZ	PAOZZ			.050	6620-01-154-8425	TRANSMITTER: OIL PRESSURE 69-779-1 30554 506-AL 57733	EA	1	1	
63	2	PAOZZ	PAOZZ	PAGZZ	PAOZZ			.050	5930-00-621-7133	SWITCH, SAFETY: OIL PRESSURE 72-2278 30554 SP-2Z-17FA 85814	EA	1	1	
63	3	PAOZZ	PAOZZ	PAGZZ	PAOZZ	D		.006		ELBOW, PIPE: SAFETY SWITCH 6939A 28265	EA	1	1	
63	4	MFFZZ	AOO	AGGGG	MFDZZ					LINE ASSEMBLY: OIL FILTER 206-2838-A5 28265 MANUFACTURE FROM:	EA	1	1	
63	5	PAFZZ	PAOZZ	PAGZZ	PAOZZ	D		.008	4730-00-842-2202	FITTING, HOSE MS24587-8 96906	EA	2	2	
63	6	PAFZZ	PAOZZ	PAGZZ	PAOZZ	D		.070	4720-00-542-4433	HOSE, FUEL MILH8794-8 81349	FT	2	4	
63	7	MFFZZ	PAOZZ	AGGGG	MFOZZ					HOSE ASSEMBLY, OIL: COOLER TO FILTER MS28741-8-0120 96906 MANUFACTURE FROM:	CLC,DGG	EA	1	1
63	8	PAFZZ	PAOZZ	PAGZZ	PAOZZ	D		.047	4730-00-842-2202	FITTING MS24578-8 96906	CLC,DGG	EA	2	
63	9	PAFZZ	PAOZZ	PAGZZ	PAOZZ	D		.070	4720-00-542-4433	HOSE MILH8794-8 81349	CLC,DGG	FT	V	
63	10	MFFZZ	PAOZZ	AGGGG	MFOZZ					HOSE ASSEMBLY, OIL: COOLER TO BLOCK MS28741-5-0220 96906 MANUFACTURE FROM:	CLC	EA	4	
63	10	MFFZZ	PAOZZ	AGGGG	MFOZZ					HOSE ASSEMBLY, OIL: COOLER TO BLOCK MS28741-5-0020 96906 MANUFACTURE FROM:	CLC	EA	4	
63	10	MFFZZ	PAOZZ		MFOZZ					HOSE ASSEMBLY, OIL: COOLER TO BLOCK MS28741-8-0220 96906 MANUFACTURE FROM:	CGG	EA	4	
63	11	PAFZZ	PAOZZ	PAGZZ	PAOZZ	D		.047	4730-00-842-2202	FITTING MS24587-8 96906	CLC	EA	2	
63	11	PAFZZ	PAOZZ		PAOZZ	D		.047	4730-00-842-2202	FITTING MS24587-5 96906	DGG	EA	2	
63	12	PAFZZ	PAOZZ		PAOZZ	D		.070	4730-00-289-9197	HOSE MILH8794-5 81349	DGG	FT	V	
63	12	PAFZZ	PAOZZ	PAGZZ	PAOZZ	D		.070	4720-00-542-4433	HOSE MILH8794-8 96906	CLC	FT		
63	13	PAFZZ	PAOZZ	PAGZZ	PAOZZ	D		.006	4730-00-359-3103	ELBOW 206728A 28265 MS1504-B-8 28265 10460 89749	EA	4		
63	14	XBFZZ	PAOZZ	XBGZZ	XBOZZ				4730-00-289-4736	ADAPTER: OIL HOSE TO BLOCK 3200X6 79470	EA	1	1	
63	15	PAFZZ	XO	PAGZZ	PAOZZ	D		.006		TEE, PIPE OIL LINE TO BLOCK 3200X6 45681	EA	1		
63	16	PAFZZ	XC	PAGZZ	PAOZZ	D		.047		NIPPLE, PIPE OIL LINE TO BLOCK 8FTX 45681	EA	1		
63	17	PAFZZ	PAOZZ	PAGZZ	PAOZZ	D		.008	4730-00-908-3193	CLAMP, HOSE OIL COOLER MTG MS35842-12 96906	CLC,DGG	EA	2	2

TM 9-6115-465-24P
TO 35C2-3-446-4
NAVFAC P-8-625-24P
SL-4-06858B/06859D

(1) ILLUSTRATION		(2) SMR CODE				(3)		(4)	(5) DESCRIPTION		(6)	(7)	(8)
a	b	a	b	c	d	a	b	NATIONAL STOCK NUMBER	REF NUMBER & MFR CODE	USABLE ON CODE	U/M	QTY INC IN UNIT	USMC QTY PER EQUIP
FIG NO.	ITEM NO.	ARMY	AIR FORCE	NAVY	USMC	SSI	REPL FACTOR						
63	18	PAFZZ	PAOZZ	PAGZZ	PAOZZ	D	.013	2930-01-031-2955	COOLER, OIL 72-2154 30554	CLC, DGG	EA	1	
63	19	PAFZZ	PAOZZ	PAGZZ	PAFZZ	D	.008	5305-00-623-1653	SCREW, CAP, HEXAGON HEAD: BRACKET MTG 3235A 28265		EA	2	2
63	20	PAFZZ	PAOZZ	PAGZZ	PAFZZ	D	.010	5310-00-820-6653	WASHER, LOCK: BRACKET 3235A 28265		EA	2	2
63	21	PAFZZ	PAOZZ	XBOZZ	PAFZZ	D	.008	5310-00-615-1835	NUT, PLAIN, HEXAGON OIL FILTER MTG 201814A 28265		EA	4	4
63	22	PAFZZ	PAOZZ	XBGZZ	PAFZZ	D	.008	5310-00-478-3040	WASHER, LOCK OIL FILTER MTG 201400A 28265 104 94607		EA	4	4
63	23	PAFZZ	PAOZZ	PAOZZ	PAFZZ	D	.008	5306-00-225-8497	BOLT MACHINE OIL FILTER MTG MS90725-32 96906		EA	4	44
63	24	PAFZZ	PAOZZ	XBGZZ	PAFZZ	D	.008	5306-00-225-8497	WASHER, FLAT OIL FILTER MTG 20138A 28265		EA	4	4
63	25	XBFZZ	PAOZZ	XBGZZ	XBFZZ	-	-		BRACKET FILTER 290777C 28265		EA	1	1
63	26	PAOZZ	PAOZZ	PAGZZ	PAOOO	-	.700	2940-00-720-4959	OIL FILTER ASSEMBLY 143768 78370 FH6PLMIL		EA	1	1
63	27	PAOZZ	PAOZZ	XBGZZ	PAOZZ	0	.008	-8279	NUT, SQUARE: OIL FILTER STRAP 154746 73370		EA	1	1
63	28	PAOZZ	PAOZZ	XBGZZ	PAOZZ			166	SCREW, MACHINE OIL FILTER STRAP 151392 73370		EA	1	1
63	29	PAOZZ	PAOZZ	XBGZZ				0	WASHER, LOCK OIL FILTER STRAP 23701D0200 81487		EA	1	1
63	30	XBOZZ	XC	XBGZZ					STRAP OIL FILTER MTG 152068 73370		EA	1	1
63	31	XBOZZ	PAOZZ	XBBZZ					PLUG, MACHINE: FILTER DRAIN 151728 73370		EA	1	1
63	32	PAOZZ	PAOZZ	XBGZZ	PAOZZ			6012	BOLT, SPACE VALVE ASSEMBLY 143883 73370		EA	1	1
83	33	PAOZZ	PAOZZ	PAOZZ	PAOZZ			5310-00-297-2275	WASHER, FLAT CENTER BOLT 101979 73370		EA	1	1
63	34	XBOZZ	PAOZZ	XBGZZ	PAOZZ	-	-	2520-00-771-5276	COVER, FILTER 103326 73370		EA	1	1
63	35	PAOZZ	PAOZZ	PAOZZ	PAOZZ	-	2.000		GASKET COVER 440035 91265		EA	1	1
63	36	PAOZZ	PAOZZ	PAOZZ	PAOZZ	D	.015	4330-00-724-1463	SPRING 118940 73370		EA	1	1
63	37	PAOZZ	PAOZZ	PAOZZ	PAOZZ	-	2.000	2940-00-580-6304	CARTRIDGE, ELEMENT MS35802-2 96906		EA	1	1
63	38	XAOZZ	PAOZZ	XAGZZ	XAOZZ	-	-		BODY 150015 73370		EA	1	1

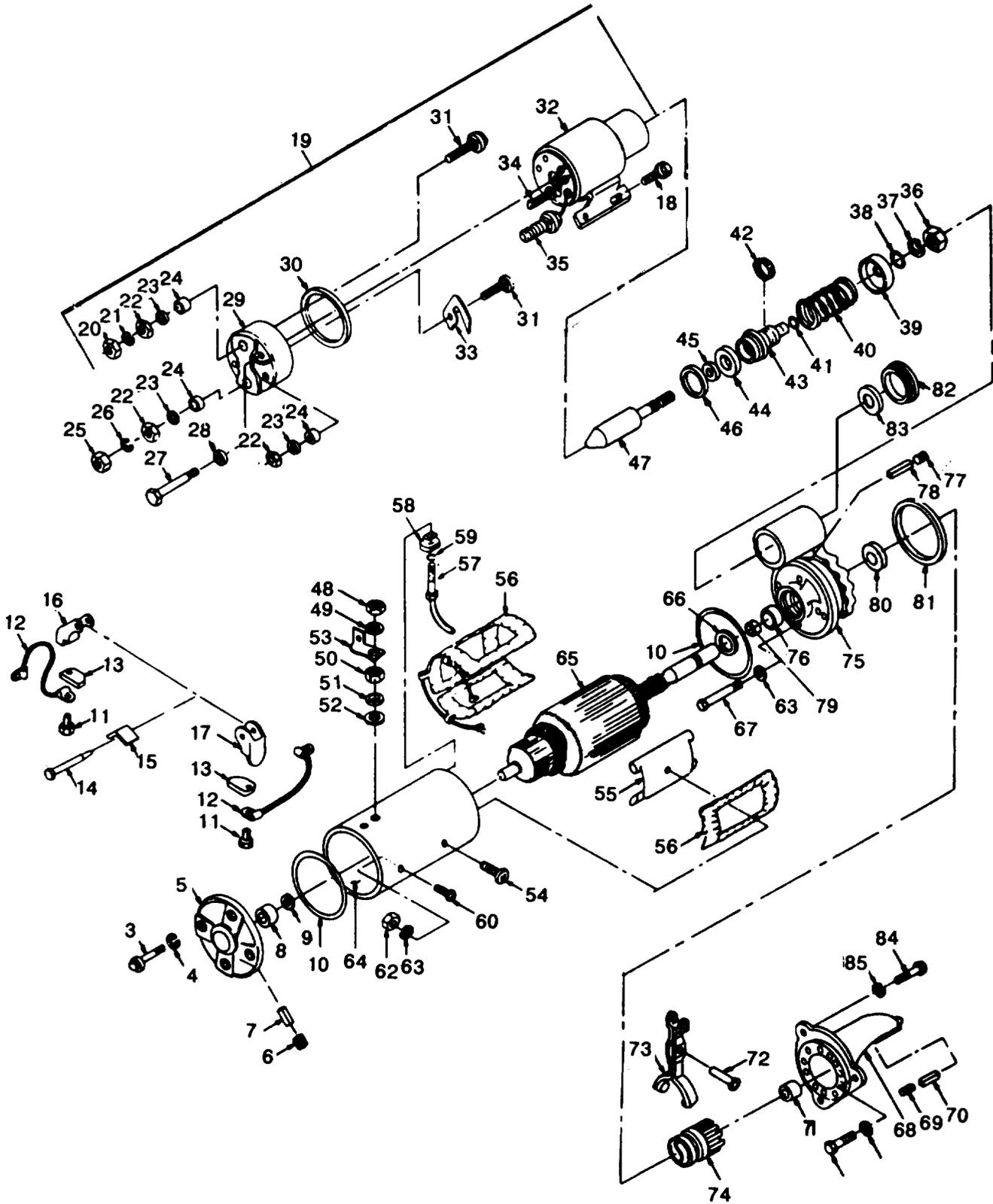

Figure 64. Starter assembly.

(1) ILLUSTRATION		(2) SMR CODE			(3)		(4)	(5)	(6)	(7)	(8)	
A	B	A	B	C	D	A	B	NATIONAL STOCK NUMBER	DESCRIPTION	USABLE ON CODE	QTY INC IN UNITS	USMC QTY PER EQUIP
FIG. NO.	ITEM NO.	ARMY	AIR FORCE	NAVY	USMC	SSI	REPL FACTOR	REF NUMBER & MFR CODE		U/M		
64	1	PAOZZ	PAOZZ		PAFZZ	D	.008	5305-01-014-4250	SCREW, CAP, HEXAGON HEAD STARTER MTF 201753A 28265	EA	3	3
64	2	PAOZZ	PAOZZ		PAFZZ	D	.010	5310-00-630-2802	WASHER, LOCK: STARTER MTG 201568A 28265	EA	3	3
64		PAOFH	PAOFF		PAFHH		.350	2920-01-105-2053	STARTER, ENGINE 75-0889 30554	EA	1	1
64	3	PAFZZ	PAOZZ		PAHZZ	D	.008	5306-00-550-9129	BOLT, FRAME MTG 1914869 16764	EA	4	4
64	4	PAFZZ	PAOZZ		PAHZZ	D	.010	2815-00-921-5366	WASHER, LOCK 9421423 16764	EA	4	4
64	5	XBFZZ	XBOZZ		XBHZZ				END, FRAME 1891925 16764	EA	1	1
64	6	XBFZZ	PAOZZ		PAFZZ	D	.008	4730-00-044-4688	PLUG, PIPE: OIL WICK 9427882 16764	EA	1	1
64	7	PAFZZ	PAOZZ		PAFZZ	D	.013	2920-01-054-3984	WICK, OIL 1891928 16764	EA	1	1
64	8	PAFZZ	PAOZZ		PAFZZ	D	.050	3120-01-051-2619	BUSHING: END FRAME 1891927 16764	EA	1	1
64	9	PAFZZ	PAOZZ		PAHZZ	D	.010	5310-00-178-9612	WASHER, SPACER 1914824 16764	EA	1	1
64	10	PAFZZ	PAOZZ		PAHZZ	D	.040	5330-00-599-2321	PACKING, PREFORMED END FRAME 1916272 16764	EA	2	2
64	11	PAFZZ	PAOZZ		PAHZZ	D	.008	5305-00-900-8496	SCREW, WASHER: BRUSH MTG 1959514 16764	EA	4	4
64	12	PAFZZ	PAOZZ		PAHZZ	D	.023	2920-00-502-1243	LEAD, GROUND 1930694 16764	EA	2	2
64	13	PAFZZ	PAOZZ	PAHZZ			.047	5977-00-733-9909	BRUSH 1906990 16764	EA	1	1
64	14	XBFZZ	XBOZZ	XBHZZ					PIN, HOLDER 1851977 16764	EA	1	1
64	15	PAFZZ	PAOZZ	PAHZZ		D	.015	5360-00-733-9916	SPRING, BRUSH 1946322 16764	EA	2	2
64	16	XBFZZ	XB	XBHZZ					HOLDER, BRUSH: GROUND 1940477 16764	EA	2	2
64	17	XBFZZ	XB	XBHZZ					HOLDER, BRUSH: INSULATED 1950546 16764	EA	2	2
64	18	PAFZZ	PAOZZ	PAHZZ		D	.008	5306-00-775-5209	BOLT, MAHCINE: SOLENOID SWITCH MTG 1930611 16764	EA	4	4
64	19	PAFZZ	PAOZZ	PAHZZ			.030	2920-00-064-8946	SWITCH SOLENOID 111505 16764	EA	1	1
64	20	PAFZZ	PAOZZ	PAHZZ		D	.008	5310-00-482-8512	NUT, PLAIN, HEXAGON: TERMINAL 9414318 16764	EA	2	2
64	21	PAFZZ	PAOZZ	PAHZZ		D	.010	5310-00-045-3296	WASHER, LOCK TERMINAL 453296 16764	EA	2	2
64	22	PAFZZ	PAOZZ	PAHZZ		D	.008	5310-00-013-5787	NUT, PLAIN: HEXAGON: TERMINAL 1949671 16764	EA	3	3

(1) ILLUSTRATION		(2) SMR CODE		(3)			(4)	(5)	(6)	(7)	(8)	
A	B	A	B	C	D	A	B	NATIONAL STOCK NUMBER	DESCRIPTION	USABLE ON CODE	QTY INC IN UNITS	USMC QTY PER EQUIP
FIG. NO.	ITEM NO.	ARMY	AIR FORCE	NAVY	USMC	SSI	REPL FACTOR	REF NUMBER & MFR CODE		U/M		
64	23	PAFZZ	PAOZZ	PAHZZ		D	.010	5310-00-702-1797	WASHER, FLAT: TERMINAL BACWIOAKWP6 98973	EA	2	1
64	24	PAFZZ	PAOZZ		PAHZZ	D	.010	5310-00-058-5269	WASHER, TERMINAL 1950064 16764	EA	2	2
64	25	PAFZZ	PAOZZ		PAHZZ	D	.008	5310-00-934-9751	NUT, PLAIN, HEXAGON MS35650-302 96906	EA	1	1
64	26	PAFZZ	PAOZZ		PAHZZ	D	.010	5310-00-637-9541	WASHER, LOCK MS35338-46 96906	EA	1	1
64	27	PAFZZ	PAOZZ		PAHZZ	D	.008	5306-01-017-1574	SCREW, MACHINE: COVER MTG 453464 16764	EA	2	2
64	28	PAFZZ	PAOZZ		PAHZZ	D	.010	6310-00-167-0834	WASHER, FLAT: COVER MTG 1923935 16764	EA	2	2
64	29	XBFZZ	XA		XBHZZ				COVER, CONTACT 1962538 16764	EA	1	1
64	30	PAFZZ	PAOZZ		PAHZZ		.040	5330-00-061-8358	GASKET:COVER 1965625 16764	EA	1	1
64	31	PAFZZ	PAOZZ		PAHZZ	D	.008	5940-00-891-5990	SCREW, TERMINAL 1958751 16764	EA	1	1
64	32	XAFZZ	XA		XAHZZ				CASE COIL ASSEMBLY 1962532 16764	EA	1	1
64	33	XBFZZ	MOO		XBHZZ				CLIP, TERMINAL 1958287 16764	EA	1	1
64	34	PAFZZ	PAOZZ		XAHZZ			5940-00-061-6298	SCREW, TERMINAL 1958754 16764	EA	1	1
64	35	PAFZZ	PAOZZ		XAHZZ			5306-00-056-4171	SCREW, TERMINAL 1960248 16764	EA	1	1
64	36	PAFZZ	PAOZZ		PAHZZ	D	.008	5310-01-055-4400	NUT, ADJUSTING 1851995 16764	EA	1	1
64	37	PAFZZ	PAOZZ		PAHZZ	D	.013	5365-00-715-1152	RING, SNAP: RETAINER 9415235 16764	EA	1	1
64	38	PAFZZ	PAOZZ		PAHZZ		.040	5330-00-997-9020	PACKING, PREFORMED 1921805 16764	EA	1	1
64	39	PAFZZ	PAOZZ		PAHZZ	D	.010	5310-00-822-2241	WASHER, RECESSED: RETAINER 1948526 16784	EA	1	1
64	40	PAFZZ	PAOZZ		PAHZZ	D	.016	5360-00-812-0196	SPRING, LEVER 1948521 16764	EA	1	1
64	41	PAFZZ	PAOZZ		PAHZZ		.040	6330-00-260-9311	PACKING PREFORMED 1914373 16764	EA	1	1
64	42	PAFZZ	PAOZZ		PAHZZ	D	.013	4730-00-277-6320	CLAMP, BOOT: HOSE 801078 16764	EA	1	1
64	43	PAFZZ	PAOZZ		PAHZZ	D	.023	2920-00-839-1864	BOOT, PLUNGER 801077 16764	EA	1	1
64	44	PAFZZ	PAOZZ	PAHZZ		D	.008	5310-00-822-2236	RETAINER, SPRING 1948520 16784	EA	1	1
64	45	PAFZZ	PAOZZ		PAHZZ	D	.010	5310-00-062-2061	WASHER 1948519 16764	EA	1	1

(1) ILLUSTRATION		(2) SMR CODE		(3)			(4)	(5)	(6)	(7)	(8)	
A	B	A	B	C	D	A	B	NATIONAL STOCK NUMBER	DESCRIPTION	USABLE ON CODE	QTY INC IN UNITS	USMC QTY PER EQUIP
FIG. NO.	ITEM NO.	ARMY	AIR FORCE	NAVY	USMC	SSI	REPL FACTOR	REF NUMBER & MFR CODE		U/M		
64	46	PAFZZ	PAOZZ		PAHZZ	D	.008	5365-00-804-9666	RING, RETAINER 1928022 16764	EA	1	1
64	47	XBFZZ	PAOZZ		XBHZZ				PLUNGER ASSEMBLY, SOLENOID 185196 16764	EA	1	1
64	48	PAFZZ	PAOZZ		PAHZZ	D	.008	5310-00-268-7271	NUT, PLAIN, HEXAGON: TERMINAL 1904419 16764	EA	1	1
64	49	PAFZZ	PAOZZ		PAHZZ	D	.010	5310-00-373-0373	WASHER, LOCK: TERMINAL 9421425 16764	EA	1	1
64	50	PAFZZ	PAOZZ		PAHZZ	D	.008	5310-00-056-3395	NUT, PLAIN, HEXAGON: TERMINAL MS35649-2382 96906	EA	1	1
64	51	PAFZZ	PAOZZ		PAHZZ	D	.010	5310-00-269-5958	WASHER, PLAIN: TERMINAL 1905154 16764	EA	1	1
64	52	PAFZZ	PAOZZ		PAHZZ	D	.010	5310-00-902-1124	WASHER, INSULATION: TERMINAL 1950029 16764	EA	2	2
64	53	XBFZZ	PAOZZ		XBHZZ				CONNECTOR, SOLENOID 1851983 16764	EA	1	1
64	54	PAFZZ	PAOZZ		PAHZZ	D	.008	5303-00-758-8117	SCREW, MACHINE: POLE SHOE 19764294 16764	EA	4	4
64	55	XBHZZ	PAOZZ		XBHZZ				POLE SHOE 1931784 16764	EA	4	4
64	56	PAHZZ	PAOZZ		PAHZZ		.030	2920-01-054-3814	FIELD COIL ASSEMBLY 1867411 16764	EA	1	1
64	57	PAHZZ	PAOZZ		PAHZZ	D	.008	5940-00-614-9461	TERMINAL, STUD 1933879 16764	EA	1	1
64	58	PAHZZ	PAOZZ		PAHZZ	D	.008	5975-00-980-2342	BUSHING, INSULATOR 1931783 16764	EA	1	1
64	59	PAHZZ	PAOZZ		PAHZZ		.040	5330-00-936-5043	GASKET 1946542 16764	EA	1	1
64	60	PAHZZ	PAOZZ		PAHZZ	D	.008	5305-00-984-6212	SCREW, BRUSH SUPPORT MS35206-265 96906	EA	2	2
64	61	XBFZZ	PAOZZ		XBHZZ				RIVET, BRUSH SUPPORT 1945630 16764	EA	2	2
64	62	PAHZZ	PAOZZ		PAHZZ	D	.008	5310-00-934-9758	NUT, BRUSH SUPPORT MS35649-202 96906	EA	2	2
64	63	PAHZZ	PAOZZ		PAHZZ	D	.010	5310-00-476-7648	WASHER, LOCK: BRUSH SUPPORT 453435 16764	EA	6	6
64	64	PAHZZ	PAOZZ		PAHZZ	D	.008	2920-00-737-3225	INSULATION 1914873 16764	EA	2	2
64	65	PAHZZ	PAOZZ		PAHZZ		.050		ARMATURE 1894006 16764	EA	1	1
64	66	XBHZZ	XC		PAHZZ			5310-00-902-1121	WASHER, SPACER 1942283 16764	EA	1	1
64	67	PAHZZ	PAOZZ		PAHZZ	D	.008	5306-01-117-9024	BOLT, HOUSING 184503 16764	EA	6	6
64	68	XBHZZ	PAOZZ		PAHZZ			2920-00-932-9730	HOUSING, DRIVE 1951207 16764	EA	1	1

TM9-6115-465-24P
 TO 35C2-3-446-4
 NAVFAC P-8-625-24P
 SL-4-06858B/06859D

(1) ILLUSTRATION		(2) SMR CODE		(3)			(4) NATIONAL STOCK NUMBER	(5) DESCRIPTION	(6) USABLE ON CODE	(7) QTY INC IN UNITS	(8) USMC QTY PER EQUIP
A FIG. NO.	B ITEM NO.	A ARMY	B AIR FORCE	C NAVY	D USMC	A SSI	B REPL FACTOR	REF NUMBER & MFR CODE	U/M		
64	69	PAFZZ	PAOZZ		PAFZZ	D	.008	4730-00-044-4688 PLUG, PIPE: WICK 9427882 16764	EA	1	2
64	70	PAFZZ	PAOZZ		PAFZZ	D	.023	2920-00-865-8270 WICK, OIL 1916439 16764	EA	1	1
64	71	PAHZZ	PAOZZ		PAHZZ		.050	3120-00-902-2183 BUSHING: END FRAME 1955994 16764	EA	1	1
64	72	XBFZZ	PAOZZ			XBHZZ		LEVER, SHAFT 1851953 16764	EA	1	1
64	73	XBFZZ	XA			XBHZZ		LEVER ASSEMBLY 1851954 16764	EA	1	1
64	74	PAHZZ	PAOZZ		PAHZZ	D	.008	2920-01-058-1026 MOTOR DRIVE, POSITORK 1894107 16764	EA	1	1
64	75	XBHZZ	PAOZZ			XBHZZ		HOUSING, LEVER 1894106 16764	EA	1	1
64	76	PAHZZ	PAOZZ		PAHZZ		.050	3120-00-733-9912 BUSHING, SLEEVE 1933999 16764	EA	1	1
64	77	PAFZZ	PAOZZ		PAFZZ	D	.008	4730-00-044-4688 PLUG, PIPE 9427882 16764	EA	1	2
64	78	PAFZZ	PAOZZ		PAFZZ	D	.023	9390-00-865-8270 WICK, HOUSING, OIL 1916439 16764	EA	1	1
64	79	PAFZZ	PAOZZ		PAHZZ		.040	5330-00-250-5753 SEAL, OIL 1867150 16764	EA	1	1
64	80	XBHZZ	PAOZZ			XBHZZ		WASHER, BRAKE 821453 16764	EA	1	1
64	81	PAHZZ	PAOZZ		PAHZZ		.040	5330-01-113-9678 PACKING, PREFORMED 1851960 16764	EA	1	1
64	82	XBFZZ	PAOZZ		PAHZZ			5365-00-753-9528 PLUG, INSPECTION 1945356 16764	EA	1	1
64	83	PAFZZ	PAOZZ		PAHZZ		.040	5330-00-914-0703 GASKET, PLUG 1964857 16764	EA	1	1
64	84	PAHZZ	PAOZZ		PAHZZ	D	.008	5306-00-550-9129 SCREW, LEVER HOUSING 1914869 16764	EA	5	5
64	85	PAHZZ	PAOZZ		PAHZZ	D	.010	2816-00-921-5366 WASHER, LOCK 9421423 16764	EA	5	5

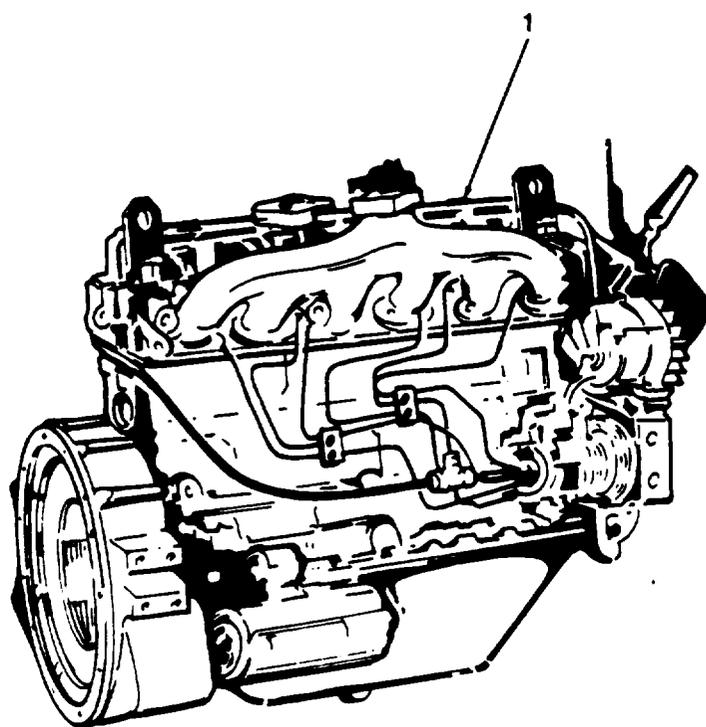

Figure 65. Engine assembly, fuel injection lines and fittings (Sheet 1 of 2).

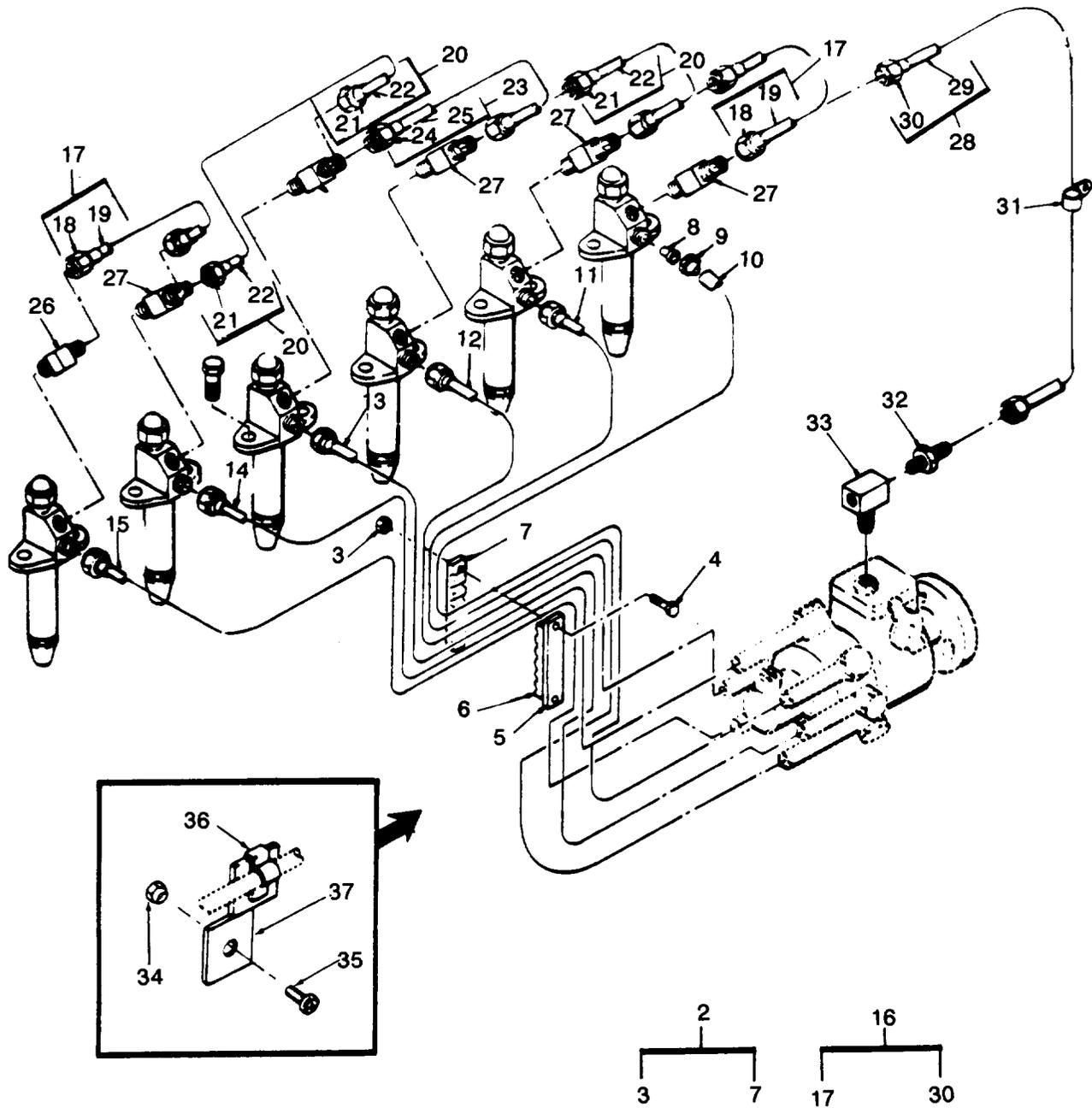

Figure 65. Engine assembly, fuel injection lines and fittings (Sheet 2 of 2).

(1) ILLUSTRATION A	(2) SMR CODE A	B	C	D	(3) A	B	(4) NATIONAL STOCK NUMBER	(5) DESCRIPTION REF NUMBER & MFR CODE	(6) USABLE ON CODE U/M	(7) QTY INC IN UNITS	(8) USMC QTY PER EQUIP	
												B
65	1	PBFFH	PAOZZ	PDDHH	PAFHD	.200	2815-00-501-7001	ENGINE ASSEMBLY 72-2206 30554 D-298-ERX37 28265	EA	1	1	
65	2	PAOZZ	PAOZZ	PAGZZ	PADZZ	.040	2815-01-026-2045	CLAMP ASSEMBLY, FUELINE 40-3092754A 28265	EA	1	1	
65	3	PAOZZ	PAOZZ	PAGZZ	PAOZZ	D	.008	5310-00-953-5600	NUT, LOCK CLAMP 13337A 28265	EA	2	2
65	4	PAOZZ	PAOZZ	XBGZZ	PADZZ	D	.008	5305-00-071-2241	SCREW, CAP, HEXAGON HEAD:CLAMP MS90725-10 96906	EA	2	2
65	5	XAOZZ	XA	XAGZZ	XAOZZ			CLAMP, OUTER 40-0007108A 28265	EA	1	1	
65	6	XAOZZ	XA	XGBZZ	XAOZZ			INSULATION, CLAMP 40-0008501A 28265	EA	2	2	
65	7	XAOZZ	XA	XAGZZ	XAOZZ			CLAMP, INNER 40-0007109A 28265	EA	1	1	
65	8	PAOZZ	PAOZZ	PAGZZ	PAOZZ	D	.008	4730-00-595-4924	NUT, FUELINE 12627A 28265	EA	6	6
65	9	PAOZZ	PAOZZ	PAGZZ	PAOZZ	D	.04	4730-00-052-9877	FERRULE, FUELINE MS39212-3 28265	EA	6	6
65	10	PAOZZ	PAOZZ	PAGZZ	PAOZZ	D	.004	2910-00-611-5171	LINE ASSEMBLY, FUEL 40-3097001 28265	EA	1	1
65	11	PAOZZ	PAOZZ	PBGZZ	PAOZZ	D	.004	2910-00-609-9774	LINE ASSEMBLY, FUEL 40-3097002 28265	EA	1	1
65	12	PAOZZ	PAOZZ	PBGZZ	PAOZZ	D	.004	2910-00-609-9775	LINE ASSEMBLY, FUEL 40-3097003 28265	EA	1	1
65	13	PAOZZ	PAOZZ	PBGZZ	PAOZZ	D	.004	2910-00-609-9779	LINE ASSEMBLY, FUEL 40-3097004 28265	EA	1	1
65	14	PAOZZ	PAOZZ	PBGZZ	PAOZZ	D	.004	2910-00-609-9780	LINE ASSEMBLY, FUEL 40-3097005 28265	EA	1	1
65	15	PAOZZ	PAOZZ	PBGZZ	PAOZZ	D	.004	2910-00-606-0998	LINE ASSEMBLY, FUEL 40-3097006 28265	EA	1	1
65	16	XBOZZ	AOO	AGGGG	XBOZZ			MANIFOLD ASSEMBLY, FUEL 290662AS 28265	EA	1	1	
65	17	PAOZZ	PAOZZ	PAGZZ	PAOZZ	D	.004	4710-00-983-0057	TUBE ASSEMBLY, FUEL: RETURN 290577-AS 28265	EA	1	1
65	18	XAOZZ	XA	XAGZZ	PAOZZ			2910-00-658-3499	NUT: TUBE 1491A 28265	EA	4	12
65	19	XAOZZ	XA	XAGZZ	XAOZZ				TUBE 290577A 28265	EA	1	2
65	20	PAOZZ	PAOZZ	PAGZZ	PAOZZ	D	.004	4710-00-730-1581	TUBE ASSEMBLY, FUEL: RETURN 290515-AS 28265	EA	2	2
65	21	XAOZZ	XA	XAGZZ	PAOZZ			2910-00-658-3499	NUT, TUBE 1491A 28265	EA	4	12
65	22	XAOZZ	XA	XAGZZ	XAOZZ				TUBE, LEAKOFF 290697A 28265	FT	1	

TM 9-6115-465-24P
TO 35C2-3-446-4
NAVFAC P-8-625-24P
SL-4-06858B/06859D

(1) ILLUS- TRATION		(2) SMR CODE				(3)		(4)	(5) DESCRIPTION		(6)	(7)	(8)
a	b	a	b	c	d	a	b	NATIONAL STOCK NUMBER	USABLE ON CODE	U/M	QTY INC IN UNIT	USMC QTY PER EQUIP	
FIG NO.	ITEM NO.	ARMY	AIR FORCE	NAVY	USMC	SSI	REPL FACTOR						REF NUMBER & MFR CODE
65	23	PAOZZ	PAOZZ	PAGZZ	PAOZZ	D	.004	4710-00-730-1579	TUBE ASSEMBLY, FUEL: RETURN 290516AS 28265	EA	1	1	
65	24	XAOZZ	PAOZZ	XAGZZ	PAOZZ	-	-	2910-00-658-3499	NUT, TUBE 1491A 28265	EA	2	12	
65	25	XAOZZ	XA	XAGZZ	XAOZZ	-	-		TUBE 290698A 28265	EA	1	1	
65	26	PAOZZ	PAOZZ	PAGZZ	PAOZZ	D	.008	4730-00-972-1630	ELBOW, PIPE TO TUBE: FUEL RETURN LINE 49X3 79470	EA	1	1	
65	27	PAOZZ	PAOZZ	PAGZZ	PAOZZ	D	.005	4730-00-063-9672	TEE, MANIFOLD: RETURN LINE 51X3 79470	EA	5	5	
65	28	PAOZZ	PAOZZ	XBGZZ	PAOZZ	D	.004	4710-01-025-4687	TUBE ASSEMBLY, FUEL: RETURN 290663AS 28265	EA	1	1	
65	29	PAOZZ	PAOZZ	XAGZZ	PAOZZ	-	-	4730-00-014-4307	NUT, TUBE 1491A 28265	EA	2	12	
65	30	PAOZZ	PAOZZ	XAGZZ	PAOZZ	-	-	4710-00-350-9897	NUT, TUBE 291656A 28265	EA	1	1	
65	31	PAFZZ	PAOZZ	PAGZZ	PAOZZ	D	.008	2990-00-429-0524	CLAMP, TUBE 3734A 28265	EA	1	1	
65	32	PAOZZ	PAOZZ	XBGZZ	PAOZZ	D	.013	4730-00-266-0531	UNION, PIPE TO TUBE 48X3 79470	EA	2	1	
65	33	XBOZZ	PAOZZ	XBGZZ	PAOZZ	D	.008	4730-00-595-0251	TEE, PIPE: PUMP INLET 3600X2 79470	EA	1	1	
85	34	PAOZZ	PAOZZ		PAFZZ	D	.008	5310-00-052-3632	NUT, WASHER ASSEMBLED 69-561-3 30554 511-081800-00 78189	EA	1		
65	35	PAOZZ	PAOZZ		PAFZZ	D	.008	5305-00-984-6193	SCREW, MACHINE MS35206-245 96906	EA	1		
65	36	XBOZZ	PAOZZ		XBFZZ				CLAMP, CABLE 72-2174 30554	EA	1		
65	37	XBOZZ	PAOZZ		XBFZZ				SUPPORT, CONTROL 72-2147 30554	EA	1		

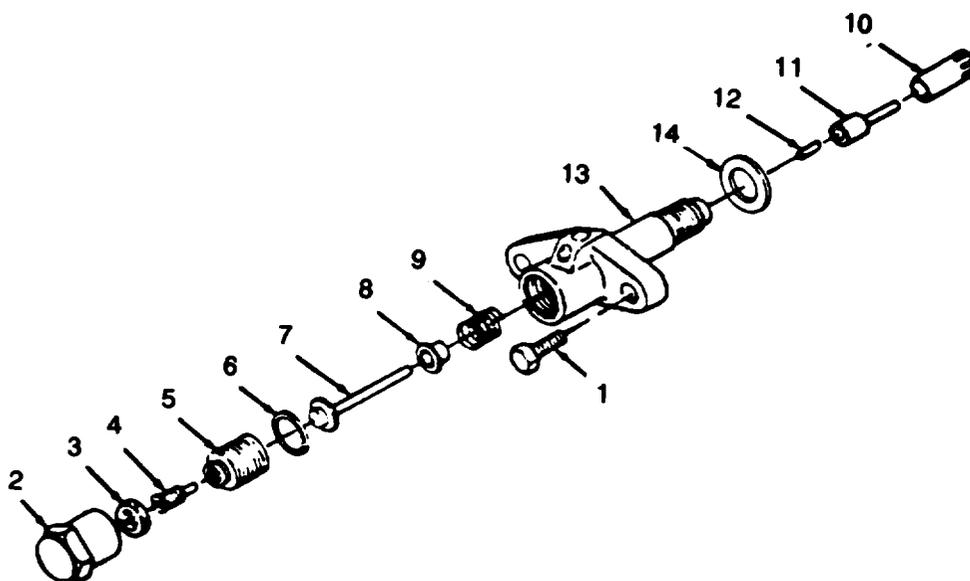

Figure 66. Fuel injector assembly.

(1) ILLUSTRATION		(2) SMR CODE				(3)		(4) NATIONAL STOCK NUMBER	(5) DESCRIPTION	(6) USABLE ON CODE	(7) QTY INC IN UNITS	(8) USMC QTY PER EQUIP
A FIG. NO.	B ITEM NO.	A ARMY	B AIR FORCE	C NAVY	D USMC	A SSI	B REPL FACTOR	REF NUMBER & MFR CODE	U/M			
66	1	PAFZZ	PAOZZ	PAGZZ	PAFZZ	D	.008	5306-00-364-2585	BOLT, MACHINE: INJECTOR MTG 4728A 28265	EA	12	16
66		PAFFF	PAOZZ	PAGGG	PAFHH		1.350	2910-01-035-1355	NOZZLE, HOLDER 40-3055152C 28265	EA	6	6
66	2	PAFZZ	PAOZZ	PAGZZ	PAHZZ	D	.008	5310-01-119-4047	NUT, PLAIN, HEXAGON 7008-34C 55070	EA	6	
66	3	PAFZZ	PAOZZ	PAGZZ	PAHZZ	D	.008		NUT, SELF-LOCKING, HEXAGON 5330-295 55070	EA	6	
66	4	PAFZZ	PAOZZ	PAGZZ	PAHZZ	D	.008	5305-01-038-3722	SCREW, EXTERNALLY RELIEVED BODY 7008-36A 55070	EA	6	
66	5	PAFZZ	PAOZZ	PAGZZ	PAHZZ	D	.008	5310-01-039-3340	NUT, SLEEVE SPRING 7008-35 55070	EA	6	
66	6	PAFZZ	PAOZZ	PAGZZ	PAHZZ	D	.046	2910-00-085-8621	GASKET 5339-334 55070	EA	6	
66	7	PAFZZ	PAOZZ	PAGZZ	PAHZZ	D	.008	2910-01-019-4565	SPINDLE 7008-49T 55070	EA	6	
66	8	PAFZZ	PAOZZ	PAGZZ	PAHZZ	D	.010	2910-01-019-2221	SEAT: SPRING, UPPER 7008-20 55070	EA	6	
66	9	PAFZZ	PAOZZ	PAGZZ	PAHZZ	D	.015	2910-00-894-6410	SPRING: HELICAL COMPRESSION 7008-711 55070	EA	6	
66	10	PAFZZ	PAOZZ	PAGZZ	PAHZZ		.008		NUT, PLAIN KNURLED 7008-571 55070	EA	6	
66	11	PAFZZ	PAOZZ	PAGZZ	PAHZZ		.060	2910-00-971-5568	NOZZLE, FUEL INJECTION 291608-A 28265	EA	6	
66	12	PAFZZ	PAOZZ	PAGZZ	PAHZZ	D	.013		PIN, STRAIGHT, HEADLESS 7008-428 10260	EA	6	
66	13	XAFZZ	PAOZZ	PAGZZ	PAHZZ			2910-01-014-4647	HOLDER ASSEMBLY 40-3055102A 28265	EA	6	6
66	14	PAFZZ	PAOZZ	PAGZZ	PAHZZ			5330-00-167-9009	SEAL (COPPER WASHER) 206752 25255	EA	1	

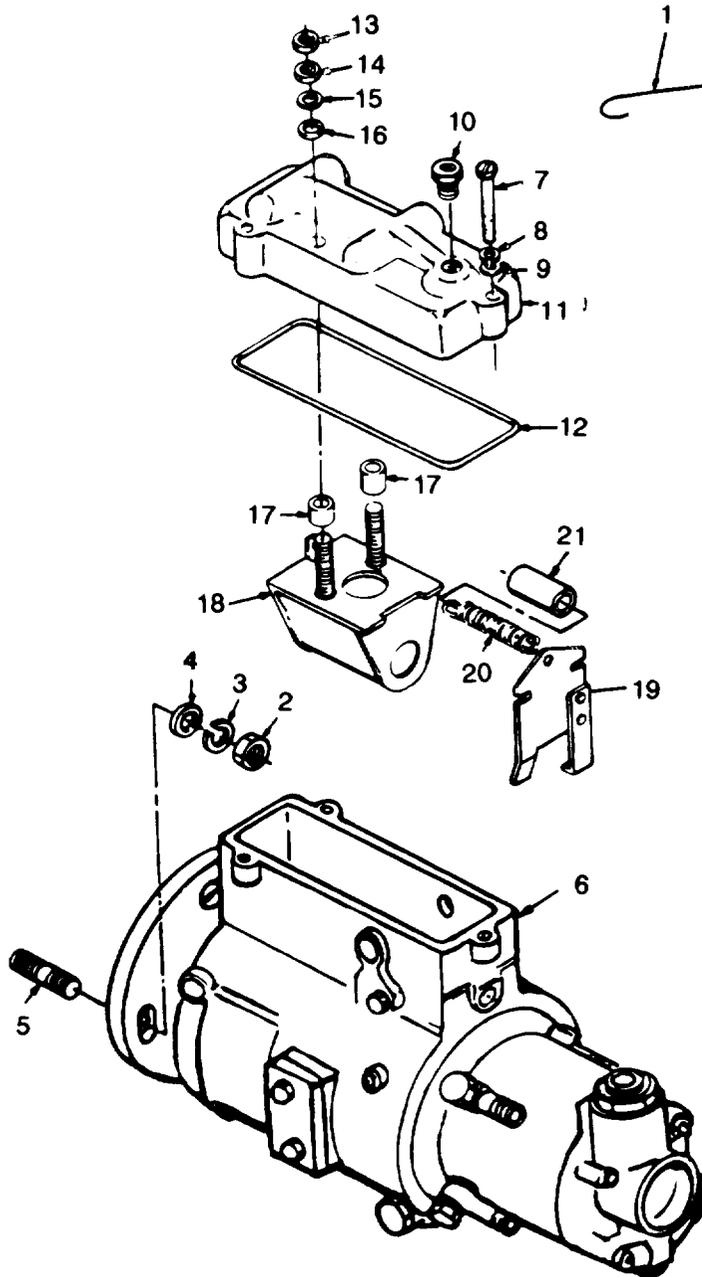

Figure 67. Fuel injection pump governor.

(1) ILLUSTRATION A	(2) SMR CODE A	B	C	D	(3) A	B	(4) NATIONAL STOCK NUMBER	(5) DESCRIPTION REF NUMBER & MFR CODE	(6) USABLE ON CODE U/M	(7) QTY INC IN UNITS	(8) USMC QTY PER EQUIP
67	1	XBFZZ	MOO	XBOZZ	XBFZZ			WIRE, LOCKOUT: GOVERNOR 72-2164 30554 30554-72-2164 36024	FT	2	V
67	2	PAFZZ	PAOZZ	PAGZZ	PAFZZ	D	.008	5310-00-732-0559 NUT, PLAIN, HEXAGON: PUMP MTG MS51968-8 96906	EA	2	
67	3	PAFZZ	PAOZZ	PAGZZ	PAFZZ	D	.010	5310-00-209-0920 WASHER, LOCK: PUMP MTG 342A 28265	EA	2	
67	4	PAFZZ	PAOZZ	PAGZZ	PAFZZ	D	.010	5310-00-209-3671 WASHER, PLAIN: PUMP MTG 2W1-24-24-92 43999	EA	2	2
67	5	XBFZZ	XBGZZ	XBHZZ				STUD, PLAIN: PUMP MTG 6957A 28265	EA	2	2
67	6	PAFFH	PAOZZ	PAHHH	PAFHH		.700	2910-00-499-0818 PUMP, FUEL: INJECTION DBMFC633-1LK 84760	EA	1	1
67	7	PAFZZ	PAOZZ	PAGZZ	PAHZZ	D	.008	5305-00-846-0129 SCREW, MACHINE: COVER MTG MS35265-68 96906	EA	3	3
67	8	PAFZZ	PAOZZ	PAGZZ	PAHZZ	D	.010	5310-00-796-8638 WASHER, LOCK: COVER MTG 11582 87460	EA	3	8
67	9	PAFZZ	PAOZZ	PAGZZ	PAHZZ	D	.010	5310-00-194-0607 WASHER, FLAT: COVER MTG S8153-6-031C 70210	EA	3	7
67	10	PAFZZ	PAOZZ	PAGZZ	PAHZZ	D	.008	4730-00-200-3412 CONNECTOR ASSEMBLY 20154 84760	EA	1	1
67	11	XBFZZ	PAOZZ	KBGZZ	PAHZZ			2910-00-335-9329 COVER, CONTROL 1210G 87460	EA	1	1
67	12	KFFZZ	PAOZZ	KPGZZ	KFHZZ			5330-00-640-9399 GASKET: COVER (PART OF KIT, NSN 5330-00-401-5247) 12054 87460	EA	1	1
67	13	PAFZZ	PAOZZ	PAGZZ	PAHZZ	D	.068	5310-00-807-1466 NUT, LOCK: TERMINAL MS21042-08 96906	EA	2	2
67	14	PAFZZ	PAOZZ	PAGZZ	PAHZZ	D	.008	5310-00-934-9757 NUT, TERMINAL MS35649-282 96906	EA	2	2
67	15	PAFZZ	PAOZZ	PAGZZ	PAHZZ	D	.010	5310-00-461-8858 WASHER, CONTACT 18501 87460	EA	2	2
67	16	PAFZZ	PAOZZ	PAGZZ	PAHZZ	D	.010	5310-00-830-7825 WASHER, INSULATING 12500 87460	EA	2	2
67	17	PAFZZ	PAOZZ	PAGZZ	PAHZZ	D	.023	5330-00-786-4025 TUBE, INSULATING 12513 87460	EA	2	2
67	18	XBFZZ	PAOZZ	XBLZZ	PAHZZ			2910-00-897-2459 FRAME ASSEMBLY 16355 87460	EA	1	1
67	19	XBFZZ	PAOZZ	XBGZZ	PAHZZ			2910-00-832-0122 ARM ASSEMBLY 16278 87460	EA	1	1
67	20	PAFZZ	PAOZZ	PAGZZ	PAHZZ	D	.035	5360-00-691-7207 SPRING, ARM 12480 87460	EA	1	1
67	21	XBFZZ	PAOZZ	PAGZZ	PAHZZ			5365-00-209-3148 SLEEVE 16396 87460	EA	1	1

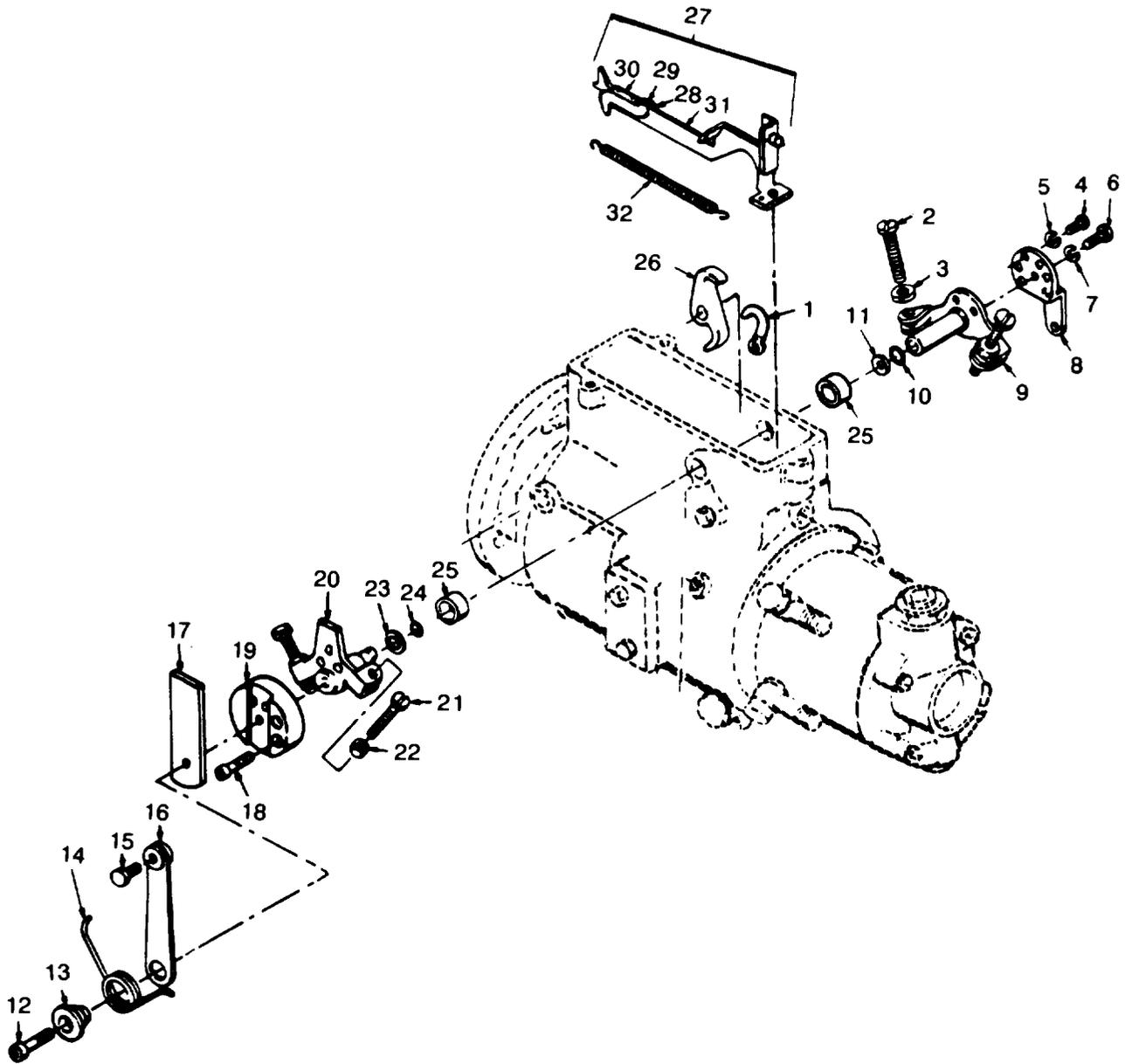

Figure 68. Fuel injection pump linkage and control.

(1) ILLUSTRATION A	(2) SMR CODE A	(3) D	(4) NATIONAL STOCK NUMBER	(5) DESCRIPTION	(6) USABLE ON CODE	(7) QTY INC IN UNITS	(8) USMC QTY PER EQUIP						
								B	C	D	A	B	REF NUMBER & MFR CODE
FIG. NO.	ITEM NO.	ARMY	AIR FORCE	NAVY	USMC	SSI	REPL FACTOR						
68	1	PAFZZ	PAOZZ	PAGZZ	PAHZZ		.009	2910-00-066-2499	CAM ASSEMBLY 14966 87460	EA	1	1	
68	2	PAFZZ	PAOZZ	PAGZZ	PAHZZ	D	.008	5305-00-891-8979	SCREW, MACHINE: ADJUSTING 12972 87460	EA	2	4	
68	3	PAFZZ	PAOZZ	PAGZZ	PAHZZ	D	.008	5310-00-934-9751	NUT, PLAIN, HEXAGON: ADJUSTING SCREW MS35650-32 96906	EA	1	3	
68	4	PAFZZ	PAOZZ	PAGZZ	PAHZZ	D	.008	5305-00-978-9368	SCREW, MACHINE: LEVER MTG MS16997-30 96906	EA	1	2	
68	5	PAFZZ	PAOZZ	PAGZZ	PAHZZ	D	.010	5310-00-559-0070	WASHER, LOCK: ADJUSTING LEVER MS35333-38 96906	EA	1	1	
68	6	PAFZZ	PAOZZ	XBGZZ	PAHZZ	D	.008	5305-01-007-1321	SCREW, MACHINE: ADJUSTING 12998 87460	EA	1	1	
68	7	PAFZZ	PAOZZ	XBGZZ	PAHZZ	D	.010	5310-00-796-8638	WASHER, LOCK: ADJUSTING SCREW 11582 87460	EA	1	8	
68	8	XBFZZ	PAOZZ	PAGZZ	PAHZZ			2910-00-335-9301	LEVER, ADJUSTING 12979 87460	EA	1	1	
68	9	PAFZZ	PAOZZ	PAGZZ	PAHZZ		.021	2910-00-897-2545	SHAFT ASSEMBLY, LEVER 12237 87460	EA	1	1	
68	10	KFFZZ	PAOZZ	KFGZZ	KFHZZ			5330-00-641-8282	SEAL, SHAFT (PART OF KIT,NSN 5330-00-401-5247) 12040 87460	EA	1	2	
68	11	KFFZZ	PAOZZ	KFGZZ	KFFZZ			5310-00-877-4956	WASHER, FLAT: SEAL RETAINER (PART OF KIT, NSN 5330-00-401-5247) 14408 87460	EA	1	2	
68	12	PAFZZ	PAOZZ	PAGZZ	PAHZZ	D	.008	5305-00-638-8859	SCREW, SPRING 887047PC13 10001	EA	1	1	
68	13	PAFZZ	PAFZZ	PAGZZ	PAHZZ	D	.013	5340-00-786-1550	RETAINER, SPRING 13010 87460	EA	1	1	
68	14	PAFZZ	PAOZZ	PAGZZ	PAHZZ		.047	5360-00-751-8916	SPRING, LEVER 13003 87460	EA	1	1	
68	15	PAFZZ	PAOZZ	PAGZZ	PAHZZ	D	.008	5305-00-788-3735	SCREW, CAP, HEXAGON HEAD: LEVER 12957 87460	EA	1	1	
68	16	XBFZZ	PAOZZ	PAGZZ	PAHZZ			2910-00-204-9550	LEVE ASSEMBLY 12949 87460	EA	1	1	
68	17	XBFZZ	PAOZZ	PAGZZ	PAHZZ			2910-00-127-5075	ARM 16136 97460	EA	1	1	
68	18	PAFZZ	PAOZZ	PAGZZ	PAHZZ	D	.008	5305-00-978-9368	SCREW, MACHINE: SPACER MTG MS16997-30 96906	EA	1	2	
68	19	XBFZZ	PAOZZ	PAGZZ	PAGZZ			5340-00-125-6003	SPACER 16136 87460	EA	1	1	
68	20	PAFZZ	PAOZZ	PAGZZ	PAHZZ		.020	2910-00-204-9549	SHAFT ASSEMBLY 17619 87460	EA	1	1	
68	21	PAFZZ	PAOZZ	PAGZZ	PAHZZ	D	.008	5305-00-891-8979	SCREW, MACHINE: ADJUSTING 12972 87460	EA	2	2	
68	22	PAFZZ	PAOZZ	PAGZZ	PAHZZ	D	.008	5310-00-934-9751	NUT, PLAIN, HEXAGON MS35650-302 96906	EA	2	3	

TM9-6115-465-24P
 TO 35C2-3-446-4
 NAVFAC P-8-625-24P
 SL-4-06858B/06859D

(1) ILLUSTRATION		(2) SMR CODE				(3)		(4) NATIONAL STOCK NUMBER	(5) DESCRIPTION	(6) USABLE ON CODE	(7) QTY INC IN UNITS	(8) USMC QTY PER EQUIP
A FIG. NO.	B ITEM NO.	A ARMY	B AIR FORCE	C NAVY	D USMC	A SSI	B REPL FACTOR	REF NUMBER & MFR CODE	U/M			
68	23	PHFZZ	PAOZZ	PAGZZ	KFHZZ		.046	5330-00-641-8282	SEAL, SHAFT 12040 87460	EA	1 2	
68	24	PAFZZ	PAOZZ	PAGZZ	KFHZZ	D	.010	5310-00-877-4956	WASHER, FLAT: SEAL RETAINER 14408 87460	EA	1 2	
68	25	XBFZZ	MOO	XBGZZ	XBHZZ				SPACER, SHAFT 16587 87460	EA	2 2	
68	26	XBFZZ	PAOZZ	PAGZZ	PAHZZ			2910-00-788-0989	LEVER, SHAFT 12221 87460	EA	1 1	
68	27	PAFZZ	PAOZZ	XBGZZ	PAHZZ		.020	2910-00-148-6557	HOOK ASSEMBLY 20226 87460	EA	1 1	
68	28	PAFZZ	PAOZZ	PAGZZ	PAHZZ	D	.008	5305-00-250-5613	SCREW, MACHINE: HOOK 12360 87460	EA	1 1	
68	29	XAFZZ	PAOZZ	PAGZZ	PAHZZ	D	.010	5310-00-410-8585	WASHER, LOCK: HOOK 12362 87462	EA	1 1	
68	30	XAFZZ	PAOZZ	XA	XAHZZ				LINK ASSEMBLY 20225 87460	EA	1 1	
68	31	XAFZZ	PAOZZ	XBGZZ.XAHZZ					HOOK, LINKAGE 17604 87460	EA	1 1	
68	32	PAFZZ	PAOZZ	PAGZZ	PAHZZ		.035	5360-00-335-9237	SPRING 11919 87460	EA	1 1	

TM 9-6115-465-24P
TO 35C2-3-446-4
NAVFAC P-8-625-24P
SL-4-06858B/06859D

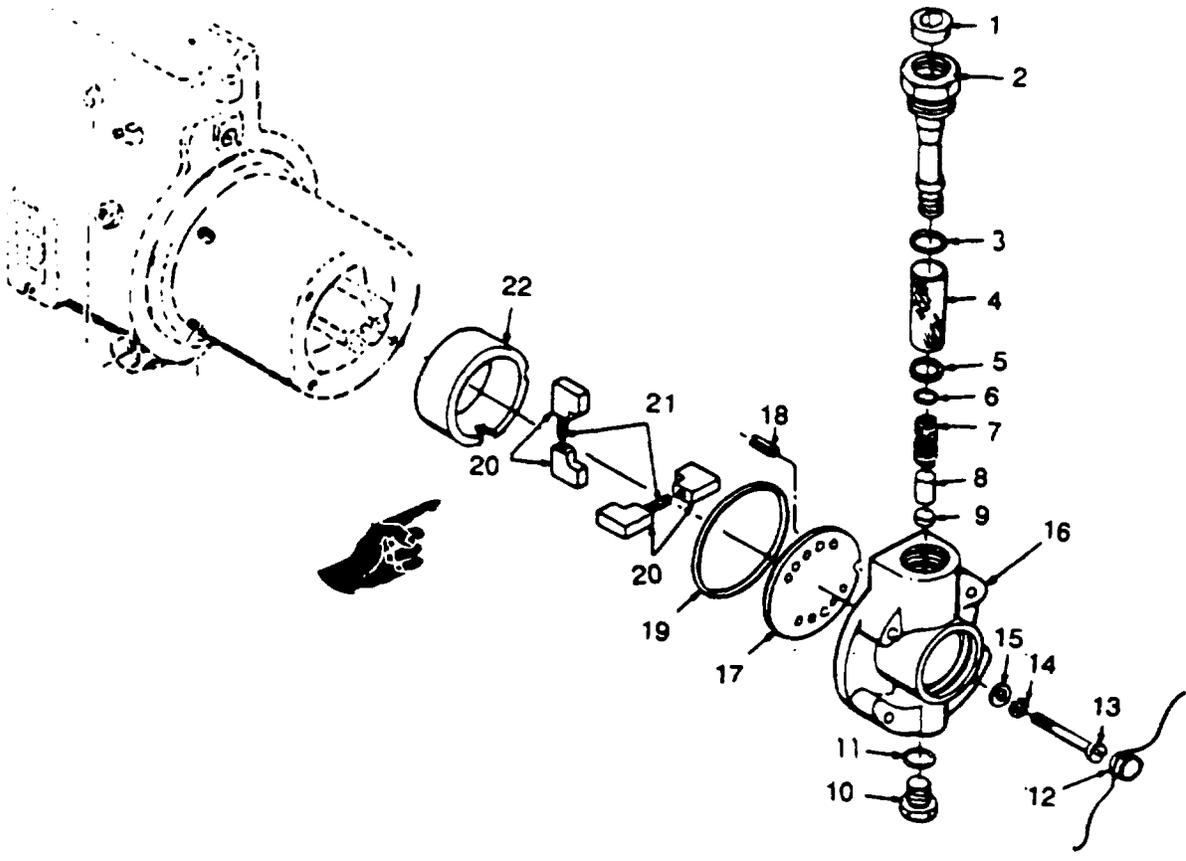

Figure 69. Fuel injection pump end plate and blades.

(1) ILLUSTRATION A FIG. NO.	(2) SMR CODE B ITEM NO.	(3)				(4) NATIONAL STOCK NUMBER	(5) DESCRIPTION REF NUMBER & MFR CODE	(6) USABLE ON CODE U/M	(7) QTY INC IN UNITS	(8) USMC QTY PER EQUIP		
		A ARMY	B AIR FORCE	C NAVY	D USMC							
69	1	PAFZZ	PAOZZ	XBGZZ	PAHZZ	D	.005	4730-00-459-6077	PLUG, PIPE: SLEEVE 15228 87460	EA	1	1
69	2	PAFZZ	PAOZZ	XBGZZ	PAHZZ	D	.008	2910-00-897-2460	SLEEVE, PLATE 17058 87460	EA	1	1
69	3	KFFZZ	PAOZZ	KFGZZ	KFHZZ			5330-00-171-5641	SEAL, END PLATE (PART OF KIT, NSN 5330-00-401-5247) 12406 87460	EA	1	1
69	4	PAFZZ	PAOZZ	PAGZZ	PAHZZ		.040	2910-00-898-4926	ELEMENT: FILTER 15225 87460	EA	1	1
69	5	KFFZZ	PAOZZ	KFGZZ	KFHZZ			2910-00-898-4927	SEAL, ELEMENT (PART OF KIT, NSN 5330-00-401-5247) 87460	EA	1	1
69	6	KFFZZ	PAOZZ	KFGZZ	KFHZZ			5330-00-641-8283	RING, SEAL (PART OF KIT, NSN 5330-00-401-5247) 11507 87460	EA	1	3
69	7	PAFZZ	PAOZZ	PAGZZ	PAHZZ		.015	5300-00-418-4365	SPRING, PISTON 15913 87460	EA	1	1
69	8	PAFZZ	PAOZZ	PAGZZ	PAHZZ	D	.007	2910-00-321-8737	PISTON 11508 87460	EA	1	1
69	9	PAFZZ	PAOZZ	KFGZZ	PAHZZ		.046	2910-00-901-0749	SEAL, PISTON 17056 87460	EA	1	1
69	10	XBFZZ	PAOZZ	XBGZZ	PAHZZ			5365-00-556-7446	PLUG, END PLATE 17451 87460	EA	1	1
69	11	KFFZZ	PAOZZ	PAGZZ	KFHZZ			5330-00-877-4960	SEAL, (PART OF KIT, NSN 5330-00-401-5247) 12966 87460	EA	1	2
69	12	PAFZZ	PAOZZ	PAGZZ	PAHZZ		.040	5310-00-934-9751	SEAL 204607A 87460	EA	1	1
69	13	PAFZZ	PAOZZ	PAGZZ	PAHZZ	D	.008	5305-00-786-4028	SCREW, MACHINE: END PLATE MTG 11532 87460	EA	4	4
69	14	PAFZZ	PAOZZ	PAGZZ	PAHZZ	D	.010	5310-00-796-8638	WASHER, LOCK: END PLATE MTG 11582 87460	EA	4	8
69	15	PAFZZ	PAOZZ	PAGZZ	PAHZZ	D	.010	5310-00-194-0607	WASHER, FLAT: END PLATE MTG S8153-6-031C 70210	EA	4	7
69	16	XBFZZ	PAOZZ	XBGZZ	PAHZZ	D	.008	2990-00-459-7135	PLATE, END 15877 87460	EA	1	1
69	17	XBFZZ	PAOZZ	XBGZZ	PAHZZ	D	.008	2910-00-901-0753	PLATE, TRUST 15875 87460	EA	1	1
69	18	PAFZZ	PAOZZ	PAGZZ	PAHZZ	D	.008	5315-00-992-7084	PIN, ROLL THRUST PLATE 11525 87460	EA	1	1
69	19	KFFZZ	PAOZZ	KFGZZ	KFHZZ			5330-00-853-2376	SEAL, PUMP (PART OF KIT, NSN 5330-00-401-5247) 11329 87460	EA	1	1
69	20	PAFZZ	PAOZZ	XBGZZ	PAHZZ		.020	2910-00-148-6555	BLADE, PUMP 18657 87460	EA	4	4
69	21	PAFZZ	PAOZZ	PAGZZ	PAHZZ		.015	5360-00-900-2564	SPRING, BLADE 15699 87460	EA	2	2
69	22	XBFZZ	PAOZZ	XBOZZ	XBHZZ	D	.008	2910-00-208-6974	LINER, PUMP 18658 87460	EA	1	1

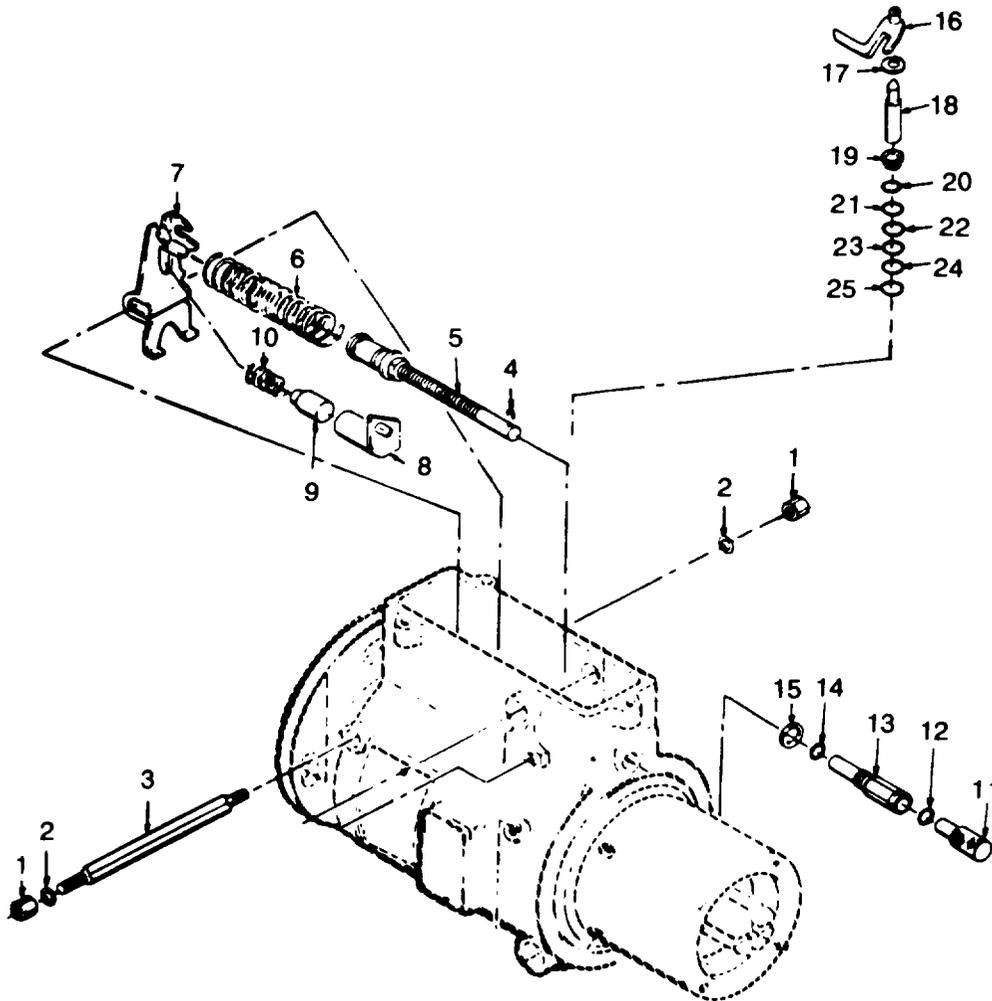

Figure 70. Fuel injection pump, pivot shaft and arm assembly.

(1) ILLUSTRATION A FIG. NO.	(2) SMR CODE B ITEM NO.	A	B	C	D	(3) A SSI	B REPL FACTOR	(4) NATIONAL STOCK NUMBER	(5) DESCRIPTION REF NUMBER & MFR CODE	(6) USABLE ON CODE U/M	(7) QTY INC IN UNITS	(8) USMC QTY PER EQUIP
70	1	PAFZZ	PAOZZ	PAGZZ	PAHZZ	D	.006	5310-00-791-9437	NUT, RETAINING 12288 87460	EA	2	2
70	2	KFFZZ	PAOZZ	KFGZZ	KFHZZ			5330-00-641-8288	SEAL, SHAFT (PART OF KIT, NSN 5330-00-401-5247) 11588 87460	EA	2	2
70	3	PAFZZ	PAOZZ	XBGZZ	PAHZZ		.020	2910-00-148-6552	SHAFT, PIVOT 20224 87460	EA	1	1
70	4	PAFZZ	PAOZZ	PAGZZ	PAHZZ	D	.015	5315-00-786-3998	PIN, SPRING 13554 87460	EA	1	1
70	5	XBFZZ	PAOZZ	XBGZZ	PAHZZ			2910-01-005-6242	ROD ASSEMBLY, CONTROL 18275 87460	EA	1	1
70	6	PAFZZ	PAOZZ	PAGZZ	PAHZZ	D	.015	5360-00-786-1546	SPRING, CONTROL 13558 87460	EA	1	1
70	7	XBFZZ	PAOZZ	XBGZZ	PAHZZ			2910-01-005-5108	ARM ASSEMBLY 20219 87460	EA	1	1
70	8	XBFZZ	PAOZZ	PAGZZ	PAHZZ			2910-00-200-3294	BARREL ASSEMBLY 16568 87460	EA	1	1
70	9	XBFZZ	PAOZZ	PAGZZ	PAHZZ			2910-00-780-0938	PISTON ASSEMBLY 16572 87460	EA	1	1
70	10	XBFZZ	PAOZZ	PAGZZ	PAHZZ			5360-01-022-3146	SPRING, DAMPER 20475 87460	EA	1	1
70	11	XBFZZ	PAOZZ	PAGZZ	PAHZZ			2910-00-786-1565	CAP ASSEMBLY, ADJUSTING 13567 87460	EA	1	1
70	12	PAFZZ	PAOZZ	KFGZZ	PAHZZ		.040	5330-00-877-4960	SEAL, CAP 12966 87460	EA	2	2
70	13	XBFZZ	PAOZZ	XBGZZ	PAHZZ			2910-00-383-5134	GUIDE, CONTROL ROD 20223 87460	EA	1	1
70	14	XBFZZ	PAOZZ	PAGZZ	PAHZZ			5310-00-877-4957	WASHER, GUIDE 13672 87460	EA	1	1
70	15	KFHZZ	PAOZZ	KFGZZ	KFHZZ			5330-00-937-8477	SEAL, GUIDE (PART OF KIT, SNS 5330-00-401-5247) 13550 87460	EA	1	1
70	16	XBFZZ	PAOZZ	PAGZZ	PAHZZ			2910-00-897-2466	ARM ASSEMBLY, VALVE 14680 87460	EA	1	1
70	17	PAFZZ	PAOZZ	PAGZZ	PAHZZ	D	.005	5310-00-877-4952	SHIM, VALVE 11610 87460	EA	1	1
70	18	PAFZZ	PAOZZ	PAGZZ	PAHZZ		.020	2910-01-054-3816	VALVE METERING 20849 87460	EA	1	1
70	19	XBFZZ	PAOZZ	XBGZZ	PAHZZ	D	.008	5365-00-485-0097	SPACER, VALVE 16575 87460	EA	1	1
70	20	XBFZZ	PAOZZ	XBGZZ	XBHZZ				SHIM: VALVE 16576 87460	EA	V	V
70	21	XBFZZ	PAOZZ	XBGZZ	XBHZZ				SHIM: VALVE 19579 87460	EA	V	V

TM9-6115-465-24P
 TO 35C2-3-446-4
 NAVFAC P-8-625-24P
 SL-4-06858B/06859D

(1) ILLUSTRATION		(2) SMR CODE				(3)		(4) NATIONAL STOCK NUMBER	(5) DESCRIPTION	(6) USABLE ON CODE	(7) QTY INC IN UNITS	(8) USMC QTY PER EQUIP
A FIG. NO.	B ITEM NO.	A ARMY	B AIR FORCE	C NAVY	D USMC	A SSI	B REPL FACTOR	REF NUMBER & MFR CODE	U/M			
70	22	XBGZZ	PAOZZ	XBGZZ				SHIM: VALVE 16580 87460	EA	V	V	
70	23	XBFZZ	XB	XBGZZ				SHIM: VALVE 16581 87460	EA	V	V	
70	24	XBFZZ	XB	XBGZZ				SHIM: VALVE 16582 87460	EA	V	V	
70	25	XBFZZ	XB	XBGZZ				SHIM: VALVE 16583 87460	EA	V	V	

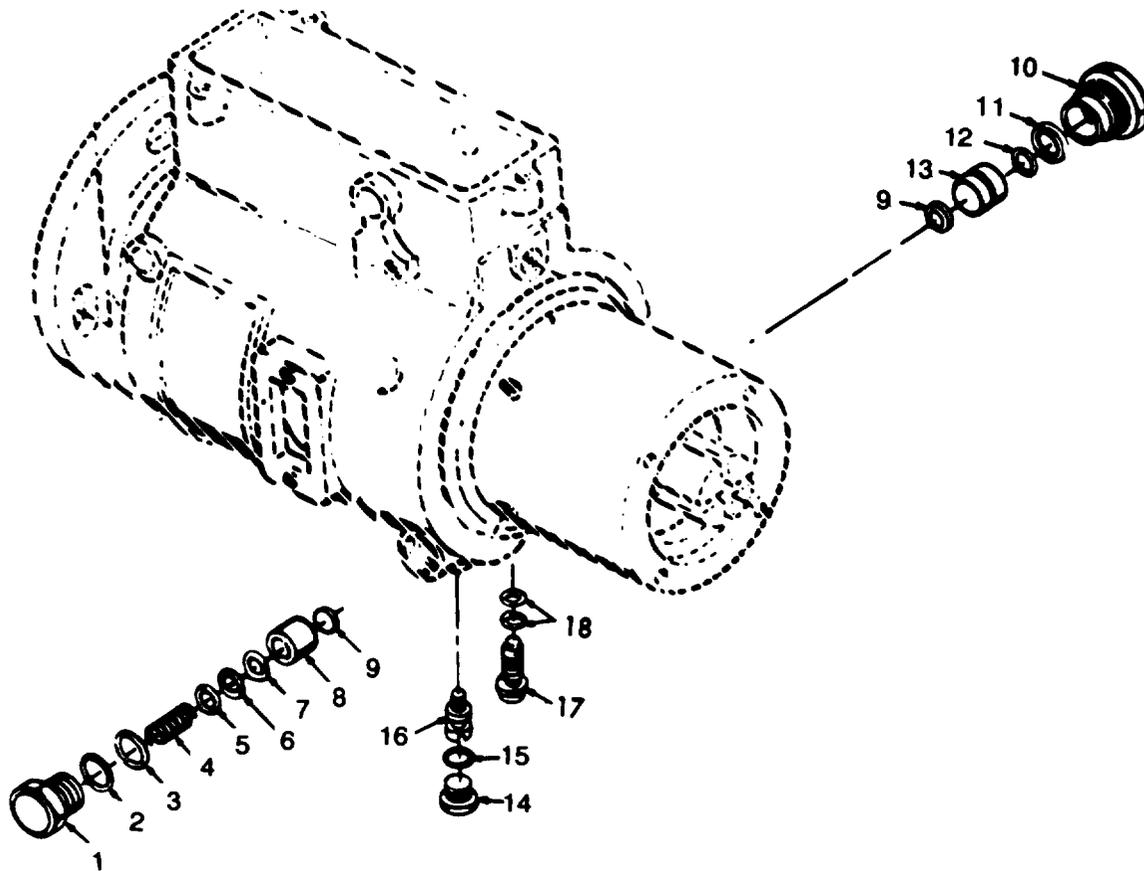

Figure 71. Fuel injection pump piston and damper spring.

(1) ILLUSTRATION		(2) SMR CODE				(3)		(4)	(5)	(6)	(7)	(8)
A	B	A	B	C	D	A	B	NATIONAL STOCK NUMBER	DESCRIPTION	USABLE ON CODE	QTY INC IN UNITS	USMC QTY PER EQUIP
FIG. NO.	ITEM NO.	ARMY	AIR FORCE	NAVY	USMC	SSI	REPL FACTOR		REF NUMBER & MFR CODE	U/M		
71	1	XBFZZ	XBO	XBGZZ					PLUG 12640 87460	EA	1	1
71	2	PAFZZ	PAOZZ	KFGZZ	PAHZZ		.040	5330-01-014-6985	SEAL, PLUG 20113 87460	EA	2	2
71	3	PAFZZ	PAOZZ	KFGZZ	PAHZZ		.040	5330-00-974-6643	SEAL, PLUG 12764 87460	EA	2	2
71	4	PAFZZ	PAOZZ	PAGZZ	PAHZZ	D	.015	5360-00-449-5861	SPRING, ADVANCE 14259 87460	EA	1	1
71	5	XBFZZ	PAOZZ	PAGZZ	PAHZZ			2910-00-786-6343	SHIM 12741 87460	EA	V	V
71	6	XBFZZ	PAOZZ	PAGZZ	PAHZZ			5365-00-441-0249	SHIM 12473 87460	EA	V	V
71	7	XBFZZ	PAOZZ	PAGZZ	PAHZZ			2910-00-980-2301	SHIM 12745 87460	EA	V	V
71	8	PAFZZ	PAOZZ	XBGZZ	PAHZZ	D	.007	2910-01-005-5117	PISTON, SPRING 14733, 87460	EA	1	1
71	9	PAFZZ	PAOZZ	XBGZZ	PAHZZ	D	.010	5310-00-787-8466	WASHER, SLIDE 12622 87460	EA	2	2
71	10	XBFZZ	PAOZZ	XBGZZ	XBHZZ				PLUG 18968 87460	EA	1	1
71	11	PAFZZ	XB	PAGZZ	PAHZZ	D	.008	2910-00-932-4787	RING, PISTON 18967 87460	EA	1	1
71	12	KFFZZ	PAOZZ	KFGZZ	KFHZZ			5330-00-061-8538 5330-00-401-5247)	SEAL, RING (PART OF KIT, NSN 15750 87460	EA	1	1
71	13	PAFZZ	PAOZZ	XBGZZ	PAHZZ	D	.008	2910-01-005-5118	PISTON, POWER 18243 87460	EA	1	1
71	14	XBFZZ	XC	XBGZZ	XBHZZ				PLUG, ADJUSTING 12765 87460	EA	1	1
71	15	KFFZZ	PAOZZ	KFGZZ	KFHZZ			5330-00-936-4587	SEAL, SCREW (PART OF KIT, NSN 5330-00-401-5247) 12766 87460	EA	1	1
71	16	PAFZZ	PAOZZ	PAGZZ	PAHZZ	D	.008	2910-00-787-6428	SCREW, CAM ADJUSTING 15438 87460	EA	1	1
71	17	PAFZZ	PAOZZ	PAGZZ	PAHZZ	D	.008	4820-00-432-1232	SCREW ASSEMBLY 22238 87460	EA	1	1
71	18	KFFZZ	PAOZZ	KFGZZ	KFHZZ			5330-00-641-8283	RING SEAL (PART OF KIT, NSN 5330-00-401-5247) 11507 87460	EA	2	3

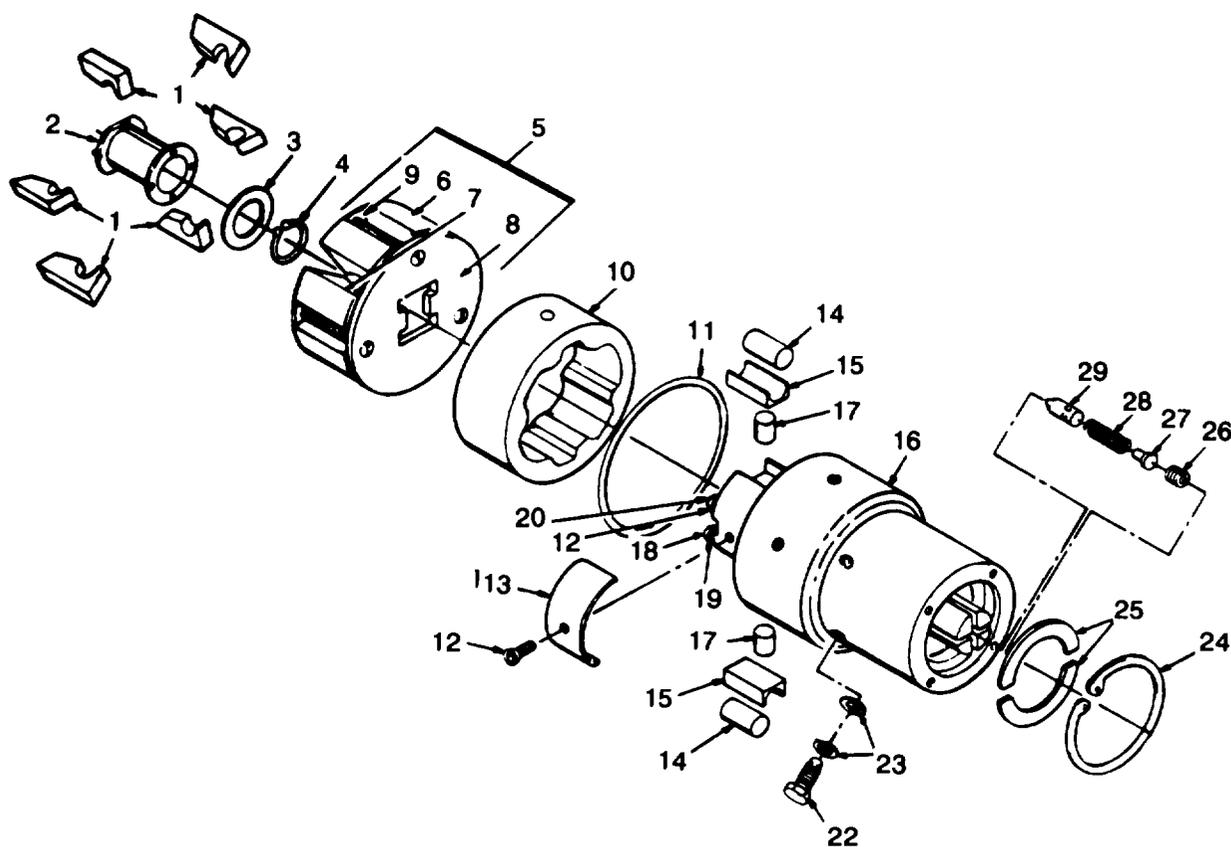

Figure 72. Fuel injection pump rotor assembly.

(1) ILLUSTRATION		(2) SMR CODE				(3)		(4)	(5)	(6)	(7)	(8)
A	B	A	B	C	D	A	B	NATIONAL STOCK NUMBER	DESCRIPTION	USABLE ON CODE	QTY INC IN UNITS	USMC QTY PER EQUIP
FIG. NO.	ITEM NO.	ARMY	AIR FORCE	NAVY	USMC	SSI	REPL FACTOR		REF NUMBER & MFR CODE	U/M		
72	1	XBFZZ	PAOZZ	XBGZZ	PAHZZ			2910-00-289-1528	WEIGHT, GOVERNOR 20214 87460	EA	6	6
72	2	PAFZZ	PAOZZ	XBGZZ	PAHZZ	D	.010	3120-00-886-6208	SLEEVE, THRUST 14483 87460	EA	1	1
72	3	PAFZZ	PAOZZ	XBGZZ	PAHZZ	D	.008	5310-00-393-4067	WASHER, SLEEVE 20222 87460	EA	1	1
72	4	PAFZZ	PAOZZ	PAGZZ	PAHZZ	D	.013	5365-00-282-7145	RING, RETAINING MS16624-93 96906	EA	1	1
72	5	PAFZZ	PAOZZ	XBGZZ	PAHZZ		.020	2910-01-025-0457	RETAINER ASSEMBLY 20237 84760	EA	1	1
72	6	XAFZZ	PAOZZ	XAGZZ	XAHZZ				RETAINER ASSEMBLY 20235 87460	EA	1	1
72	7	XAFZZ	PAOZZ	XAGZZ	XAHZZ				RETAINER 20227 84760	EA	1	1
72	8	XAFZZ	PAOZZ	XAGZZ	XAHZZ				HUD ASSEMBLY 18986 84760	EA	1	1
72	9	XAFZZ	PAOZZ	XAGZZ	XAHZZ				RING 17513 87460	EA	1	1
72	10	XBFZZ	PAOZZ	XBGZZ	XBHZZ				RING, CAM 18785 87460	EA	1	1
72	11	KPFZZ	PAOZZ	KFGZZ	KFHZZ			5330-00-641-8291	SEAL, HEAD (PART OF KIT, NSN 5330-00-401-5247) 11304 87460	EA	1	1
72	12	PAFZZ	PAOZZ	PAGZZ	PAHZZ	D	.008	5305-00-207-3984	SCREW, ADJUSTING 11175 84760	EA	1	
72	13	PAFZZ	PAOZZ	PAGZZ	PAHZZ	D	.005	5360-00-884-8209	SPRING, LEAF 11196 84760	EA	1	1
72	14	PAFZZ	PAOZZ	PAGZZ	PAHZZ	D	.024	5315-00-887-1539	ROLLER, CAM 11141 84760	EA	2	2
72	15	PAFZZ	PAOZZ	XBGZZ	PAHZZ	D	.008	2910-01-005-5986	SHOE, CAM ROLLER 20117 84760	EA	2	2
72	16	XBFZZ	PAOZZ	XAGZZ	PAHZZ				HEAD ROTOR ASSEMBLY 18770 84760	EA	1	1
72	17	XBFZZ	PAOZZ	XAGZZ	XBHZZ				PLUNGER, ROTOR 11076 84760	EA	2	2
72	18	PAFZZ	PAOZZ	XBGZZ	PAHZZ	D	.008	2910-00-887-1547	SCREW 11438 84760	EA	2	2
72	19	PAFZZ	PAOZZ	XDGZZ	PAHZZ	D	.013	2910-00-887-1546	WIRE, VENT 11437 84760	EA	1	1
72	20	PAFZZ	PAOZZ	XBGZZ	PAHZZ	D	.008	2910-00-887-1564	SCREW 12216 87460	EA	1	1
72	21	PAFZZ	PAOZZ	XBGZZ	PAHZZ		.013	2910-00-887-1548	WIRE, RETAINING 11439 84760	EA	1	1
72	22	PAFZZ	PAOZZ	PAGZZ	PAHZZ	D	.008	4730-00-335-9315	BOLT, FLUID PASS 11346 84760	EA	6	6

TM9-6115-465-24P
 TO 35C2-3-446-4
 NAVFAC P-8-625-24P
 SL-4-06858B/06859D

(1) ILLUSTRATION		(2) SMR CODE				(3)		(4) NATIONAL STOCK NUMBER	(5) DESCRIPTION	(6) USABLE ON CODE	(7) QTY INC IN UNITS	(8) USMC QTY PER EQUIP
A FIG. NO.	B ITEM NO.	A ARMY	B AIR FORCE	C NAVY	D USMC	A SSI	B REPL FACTOR	REF NUMBER & MFR CODE	U/M			
72	23	KFFZZ	PAOZZ	KFGZZ	KFHZZ			5310-00-891-8931 WASHER (PART OF KIT, NSN 5330-00-401-5247) 16225 84760	EA	12	12	
72	24	PAFZZ	PAOZZ	PAGZZ	PAHZZ	D	.013	5340-00-786-4027 RING, RETAINER 11208 84760	EA	1	1	
72	25	PAFZZ	PAOZZ	PAGZZ	PAHZZ	D	.013	5365-00-786-3964 RETAINER, ROTOR 11212 84760	EA	2	2	
72	25	PAFZZ	PAOZZ	PAGZZ	PAHZZ	D	.013	5365-00-786-3964 RETAINER, ROTOR 11212 84760	EA	2	2	
72	26	PAFZZ	PAOZZ	PAGZZ	PAHZZ	D	.008	5305-00-786-4032 SCREW, RETAINER 13837 84760	EA	1	1	
72	27	PAFZZ	PAOZZ	XBGZZ	PAHZZ	D	.008	2910-00-897-2461 STOP, VALVE 16440 84760	EA	1	1	
72	28	PAFZZ	PAOZZ	PAGZZ	PAHZZ	D	.015	5360-00-784-0330 SPRING, VALVE 13839 84760	EA	1	1	
72	29	PAFZZ	PAOZZ	PAGZZ	PAHZZ		.023	2910-00-786-1547 VALVE, DELIVERY 13825 84760	EA	1	1	

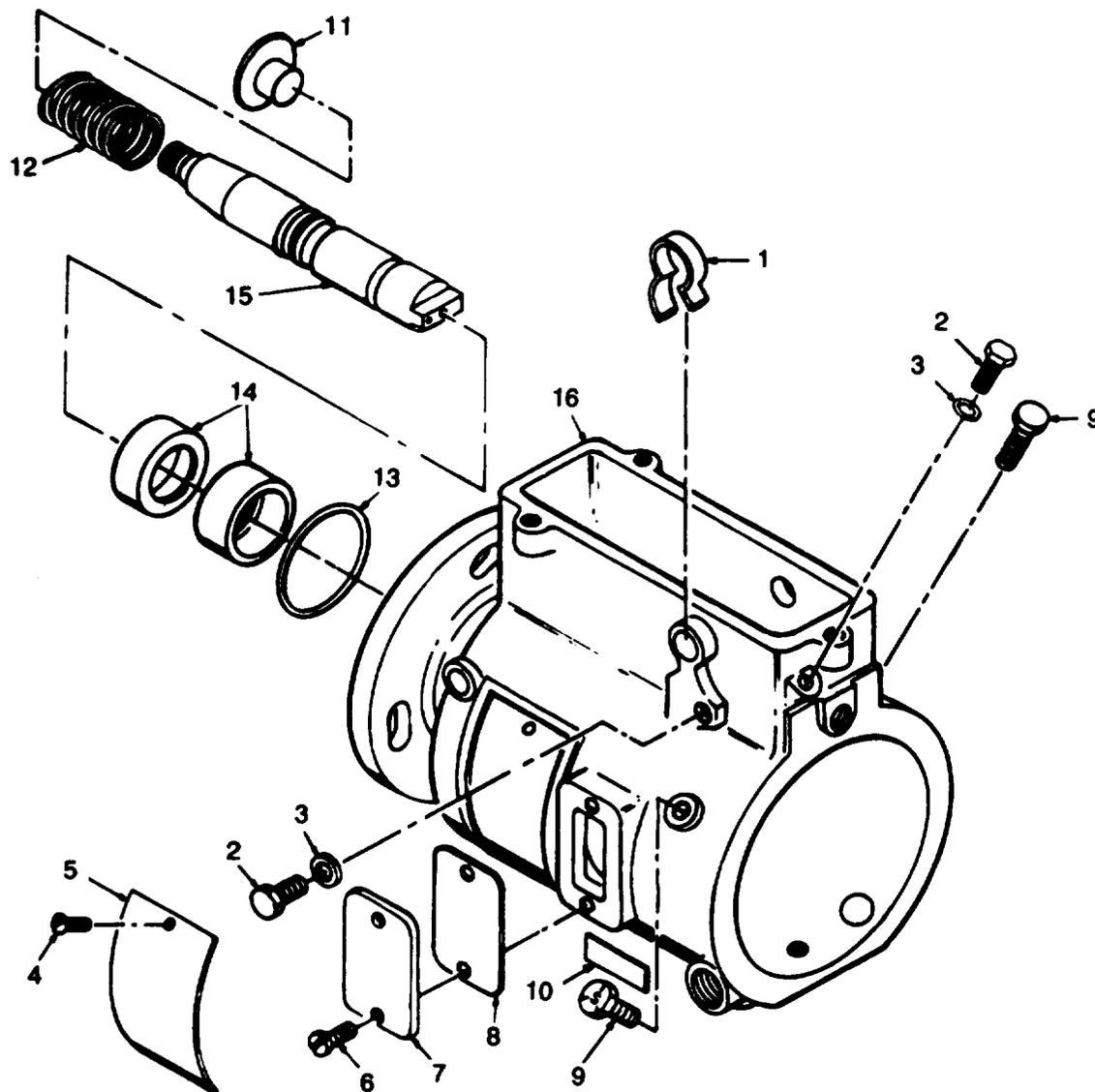

Figure 73. Fuel injection pump housing and drive shaft.

(1) ILLUSTRATION A	(2) SMR CODE B	C	D	(3) A	B	(4) NATIONAL STOCK NUMBER	(5) DESCRIPTION REF NUMBER & MFR CODE	(6) USABLE ON CODE U/M	(7) QTY INC IN UNITS	(8) USMC QTY PER EQUIP		
											A	B
FIG. NO.	ITEM NO.	ARMY	AIR FORCE	NAVY	USMC	SSI	REPL FACTOR					
73	1	PAFZZ	PAOZZ	XBFZZ	PAHZZ	D	.008	5305-00-125-6181	STOP, SCREW 16395 84760	EA	1	1
73	2	PAFZZ	PAOZZ	PAGZZ	PAHZZ	D	.008	5305-00-993-8748	SCREW 12259 84760	EA	2	2
73	3	KFFZZ	KF	KFGZZ	KFHZZ				WASHER (PART OF KIT, NSN 5330-00-401-5247) 10464 84760	EA	2	2
73	4	PAFZZ	PAOZZ	PAGZZ	PAHZZ	D	.008	5305-00-253-5606	SCREW MS21318-7 96906	EA	2	2
73	5	XBFZZ	XBOZZ	KBGZZ	MDOZZ			9905-00-473-6379	PLATE, NAME 10394 84760	EA	1	1
73	6	PAFZZ	PAOZZ	PAGZZ	PAHZZ	D	.008	5305-00-156-2937	SCREW, COVER MS35190-249 96906	EA	4	4
74	7	XBFZZ	PAOZZ	XBGZZ	PAHZZ			2910-00-787-6422	COVER, LINE 10567 84760	EA	2	2
74	8	KFFZZ	PAOZZ	KFHZZ	KFHZZ			5330-00-506-3975	GASKET (PART OF KIT, NSN 5330-00-401-5247) 10574 84760	EA	2	2
73	9	PAFZZ	PAOZZ	PAGZZ	PAHZZ	D	.008	5306-00-819-3038	SCREW, LOCKING 11331 84760	EA	2	2
73	10	XBFZZ	XB	XBGZZ	MDOZZ				PLATE, CAUTION 18948 84760	EA	1	1
73	11	PAFZZ	PAOZZ	PAGZZ	PAHZZ	D	.008	2910-00-133-9877	BUTTON, THRUST 16144 84760	EA	1	1
73	12	PAFZZ	PAOZZ	XBGZZ	PHAZZ		.015	5360-00-887-1536	SPRING, BUTTON 10541 84760	EA	1	1
73	13	KFFZZ	PAOZZ	KFGZZ	KFHZZ			5330-00-877-4972	SEAL, TUBE (PART OF KIT, NSN 5330-00-401-5247) 10519 84760	EA	1	1
73	14	KFFZZ	PAOZZ	KFZZZ	PAHZZ			2910-00-757-1680	SEAL, SHAFT (PART OF KIT, NSN 5330-00-401-5247) 10453 84760	EA	2	2
73	15	PAFZZ	PAOZZ	PAGZZ	PAHZZ		.020	2910-01-005-7064	SHAFT, DRIVE 20238 84760	EA	1	1
73	16	KAFZZ	XA	XAGZZ	XAHZZ				HOUSING ASSEMBLY 17981 84760	EA	1	1

(1) ILLUSTRATION A	(2) SMR CODE A	(3) D	(4) NATIONAL STOCK NUMBER	(5) DESCRIPTION	(6) USABLE ON CODE	(7) QTY INC IN UNITS	(8) USMC QTY PER EQUIP						
								B	C	D	A	B	REF NUMBER & MFR CODE
FIG. NO.	ITEM NO.	ARMY	AIR FORCE	NAVY	USMC	SSI	REPL FACTOR						
74	1	PAOZZ	PAOZZ	XBGZZ	PAFZZ	D	.008	5305-01-014-4262	SCREW, CAP, HEXAGON HEAD: FAN MTG 2359A 28265	EA	4	4	
74	2	PAOZZ	PAOZZ	PAGZZ	PAFZZ	D	.010	5310-00-010-3320	WASHER, LOCK: FAN MTG 615A 28265	EA	2	6	
74	3	PAOZZ	PAOZZ	PBGZZ	PAFZZ	D	.007	2930-01-024-8654	FAN, ENGINE: COOLING 72-2207 30554 8692DX 77890	EA	1	1	
74	4	PAOZZ	PAOZZ	PAGZZ	PAFZZ	D	.008	5305-00-483-0417	BOLT, MACHINE: INLET PIPE MTG 202886A 28265	EA	1	1	
74	5	PAOZZ	PAOZZ	PAGZZ	PAFZZ	D	.010	5310-00-010-3320	WASHER, LOCK: WATER PUMP PIPE 615A 28265	EA	2	6	
74	6	PAOZZ	PAOZZ	PAGZZ	PAFZZ	D	.008	5305-00-782-6238	SCREW, CAP, HEXAGON HEAD: INLET PIPE 204236A 28265	EA	1	1	
74	7	XBOZZ	XC	PAGZZ	XBFFZ				PLUG, PIPE 305A 28265	EA	1	1	
74	8	XBOZZ	XC	PAGZZ	XBFFZ				REDUCER, PIPE 4533A 28265	EA	1	1	
74	9	PAOZZ	PAOZZ	PAGZZ	PAHZZ			2930-00-915-5360	PIPE, INLET: WATER 285718C 28265	EA	1	1	
74	10	PAOZZ	PAOZZ	KFGZZ	PAFZZ		.040	5330-00-678-3817	GASKET: PIPE MTG PART OF KIT, NSN 2930-00-678-3818, ALSO P/N 40-3094661A, AND 4D-3094662A 255365A 28265	EA	1	1	
74	11	XBOZZ	PAOZZ	XBGZZ	PAFZZ	D	.008	4730-00-277-8257	ELBOW, PIPE: INLET PIPE 6939A 28265	EA	1	1	
74	12	PAOZZ	PAOZZ	XBGZZ	PAFZZ	D	.008	5305-01-014-2221	SCREW CAP, HEXAGON HEAD: WATER PUMP MTG 4868A 28265	EA	1	1	
74	13	PAOZZ	PAOZZ	XBGZZ	PAFZZ	D	.008	5306-00-616-5647	BOLT, MACHINE WATER PUMP MTG 204429A 28265	EA	2	2	
74	14	PAOZZ	PAOZZ	PAGZZ	PAFZZ	D	.010	5310-00-033-7566	WASHER LOCK: WATER PUMP MTG 335A 28265	EA	3	3	
74	15	PAFZZ	PAOZZ	PAGZZ	PAFZZ	D	.008	5306-00-225-8497	BOLT, MACHINE: BRACKET TO PUMP MTG MS90725-32 96906	EA	1	44	
74	16	PAFZZ	PAOZZ	PAGZZ	PAFZZ	D	.010	5310-00-407-9566	WASHER, LOCK: BRACKET TO PUMP MTG MS35338-45 96906	EA	1	26	
74	17	XBFFZ	PAOZZ	XBGZZ	XBFFZ				BRACKET: PUMP TO ENGINE 72-2166 30554 40-0019710 28265	EA	1	1	
74	18	PAFZZ	PAOZZ	KFGZZ	PAFZZ		.040	5330-00-649-8445	GASKET: WATER PUMP MTG (PART OF KIT, NSN 2930-00-676-3818, ALSO P/N 40-309-4662A) 255360A 28265	EA	1	1	
74		PAOPZ	PAFZZ	AGGGG	PAFFF		.125	2930-01-013-1768	PUMP ASSEMBLY, WATER 40-3035051DS 28265	EA	1	1	
74	19	XBOZZ	PAOZZ	XBGZZ	PAHZZ			3020-00-623-9196	PULLEY, BELT: WATER PUMP 40-3080201C 28265	EA	1	1	

TM9-6115-465-24P
 TO35CZ-3-446-4
 NAVFAC P-8-625-24P
 SL-4-06858B/06859D

(1) ILLUSTRATION		(2) SMR CODE				(3)		(4) NATIONAL STOCK NUMBER	(5) DESCRIPTION	(6) USABLE ON CODE	(7) QTY INC IN UNITS	(8) USMC QTY PER EQUIP
A FIG. NO.	B ITEM NO.	A ARMY	B AIR FORCE	C NAVY	D USMC	A SSI	B REPL FACTOR	REF NUMBER & MFR CODE	U/M			
74		XAFZZ	PAOFF	PAGGG	PAFZZ		.700	2930-00-855-5403 PUMP, BASIC 2562900S 28265	EA	1	1	
74	20	PAFZZ	PAOZZ	PAGZZ	PAFZZ	D	.008	5305-00-619-2322 SCREW, FLAT HEAD: COVER MTG MS35265-96 96906	EA	6	6	
74	21	XAFZZ	XA	XAGZZ	XAFZZ			COVER, PUMP 255370C 28265	EA	1	1	
74	22	KFFZZ	PAOZZ	KFGZZ	KFFZZ			5330-00-678-3815 GASKET: PUMP COVER (PART OF KIT, NSN 2930-00-678-3818) 255371B 28265	EA	1	1	
74	23	KFFZZ	KF	KFGZZ	KFFZZ			2930-00-718-4727 RING, SNAP: SHAFT RETAINING (PART OF KIT, NSN 2930-00-678-3818) 11944A 28265	EA	1	1	
74	24	KFFZZ	KF	KFGZZ	KFFZZ			2930-00-557-9704 SHAFT, IMPELLER (PART OF KIT, NSN 2930-00-678-3818) 256582A 28265	EA	1	1	
74	25	KFFZZ	KF	KFGZZ	KFFZZ			2930-00-786-1544 IMPELLER, PUMP (PART OF KIT, NSN 2930-00-678-3818) 255361B 28265	EA	1	1	
74	26	KFFZZ	KF	KFGZZ	KFFZZ			2930-00-392-4724 SEAL, PUMP (PART OF KIT, NSN 2930-00-678-3818) 39187BS 28265	EA	1	1	
74	27	XAFZZ	XA	XAGZZ	PAFZZ			2930-00-806-0776 BODY, PUMP 255369F 28265	EA	1	1	

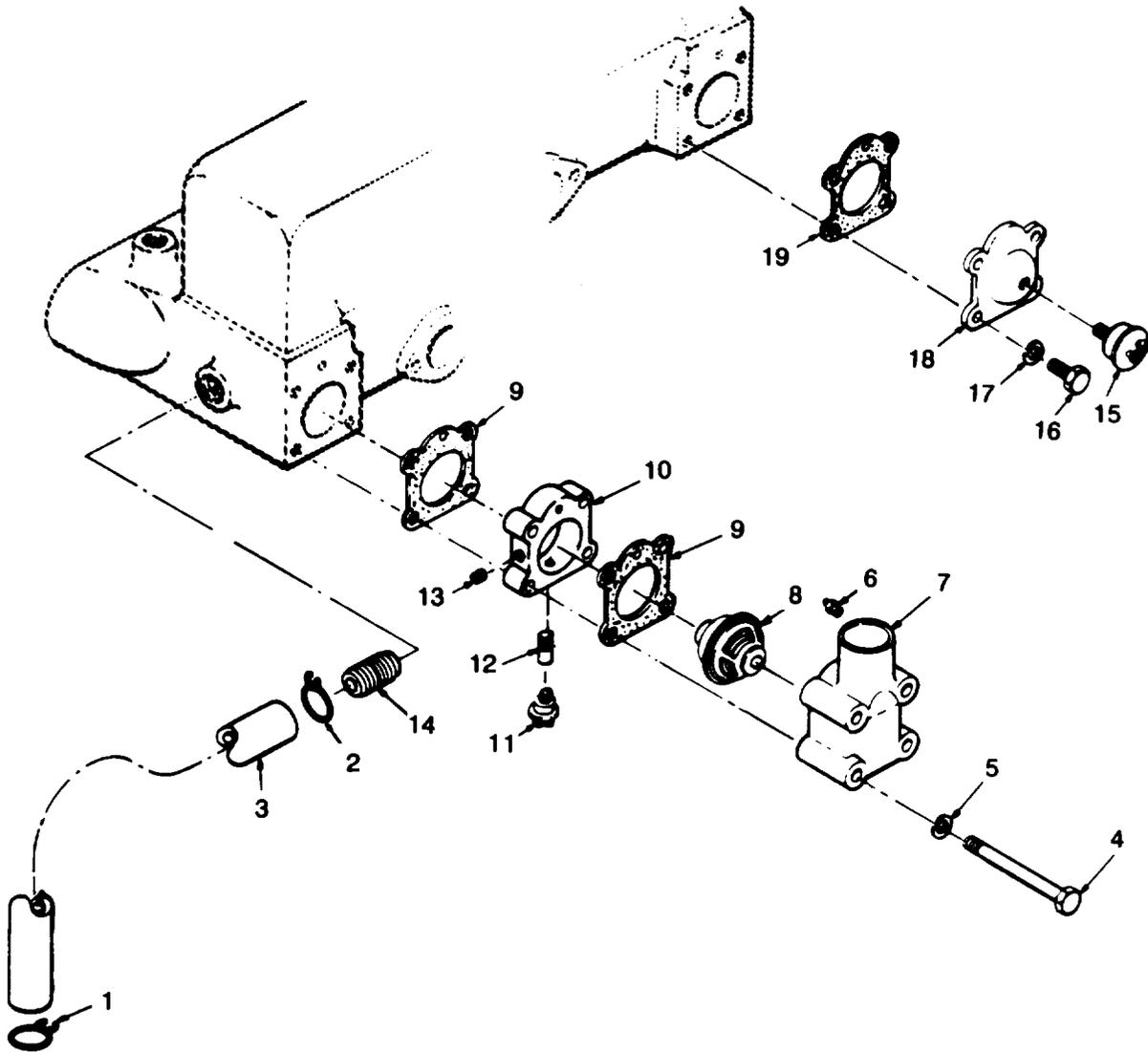

Figure 75. Coolant thermostat and sensors.

**TM 9-6115-465-24P
TO 35C2-3-446-4
NAVFAC P-8-625-24P
SL-4-06858B/06859D**

(1) ILLUS- TRATION		(2) SMR CODE				(3)		(4)	(5) DESCRIPTION		(6)	(7)	(8)
a FIG NO.	b ITEM NO.	a ARMY	b AIR FORCE	c NAVY	d USMC	a SSI	b REPL FACTOR	NATIONAL STOCK NUMBER	REF NUMBER & MFR CODE	USABLE ON CODE	U/M	QTY INC IN UNIT	USMC QTY PER EQUIP
75	1	PAOZZ	PAOZZ	PAOZZ	PAOZZ	D	.013	4730-01-016-5922	CLAMP, HOSE GM42 66295		EA	1	1
75	2	PAOZZ	PAOZZ	PAOZZ	PAOZZ	D	.013	4730-01-013-9363	CLAMP, HOSE 50GM 66295		EA	1	1
75	3	PAOZZ	PAOZZ	PAGZZ	PAOZZ	-	.070	4720-00-997-0136	HOSE, BYPASS 288704-00 28265		EA	1	1
75	4	PAOZZ	PAOZZ	PAGZZ	PAFZZ	D	.008	5305-00-934-0279	SCREW, CAP, HEXAGON HEAD: OUTLET PIPE 202864A 28265		EA	4	4
75	5	PAOZZ	PAOZZ	XBGZZ	PAFZZ	D	.006	5310-00-637-9541	WASHER, LOCK: OUTLET PIPE MS35338-46 96906		EA	4	4
75	6	PAOZZ	PAOZZ	XBGZZ	PAFZZ	D	.008	5340-00-705-7807	PLUG, CUP 203924A 28265		EA	1	1
75	7	XBOZZ	XC	XBGZZ	PAFZZ	-	-	2815-00-477-6001	HOUSING, THERMOSTAT 288750C 28265		EA	1	1
75	8	PAOZZ	PAOZZ	PAGZZ	PAFZZ	-	.050	6620-00-841-1892	THERMOSTAT MS35770-1 96906		EA	1	1
75	9	PAOZZ	PAOZZ	PAGZZ	PAFZZ	-	.040	5330-00-971-5607	GASKET: OUTLET PIPE (ALSO PART OF KIT, P/N 40-3094661A AND 40-3094662A) 266701A 28265		EA	2	3
75	10	PBOZZ	PBOZZ	PBGZZ	PBFZZ	-	-		SPACER, OUTLET PIPE 40-3070401 28265		EA	1	1
75	11	PAOZZ	PAOZZ	PAGZZ	PAFZZ	-	.050	6685-00-814-5271	TRANSMITTER, ROCKER SHAFT TEMPERATURE 69-781 30554		EA	1	1
75	12	PAOZZ	PAOZZ	PAGZZ	PAFZZ	-	-	4730-00-209-1759	ADAPTER SPACER 206880A 28265		EA	1	1
75	13	XBOZZ	PAOZZ	PAOZZ	PAFZZ	-	-	4730-00-834-6187	PLUG, PIPE: SPACER 415A 28265		EA	2	7
75	14	XBOZZ	XC	XBGZZ	PAFZZ	-	-	4730-00-993-3711	NIPPLE, PIPE: BYPASS HOSE 3204A 28265		EA	1	1
75	15	PAOZZ	PAOZZ	PAGZZ	PAFZZ	-	.050	5930-01-009-0953	SWITCH, TEMPERATURE 69-698-4 30554 TC150-222-4ANSL 85814		EA	1	1
75	16	PAOZZ	PAOZZ	XBGZZ	PAFZZ	D	.008	5305-00-616-5649	SCREW, CAPHEXAGON HEAD: COVER PLATE MTG 315A 28265		EA	4	20
75	17	PAFZZ	PAOZZ	XBGZZ	PAFZZ	D	.010	5310-00-637-9541	WASHER, LOCK: COVER PLATE MTG MS35338-46 96906		EA	4	104
75	18	XBOZZ	XC	XBHZZ	XBFZZ	-	-		PLATE COVER 40-3070101B 28265		EA	2	2
75	19	PAOZZ	PAOZZ	PAGZZ	PAFZZ	-	.040	5330-00-971-5607	GASKET: COVER PLATE 266701A 28265		EA	1	3

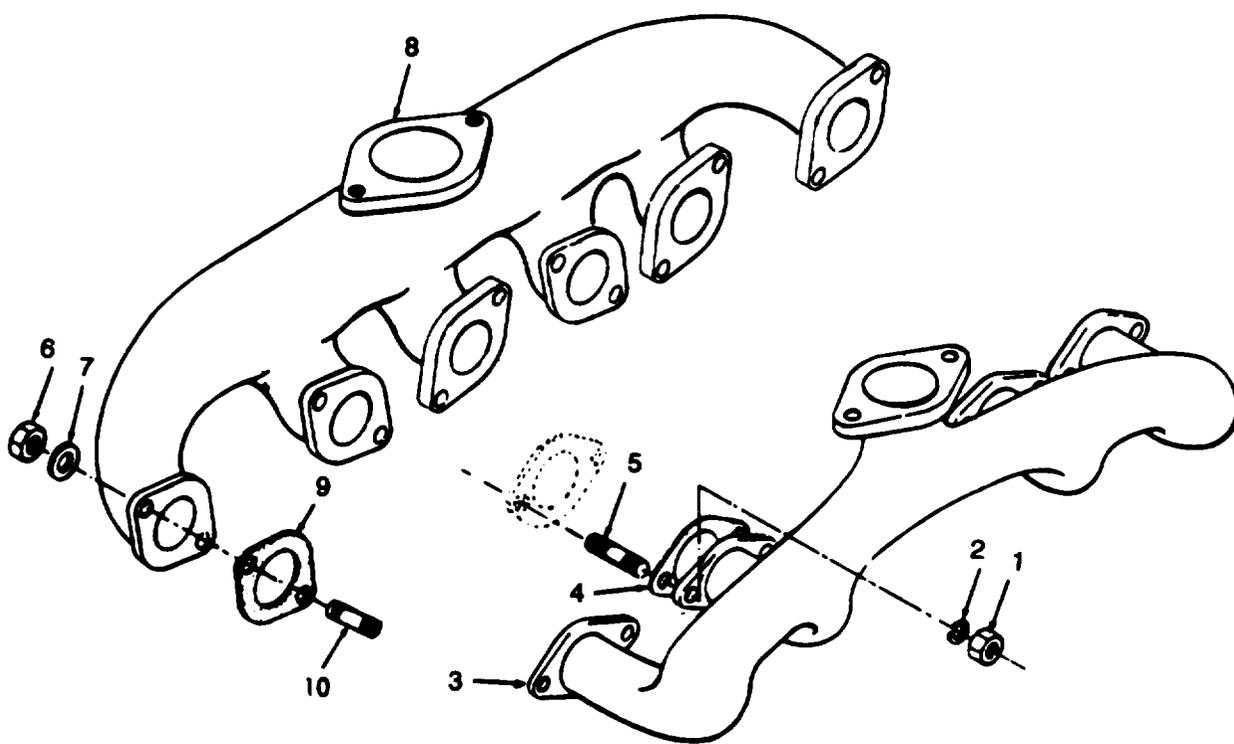

Figure 76. Intake and exhaust manifolds.

TM9-6115-465-24P
 TO35CZ-3-446-4
 NAVFAC P-8-625-24P
 SL-4-06858B/06859D

(1) ILLUSTRATION		(2) SMR CODE				(3)		(4) NATIONAL STOCK NUMBER	(5) DESCRIPTION	(6) USABLE ON CODE	(7) QTY INC IN UNITS	(8) USMC QTY PER EQUIP
A FIG. NO.	B ITEM NO.	A ARMY	B AIR FORCE	C NAVY	D USMC	A SSI	B REPL FACTOR	REF NUMBER & MFR CODE	U/M			
76	1	PAOZZ	PAOZZ	PAGZZ	PAFZZ	D	.008	5310-00-732-0559 NUT, PLAIN, HEXAGON MANIFOLD MTG MS51968-8 96906	EA	8	12	
76	2	PAOZZ	PAOZZ	PAGZZ	PAFZZ	D	.010	5310-00-637-9541 WASHER, LOCK; MANIFOLD MTG MS35338-46 96906	EA	8	104	
76	3	PAOZZ	PAOZZ	PBGZZ	PAFZZ	D	.007	2815-00-226-7940 MANIFOLD, INTAKE 290679D 28265	EA	1	1	
76	4	PAOZZ	PAOZZ	KFGZZ	PAFZZ		.040	5330-00-291-8972 GASKET: INTAKE MANIFOLD MTG (ALSO PART OF KIT, P/N 40-3094661A AND 40-3094662A) 87A 28265	EA	4	4	
76	5	PAOZZ	PAOZZ	XBGZZ	PAFZZ	D	.008	5307-00-916-6741 STUD, MANIFOLD 11662A2 28265	EA	8	8	
76	6	PAOZZ	PAOZZ	PAGZZ	PAFZZ	D	.008	5310-00-605-5259 NUT, PLAIN, HEXAGON: MANIFOLD MTG 201426A 28265	EA	12	12	
76	7	PAOZZ	PAOZZ	PAGZZ	PAFZZ	D	.010	5310-00-454-2739 WASHER, FLAT: MANIFOLD MTG 3305A 28265	EA	12	12	
76	8	XBOZZ	PBOZZ	PBGZZ	PAFZZ	D	.009	2815-00-945-1143 MANIFOLD, EXHAUST 2903300D 28265	EA	1	1	
76	9	PAOZZ	PAOZZ	PAGZZ	PAFZZ		.040	5330-00-171-7034 GASKET: EXHAUST MANIFOLD (ALSO PART OF KIT, P/N 40-3094661A AND 40- 3094662A) 76036A 28265	EA	6	6	
76	10	XBOZZ	PAOZZ	PAGZZ	PFZZ	D	.008	5307-00-605-8227 STUD, PLAIN: EXHAUST MANIFOLD 13114A 23265	EA	12	12	

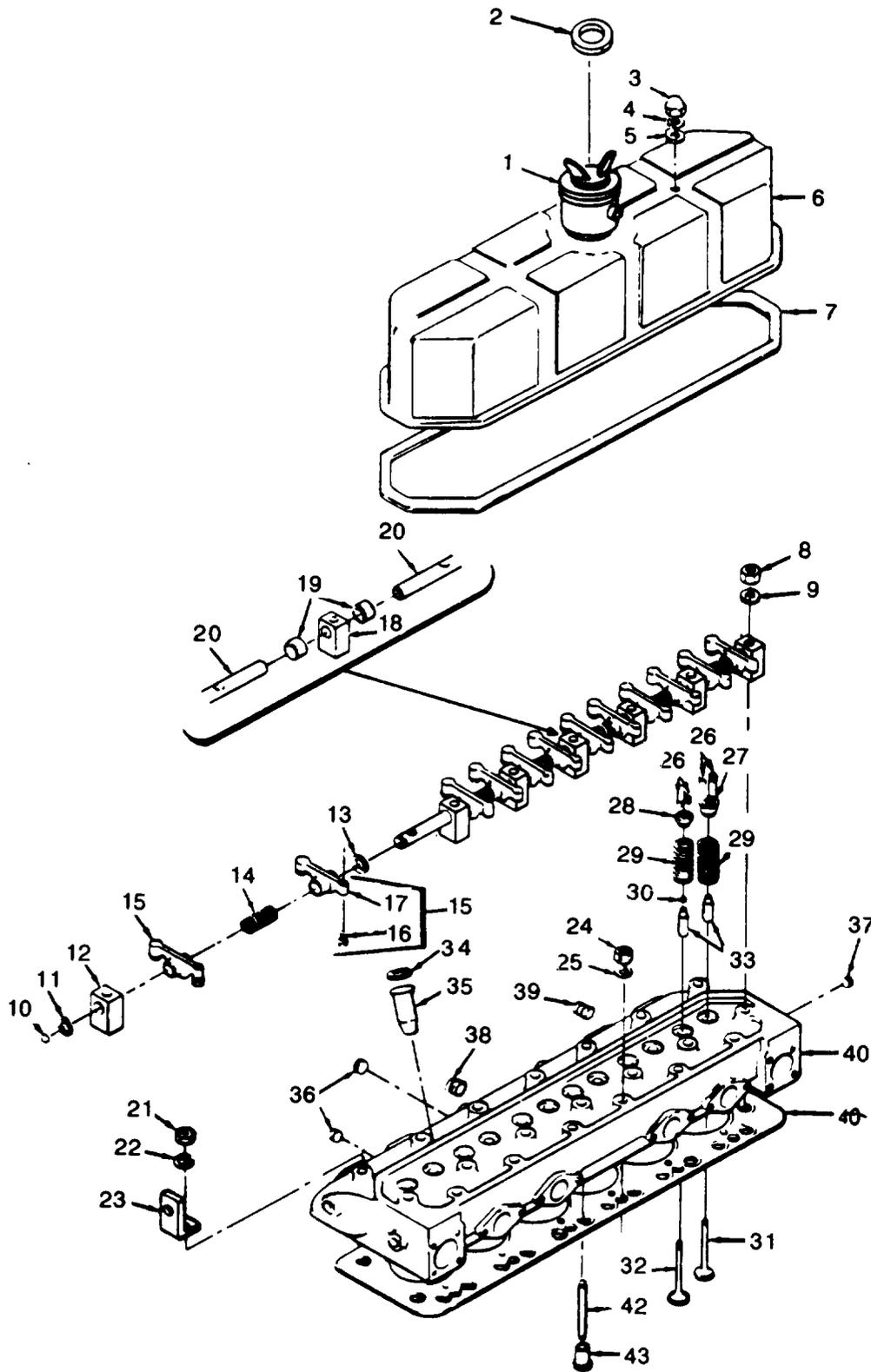

Figure 77. Cylinder head, cover, and valve operating mechanism.

TM 9-6115-465-24P
TO 35C2-3-446-4
NAVFAC P-8-625-24P
SL-4-06858B/06859D

(1) ILLUS- TRATION		(2) SMR CODE				(3)		(4)	(5) DESCRIPTION			(6)	(7)	(8)
a	b	a	b	c	d	a	b	NATIONAL STOCK NUMBER	REF NUMBER & MFR CODE	USABLE ON CODE	U/M	QTY INC IN UNIT	USMC QTY PER EQUIP	
FIG NO.	ITEM NO.	ARMY	AIR FORCE	NAVY	USMC	SSI	REPL FACTOR							
77	1	PAOZZ	PAOZZ	APOOO	PAOZZ	D	.010	2815-00-628-0386	BREATHER VALVE COVER 201941 00736		EA	1	1	
77	2	PAOZZ	PAOZZ	PAOZZ	PAOZZ	D	.008	5330-00-842-0382	GASKET: BREATHER (PART OF KIT P/N 40-309-4662) 20 4420A 28265					
77	3	PAOZZ	PAOZZ	XBGZZ	PAOZZ	D	.008	5310-00-628-3860	NUT: VALVE COVER MTG 40-001720A 28285		EA	3	3	
77	4	PAOZZ	PAOZZ	XBGZZ	PAOZZ	D	.008	5310-00-275-9421	WASHER, FLAT: VALVE COVER MTG 10566GT 31007		EA	3	3	
77	5	PAOZZ	PAOZZ	PAGZZ	PAOZZ	-	.040	5310-00-987-6365	WASHER: VALVE COVER STUD (PART OF KIT, P/N 403094661A AND 40-3094662A) 40-0001525 28265					
77	6	XBOZZ	PAOZZ	PAGZZ	PAOZZ	-	-	2815-00-085-5577	COVER, VALVE 285203E 28265		EA	1	1	
77	7	PAOZZ	PAOZZ	PAGZZ	PAOZZ	-	.040	5330-00-878-3823	GASKET: HEAD COVER (PART OF KIT P/N 40-3094661A AND 40-394622A) 285213 28265		EA	1	1	
77	8	PAFZZ	PAOZZ	PAGZZ	PAFZZ	D	.006	5310-00-276-2698	NUT, PLAIN, HEXAGON: HEAD MTG N110-1 78500		EA	7	14	
77	9	PAFZZ	PAOZZ	PAGZZ	PAFZZ	D	.010	5310-00-703-8214	WASHER, FLAT: HEAD MTG 10900409 19207		EA	14	14	
77	10	PAFZZ	PAOZZ	XBGZZ	PAFZZ	D	.005	5340-00-623-1725	PLUG, CUP 13132A 28265		EA	2	2	
77	11	PAFZZ	PAOZZ	XBGZZ	PAFZZ	D	.013	5365-00-191-3978	RING, SNAP: ROCKER SHAFT 203480A 28265		EA	2	2	
77	12	XBFZZ	XB	XBGZZ	XBFZZ	-	-		SUPPORT: ROCKER ARM SHAFT 40-3005202C 28265		EA	8		
77	13	XBFZZ	XB	XBGZZ	XBFZZ	-	-		SPACER: ROCKER ARM 40-003820A 28265		EA	22	22	
77	14	PAFZZ	PAOZZ	PAGZZ	PAFZZ	-	.015	5360-00-543-3760	SPRING ROCKER ARM 255080A 28265		EA	6	8	
77	15	PAFZZ	PAOZZ	PAGZZ	PAFZZ	D	.006	2815-00-961-1660	ROCKER ARM ASSEMBLY: VALVE 288077BS 28265		EA	12	12	
77	16	PAFZZ	PAOZZ	PAGZZ	PAFZZ	-	-	5305-00-630-4811	SCREW, ADJUSTING: ROCKER ARM 40-0017301B 28265		EA	12	12	
77	17	XAFZZ	XAGZZ	XAGZZ	XAFZZ	-	-		ARM, ROCKER 288075B 28265		EA	12	12	
77	18	PAFZZ	XB	XBGZZ	PAFZZ	D	.008	2805-01-025-7901	SUPPORT: ROCKER SHAFT 40-3005201A 28265		EA	7	7	
77	19	XBFZZ	XB	XBGZZ	XBFZZ	-	-		SPACER: ROCKER ARM 40-0003821A 28265		EA	2	2	
77	20	PAFZZ	PAOZZ	XBGZZ	PAFZZ	D	.050	2815-00-614-6484	SHAFT, ROCKER ARM 40-3005101 28265		EA	2	2	
77	21	PAOZZ	XB	XBGZZ	PAOZZ	D	.008	5310-01-014-6163	NUT, PLAIN, HEXAGON: LIFTING EYE 4304A 28265		EA	2	2	
77	22	PAOZZ	PAOZZ	PAGZZ	PAOZZ	D	.010	5310-01-054-8415	WASHER, LOCK 1126A 28265		EA	2		

(1) ILLUSTRATION		(2) SMR CODE				(3)		(4)	(5)	(6)	(7)	(8)
A	B	A	B	C	D	A	B	NATIONAL STOCK NUMBER	DESCRIPTION	USABLE ON CODE	QTY INC IN UNITS	USMC QTY PER EQUIP
FIG. NO.	ITEM NO.	ARMY	AIR FORCE	NAVY	USMC	SSI	REPL FACTOR		REF NUMBER & MFR CODE	U/M		
77	23	XBOZZ	XB	XBGZZ	PAOZZ			2805-00-044-0617	EYE, LIFTING 206425A 28265	EA	2	2
77	24	PAFZZ	PAOFF	PAGZZ	PAFZZ	D	.008	5310-00-262-5142	NUT, PLAIN, HEXAGON: CYLINDER HEAD MTG 14728A 28265	EA	14	
77	25	PAFZZ	POAZZ	PAGZZ	PAFZZ	D	.010	5310-00-703-8213	WASHER, FLAT: HEAD MTG 203077A 28265	EA	6	6
77		PAFFF	PAOZZ	PDGGG	PAFFF		.800	2815-00-460-3268	HEAD ASSEMBLY, CYLINDER 293205-AS 28265	EA	1	1
77	26	PAFZZ	PAOZZ	PAHZZ	PAFZZ		.027	2815-00-270-3435	LOCK, SEAT: VALVE 77019A 28265	EA	24	24
77	27	PAFZZ	PAOZZ	PAGZZ	PAFZZ		.006	2805-00-905-5861	ROTCOIL: VALVE 287012A 28265	EA	6	6
77	28	PAFZZ	PAOZZ	PBGZZ	PAFZZ		.077	2815-00-972-7178	SEAT, VALVE SPRING 255023A 28665	EA	6	6
77	29	PAFZZ	PAOZZ	PAGZZ	PAFZZ		.015	2815-00-871-6756	SPRING, VALVE 288021A 28265	EA	12	12
77	30	PAFZZ	PAOZZ	PAGZZ	PAFZZ		.013	2815-00-961-4573	SEAL, STEM: VALVE (PART OF KIT, P/N 40-3094661A AND 40-3094662-A) 288020A 28265	EA	6	6
77	31	PAFZZ	PAOZZ	PAGZZ	PAFZZ		.027	2815-00-928-8867	VALVE, EXHAUST 293011B 28265	EA	6	6
77	32	PAFZZ	PAOZZ	PAHHH	PAFZZ		.027	2815-00-903-3566	VALVE, INTAKE 291010B 28265	EA	6	6
77	33	PAFZZ	PAOZZ	PBGZZ	PAFZZ		.027	2815-00-961-1674	GUIDE, VALVE 256019B 28265	EA	12	12
77	34	PAFZZ	PAOZZ	PAGZZ	PAFZZ		.050	5310-00-167-9009	WASHER: INJECTOR SLEEVE 206752A 28265	EA	6	6
77	35	XBFZZ	PAOZZ	PAGZZ	PAFZZ			2815-00-961-1675	SLEEVE: INJECTOR 293517A 28265	EA	6	6
77	36	PAOZZ	PAOZZ	PAGZZ	PAFZZ	D	.005	4730-00-801-8186	PLUG, PIPE: HED S-915-A 15434	EA	3	3
77	37	XBOZZ	XB	XBGZZ	XBFZZ				PLUG, PIPE: HEAD 444783 19206	EA	1	1
77	38	XBOZZ	XB	XBGZZ	XBFZZ				PLUG, PIPE: HEAD 7086700 19207	EA	1	1
77	39	XBOZZ	PAOZZ	XBGZZ	XBFZZ				PLUG, PIPE: HEAD P112 78500	EA	1	1
77	40	XAOFZ	PAOZZ	XAGZZ	PAFZZ			2815-00-922-0179	HEAD, CYLINDER 293200E 28265	EA	1	1
77	41	PAOZZ	PAOZZ	PAHZZ	PAFZZ		.040	5330-00-133-0811	GASKET: HEAD (PART OF KIT, P/N 40-3094661A AND 40-3094662A) 287218 28265	EA	1	1
77	42	PAOZZ	PAOZZ	PAGZZ	PAFZZ		.007	2815-00-678-6083	ROD, PUSH: VALVE 255013 28265	EA	12	12
77	43	PAOZZ	PAOZZ	PAFZZ	PAFZZ		.027	2815-00-678-6082	TAPPET, VALVE 255012A 28265	EA	12	12

(1) ILLUSTRATION A FIG. NO.	(2) SMR CODE B ITEM NO.	(3)				(4) NATIONAL STOCK NUMBER	(5) DESCRIPTION REF NUMBER & MFR CODE	(6) USABLE ON CODE U/M	(7) QTY INC IN UNITS	(8) USMC QTY PER EQUIP		
		A ARMY	B AIR FORCE	C NAVY	D USMC SSI							
78	1	PAOZZ	PAOZZ	PAOZZ	PAOZZ	D	.010	6680-00-198-7058	DIP STICK: OIL LEVEL 260269B 28265	EA	1	1
78	2	PAFZZ	PAOZZ	PAGZZ	PAFZZ	D	.008	5305-00-269-3209	SCREW, CAP, HEXAGON 4585A 28265	EA	28	30
78	3	PAFZZ	PAOZZ	PAGZZ	PAHZZ	D	.010	5310-00-637-9541	WASHER, LOCK: OIL PAN MTG MS35338-46 96906	EA	28	104
78	4	XBFZZ	PAOZZ	PBGZZ	PAFZZ			2815-00-614-6559	PAN ASSEMBLY, OIL 40-3019151D 28265	EA	1	1
78	5	PAFZZ	PAOZZ	KFGZZ	PAFZZ		.040	5330-01-055-4548	GASKET: OIL PAN MTG (PART OF KIT, P/N 40-3094662A) 291984 28265	EA	2	2
78	6	PAFZZ	PAOZZ	XFGZZ	PAFZZ		.030	5330-00-649-8437	SEAL, OIL: OIL PAN (PART OF KIT, P/N 40-394662A) 255185A 28265	EA	2	2
78	7	PAFZZ	PAOZZ	PAGZZ	PAFZZ	D	.008	5310-00-268-6093	NUT, PLAIN, HEXAGON: ADAPTER MTG 28A 28265	EA	6	6
78	8	PAFZZ	PAOZZ	PAGZZ	PAFZZ	D	.010	5310-00-010-3320	WASHER, LOCK: ADAPTER MTG 615A 28265	EA	4	
78	9	XBFZZ	PAOZZ	PAGZZ	PAFZZ			2815-00-012-2280	ADAPTER, OIL PAN 255179B 28265	EA	2	2
78	10	PAFZZ	PAOZZ	PAGZZ	PAFZZ	D	.008	2815-00-718-4830	STRAINER, OIL PUMP 285196B 28265	EA	1	1
78	11	PAFZZ	PAOZZ	PAGZZ	PAFZZ	D	.008	5305-00-269-3211	SCREW, CAP, HEXAGON HEAD: PUMP MTG MS90725-60 96906	EA	2	5
78	12	PAFZZ	PAOZZ	PAGZZ	PAFZZ	D	.010	5310-00-637-9541	WASHER, LOCK: OIL PUMP MTG MS35338-46 96906	EA	2	104
78		PAFHH	PAOZZ	PAGGG	PAFHH		.800	4320-00-309-0343	PUMP ASSEMBLY, OIL 40-3025151 28265	EA	1	1
78	13	PAHZZ	PAOZZ	PAGZZ	PAHZZ	D	.008	5306-00-916-6609	BOLT, MACHINE: COVER MTG 202536A 28265	EA	6	6
78	14	PAHZZ	PAOZZ	XBGZZ	PAHZZ	D	.008	5306-00-618-0710	SCREW, CAP, HEXAGON HEAD: COVER MTG 14875A 28265	EA	2	2
78	15	PAHZZ	PAOZZ	PAGZZ	PAHZZ	D	.010	5310-00-637-3027	WASHER, LOCK: COVER MTG 0A18036F15 06840	EA	2	2
78	16	XBHZZ	XAOZZ	XBGZZ	XBHZZ				COVER, OIL PUMP 285184B 28265	EA	1	1
78	17	PAHZZ	PAOZZ	XBGZZ	PAHZZ		.050	3020-00-938-5768	GEAR, DRIVE 282263C 28265	EA	1	1
78	18	XAHZZ	PAOZZ	XAGZZ	PAHZZ			2910-00-420-4802	PUMP ASSEMBLY, OIL 287311DS 28265	EA	1	1
78	19	XDHZZ	PAOZZ	XBFZZ	PAHZZ		.050	3020-01-203-9895	GEAR, IDLER 287314A 28265	EA	1	1
78	20	PAHZZ	PAOZZ	XBGZZ	PAHZZ		.050	3020-01-025-6532	GEAR, DRIVE SHAFT 285194A 28265	EA	1	1
78	21	PAFZZ	PAOZZ	XBFZZ	PAHZZ		.050	3040-01-011-6347	SHAFT, DRIVE 286269B 28265	EA	1	1

TM9-6115-465-24P
 TO35CZ-3-446-4
 NAVFAC P-8-625-24P
 SL-4-06858B/06859D

(1) ILLUSTRATION A	(2) SMR CODE A	B	C	D	(3) A	B	(4) NATIONAL STOCK NUMBER	(5) DESCRIPTION REF NUMBER & MFR CODE	USABLE ON CODE	(6) U/M	(7) QTY INC IN UNITS	(8) USMC QTY PER EQUIP	
													B
78	22	XBHZZ	XAOZZ	XBGZZ	XBHZZ			BODY SHAFT ASSEMBLY 287315AS 28265		EA	1	1	
78	23	PAHZZ	PAOZZ	XAGZZ	PAHZZ	.050	3040-01-025-4146	SHAFT 287313A 28265		EA	1	1	
78	24	XBHZZ	XAOZZ	XAGZZ	XBHZZ			BODY 286303D 28265		EA	1	1	
78		PAHZZ	PAOZZ	XBGZZ	PAHZZ	.010	4320-00-622-5790	REGULATOR ASSEMBLY 40-3092356B 28265		EA	1	1	
78	25	PAHZZ	PAOZZ	XBGZZ	PAHZZ	D	.008	5315-00-400-5575	PIN, SPRING 6161738 28265		EA	1	1
78	26	PAHZZ	PAOZZ	XBGZZ	PAHZ	D	.008	5340-01-025-6547	RETAINER 40-3092305A 28265		EA	1	1
78	27	PAHZZ	PAOZZ	PAGZZ	PAHZZ		.015	5360-01-025-4653	SPRING, BODY 40-3092304 28265		EA	1	1
78	28	PAHZZ	PAOZZ	PAGZZ	PAHZZ	D	.008	4820-01-025-9725	PISTON 40-3092309A 28265		EA	1	1
78	29	XAHZZ	XAOZZ	XBGZZ	XAHZZ			BODY SLEEVE 40-3092354B 28265		EA	1	1	
78	30	PAHZZ	PAOZZ	PAGZZ	PAHZZ	D	.010	5310-00-917-0963	WASHER, LOCK: REGULATOR BODY MTG 285271A 28265		EA	1	1
78	31	PAHZZ	PAOZZ	PAGZZ	PAHZZ			5365-00-929-1745	SHIM: REGULATOR BODY MTG 205354A 28265		EA	V	V

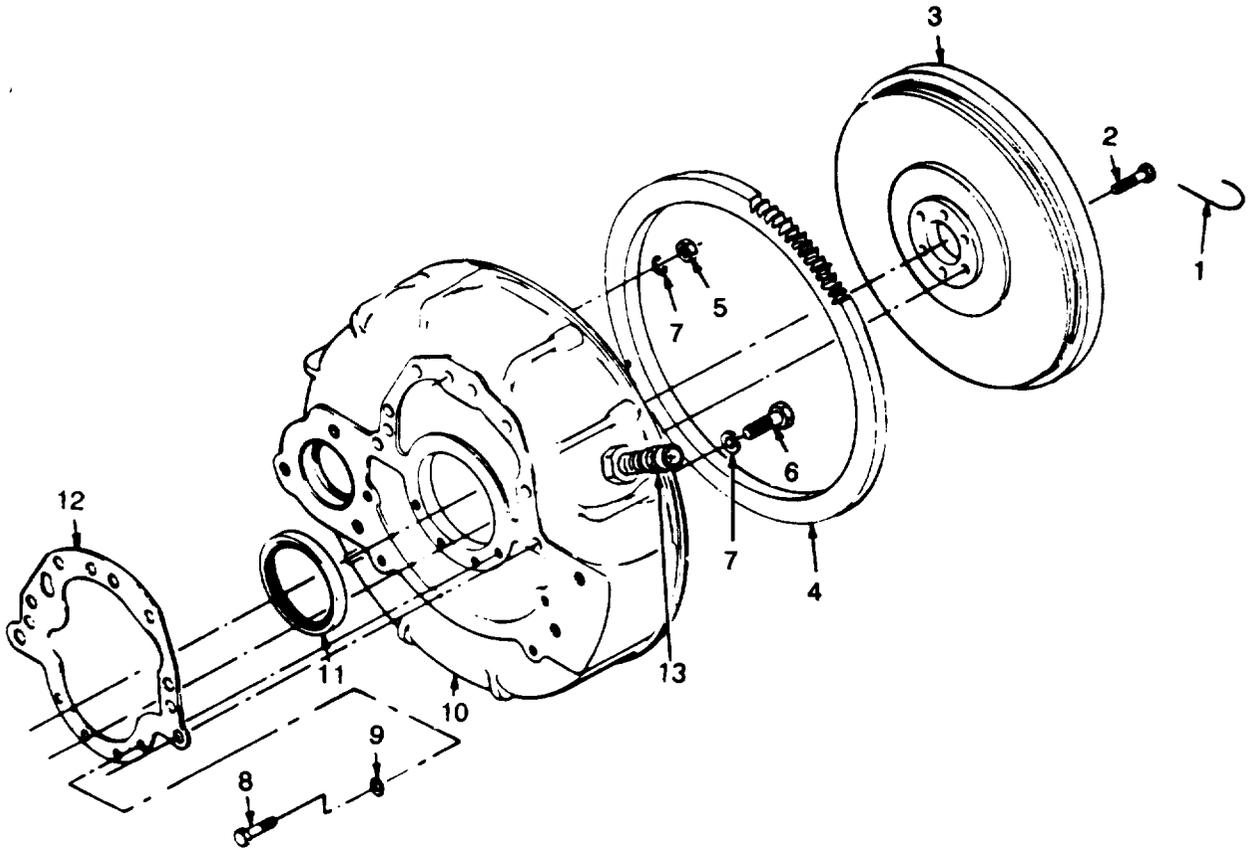

Figure 79. Flywheel, ring gear and housing.

(1) ILLUSTRATION		(2) SMR CODE				(3)		(4) NATIONAL STOCK NUMBER	(5) DESCRIPTION	(6) USABLE ON CODE	(7) QTY INC IN UNITS	(8) USMC QTY PER EQUIP
A FIG. NO.	B ITEM NO.	A ARMY	B AIR FORCE	C NAVY	D USMC	A SSI	B REPL FACTOR	REF NUMBER & MFR CODE	U/M			
79	1	PAFZZ	PAOZZ	MGZGZ	PAHZZ	D	.013	2805-00-567-8003 WIRE, LOCK FLYWHEEL BOLT 267A 28265	EA	2	2	
79	2	PAFZZ	PAOZZ	XBGZZ	PAHZZ	D	.008	5306-00-616-5650 BOLT, MACHINE FLYWHEEL MTG 40-001314A 28265	EA	6	6	
79	3	XBFZZ	XC	PBHZZ				FLYWHEEL, ENGINE 40-3045301C 28265	EA	1	1	
79	4	PAFZZ	PAOZZ	PAHZZ	PAHZZ	D	.050	3020-00-938-5766 GEAR, RING FLYWHEEL 206802-A 28265	EA	1	1	
79	5	PAFZZ	PAOZZ	PAGZZ	PAHZZ	D	.008	5310-00-596-5086 NUT, PLAIN, HEXAGON HOUSING MTG MS18154-113 96906	EA	4	5	
79	6	PAFZZ	PAOZZ	PAGZZ	PAHZZ	D	.008	5305-00-915-8087 SCREW, CAP, HEXAGON HEAD MS90725-111 96906	EA	6	6	
79	7	PAFZZ	PAOZZ	PAGZZ	PAHZZ	D	.010	5310-00-584-5272 WASHER, LOCK MS35338-48 96906	EA	8	41	
79	8	PAHZZ	PAOZZ	PAGZZ	PAHZZ	D	.008	5305-01-014-4251 SCREW, CAP, HEXAGON HEAD 1865A 28265	EA	4	5	
79	9	PAFZZ	PAOZZ	PAGZZ	PAHZZ	D	.010	5310-00-061-1258 WASHER LOCK HOUSING MTG MS45904-76 96906	EA	8	8	
79	10	XBFZZ	XC	XBHZZ	XBHZZ			BELL HOUSING, FLYWHEEL 40-3040801D 28265	EA	1	1	
79	11	KFFZZ	PAOZZ	KFGZZ	KFHZZ			5330-01-028-7654 SEAL, OIL (PART OF KIT, P/N 40-3094662A) 40-0003205 28265	EA	1	1	
79	12	KFFZZ	PAOZZ	PAGZZ	KFHZZ			5330-00-893-7799 GASKET, HOUSING MTG (PART OF KIT, P/N 40-3094662A) 291035D 28265	EA	1	2	
79	13	PAFZZ	PAOZZ					2910-01-134-4520 MAGNETIC PICKUP 81-4904 30554	CLC EA	1		

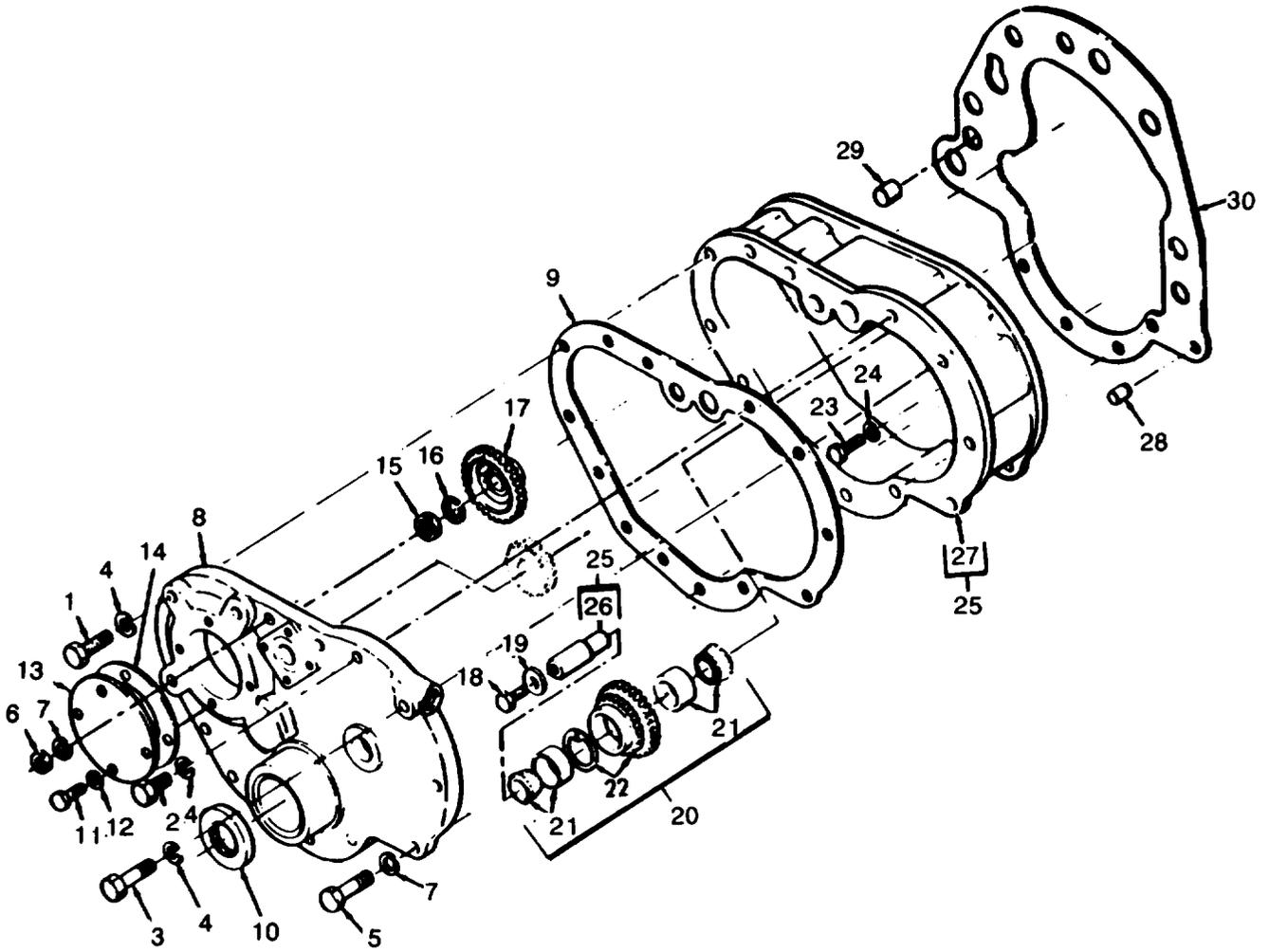

Figure 80. Gear case and timing gears.

(1) ILLUSTRATION		(2) SMR CODE				(3)		(4)	(5)	(6)	(7)	(8)
A	B	A	B	C	D	A	B	NATIONAL STOCK NUMBER	DESCRIPTION	USABLE ON CODE	QTY INC IN UNITS	USMC QTY PER EQUIP
FIG. NO.	ITEM NO.	ARMY	AIR FORCE	NAVY	USMC	SSI	REPL FACTOR		REF NUMBER & MFR CODE	U/M		
80	1	PAHZZ	PAOZZ	PAGZZ	PAHZZ	D	.008	5305-00-269-3211	SCREW, CAP, HEXAGON HEAD: COVER MTG MS90725-60 96906	EA	3	5
80	2	PAHZZ	PAOZZ	PAGZZ	PAHZZ	D	.008	5305-00-616-5649	SCREW, CAP, HEXAGON HEAD: COVER MTG 315A 28265	EA	8	20
80	3	PAHZZ	PAOZZ	PAGZZ	PAHZZ	D	.008	5305-01-014-4251	SCREW, CAP, HEXAGON HEAD: COVER MTG 1865A 28265	EA	8	20
80	4	PAHZZ	PAOZZ	PAGZZ	PAHZZ	D	.010	5310-00-637-9541	WASHER, LOCK: COVER MTG MS35338-46 96906	EA	12	104
80	5	PAHZZ	PAOZZ	PAGZZ	PAHZZ	D	.08	5305-00-033-7507	BOLT, MACHINE: COVER MTG 8552A 28265	EA	1	1
80	6	PAHZZ	PAOZZ	PAGZZ	PAHZZ	D	.008	5310-00-596-5086	NUT, PLAIN, HEXAGON: COVER MTG 201565 28265	EA	1	5
80	7	PAHZZ	PAOZZ	PAGZZ	PAHZZ	D	.010	5310-00-584-5272	WASHER, LOCK: COVER MTG MS35338-48 96906	EA	3	41
80	8	XBHZZ	XA	XBGZZ	XBHZZ				COVER, HOUSING 40-3015801D 28265	EA	1	1
80	9	KFHZZ	PAOZZ	PAGZZ	KFHZZ			5330-00-790-2659	GASKET: GEAR COVER (PART OF KIT, P/N 40-304662A) 260046D 28265	EA	1	1
80	10	PAFZZ	PAOZZ	PAGZZ	KFHZZ			5330-00-598-8962	SEAL, COVER (PART OF KIT, P/N 40-3094662A) 40-0003216A 28265	EA	1	1
80	11	PAHZZ	PAOZZ	PAGZZ	PAHZZ	D	.008	5305-00-616-5649	SCREW, CAP, HEXAGON HEAD: COVER MTG 315A 28265	EA	4	20
80	12	PAHZZ	PAOZZ	PAGZZ	PAHZZ	D	.040	5330-00-530-2523	GASKET: COVER SCREW (PART OF KIT, P/N 40-3094662A) 76109A 28265	EA	4	4
80	13	XBHZZ	PAOZZ	XBGZZ	PAHZZ			5305-01-014-4251	PLATE, GEAR COVER 260047B 28265	EA	1	1
80	14	PAHZZ	PAOZZ	PAGZZ	PAHZZ		.040	5330-00-231-0283	GASKET: PLATE 76189A 28265	EA	1	1
80	15	PAHZZ	PAOZZ	PAGZZ	PAHZZ	D	.008	5310-01-040-7974	NUT, PLAIN, HEXAGON: GEAR MTG 2411A 28265	EA	1	1
80	16	PAHZZ	PAOZZ	PAGZZ	PAHZZ	D	.010	5310-00-637-9541	WASHER, LOCK: GEAR TO PUMP MS35338-46 96906	EA	1	104
80	17	PAHZZ	PAOZZ	PAGZZ	PAHZZ		.050	3020-01-100-7976	GEAR, FUEL PUMP 40-3076501-D 28265	EA	1	1
80	18	PAHZZ	PAOZZ	XBHZZ	PAHZZ	D	.008	5305-00-225-8503	SCREW, CAP, HEXAGON HEAD: IDLER GEAR MS90725-39 96906	EA	2	1
80	19	PAHZZ	PAOZZ	XBGZZ	PAHZZ	D	.010	5310-00-628-3874	WASHER, FLAT: IDLER GEAR 40-0001517A 28265	EA	1	1
80	20	XBHZZ	PAOZZ	AGGGG	PAHZZ			3020-01-118-1072	GEAR, BEARING ASSEMBLY 40-3076051 28265	EA	1	1
80	21	PAHZZ	PAOZZ	PAGZZ	PAHZZ		.024	3110-00-596-3415	BEARING, IDLER GEAR 40-0012306B 27255	EA	2	2
80	22	PAHZZ	PAOZZ	PBGZZ	PAHZZ		.050	3020-01-025-4952	GEAR, IDLER 40-2076001 28265	EA	1	1

TM9-6115-465-24P
 TO35CZ-3-446-4
 NAVFAC P-8-625-24P
 SL-4-06858B/06859D

(1) ILLUSTRATION		(2) SMR CODE				(3)		(4) NATIONAL STOCK NUMBER	(5) DESCRIPTION	(6) USABLE ON CODE	(7) QTY INC IN UNITS	(8) USMC QTY PER EQUIP
A FIG. NO.	B ITEM NO.	A ARMY	B AIR FORCE	C NAVY	D USMC	A SSI	B REPL FACTOR	REF NUMBER & MFR CODE	U/M			
80	23	PAHZZ	PAOZZ	PAGZZ	PAHZZ	D	.008	5306-00-207-3510	SCREW, CAP, HEXAGON HEAD: HOUSING MTG 14512A 28265	EA	5 5	
80	24	PAHZZ	PAOZZ	PAGZZ	PAHZZ	D	.010	5310-00-249-2279	WASHER, LOCK: HOUSING MTG 50035613 11757	EA	5 5	
80	25	XBHZZ	PAOZZ	XBGZZ	PAHZZ			2815-00-614-6553	HOUSING, SHAFT ASSEMBLY 40-3015152D 28265	EA	1 1	
80	26	XBHZZ	XA	XBGZZ	XBHZZ				SHAFT, IDLER 40-3095702B 28265	EA	1 1	
80	27	XBHZZ	XA	XAGZZ	XBHZZ				HOUSING, GEAR 40-3015101D 28265	EA	1 1	
80	28	XBHZZ	PAOZZ	XBGZZ	PAHZZ			3120-00-492-9096	DOWEL, PIN: COVER 3673A 28265	EA	1 1	
80	29	XBHZZ	PAOZZ	XBGZZ	PAHZZ			2930-00-215-4065	DOWEL, COVER 2210A 28265	EA	1 1	
80	30	PAHZZ	PAOZZ	KFGZZ	PAHZZ			5330-00-893-7799	GASKET: HOUSING, GEAR 291035D 28265	EA	1 1	

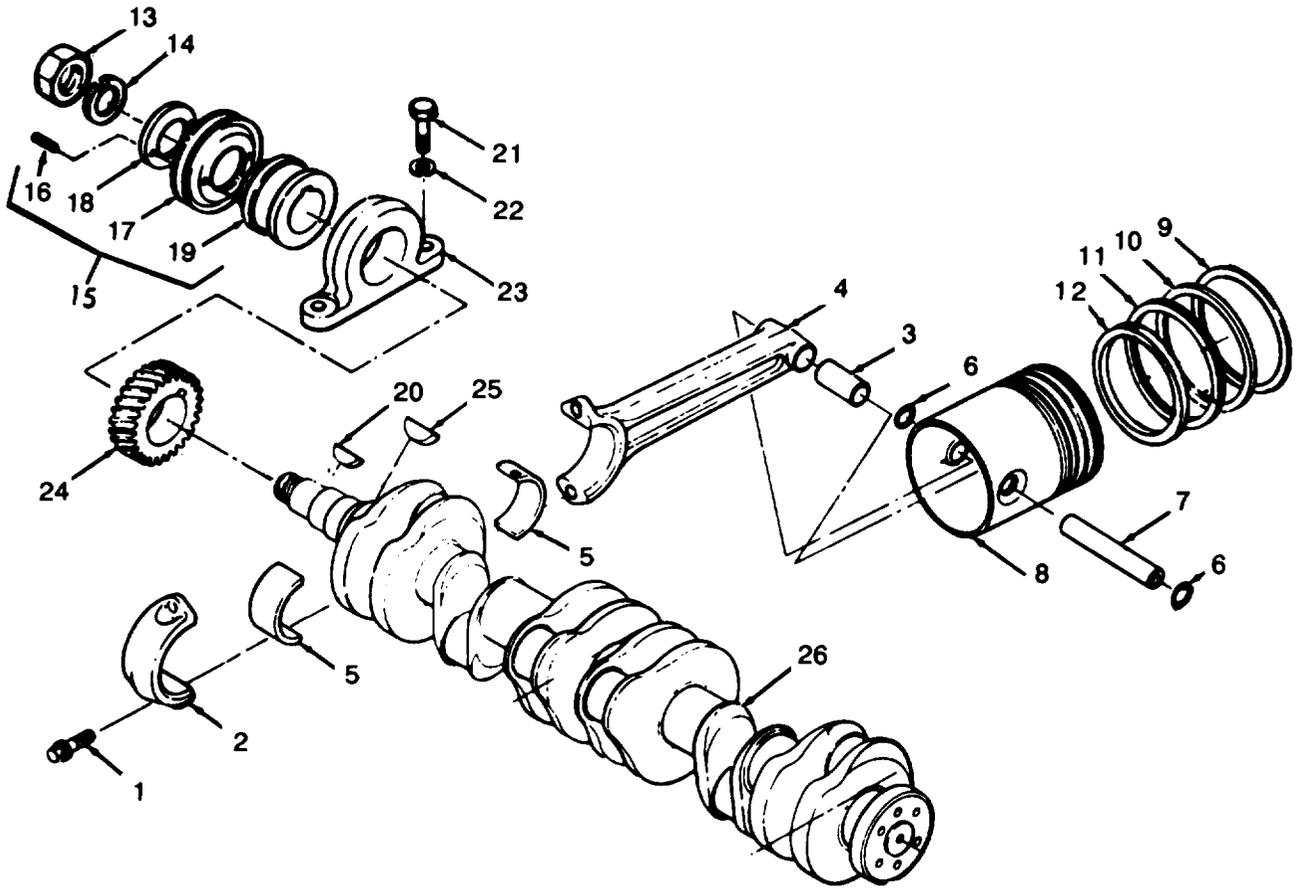

Figure 81. Piston, connecting rod, crankshaft and support.

(1) ILLUSTRATION A FIG. NO.	(2) SMR CODE A B AIR FORCE	C	D	(3) A SSI	B REPL FACTOR	(4) NATIONAL STOCK NUMBER	(5) DESCRIPTION REF NUMBER & MFR CODE	(6) USABLE ON CODE U/M	(7) QTY INC IN UNITS	(8) USMC QTY PER EQUIP		
											ARMY	NAVY
81	PAHZZ	PAOZZ	AGGDD	PAHZZ	.027	2815-00-931-6782	ROD, BEARING ASSEMBLY 288290AS 28265	EA	6	6		
81	XAHZZ	PAOZZ	PDGDD	PAHZZ		2815-00-938-5811	ROD ASSEMBLY, CONNECTING 288291AS 28265	EA	6	6		
81	1	PAHZZ	PAOZZ	XBGZZ	PAHZZ	D	.008	5306-00-616-5648	BOLT, SPECIAL: ROD CAP 40-3093301A 28265	EA	12	12
81	2	XAHZZ	XA	XAGZZ	XAHZZ			CAP, CONNECTING ROD 288198B 28265	EA	6	6	
81	3	PAHZZ	PAOZZ	PAGZZ	PAHZZ		.050	3120-00-917-1858	BUSHING, SLEEVE PISTON PIN 288199A 28265	EA	6	6
81	4	XAHZZ	XA	XAGZZ	XAHZZ			ROD, CONNECTING 288197D 28265	EA	6	6	
81	5	PAHZZ	PAOZZ	PAGZZ	PAHZZ		.050	3120-00-909-6148	BEARING, CONNECTING ROD 288095AS 28265	EA	12	12
81		PAHZZ	PAOZZ	PDGZZ	PAHZZ		.010	2815-00-904-7478	PISTON ASSEMBLY, ENGINE 291160AS 28265	EA	6	6
81	6	PAHZZ	PAOZZ	PDGZZ	PAHZZ		.013	2815-00-230-3493	RING, RETAINING: PIN 40-000706A 28265	EA	12	12
81	7	PAHZZ	PAOZZ	PDGZZ	PAHZZ		.010	2815-00-898-4887	PIN, PISTON 286116A 28265	EA	6	6
81	8	XAHZZ	XA	XAGZZ	XAHZZ			PISTON 291159A 28265	EA	6	6	
81	9	KFHZZ	PAOZZ	KFGZZ	KFHZZ			2805-00-277-2943	RING, PISTON (PART OF SET, NSN 2815-00-133-0816) 77112A 28265	EA	6	6
81	10	KFHZZ	PAOZZ	KFGZZ	KFHZZ			2815-00-898-4891	RING, PISTON (PART OF SET, NSN 2815-00-133-0816) 291161B 28265	EA	6	6
81	11	KFHZZ	PAOZZ	KFGZZ	KFHZZ			2815-00-898-4890	RING, PISTON (PART OF SET, NSN 2815-00-133-0816) 291162B 28265	EA	6	6
81	12	KFHZZ	PAOZZ	KFGZZ	KFHZZ			2815-00-898-4889	RING, PISTON (PART OF SET, NSN 2815-00-133-0816) 291163B 28265	EA	6	6
81	13	PAHZZ	PAOZZ	PAGZZ	PAHZZ	D	.008	5310-00-420-6046	NUT, PLAIN, HEXAGON CRANKSHAFT 2025658A 28265	EA	1	1
81	14	PAHZZ	PAOZZ	PAGZZ	PAHZZ	D	.010	5310-00-400-3495	WASHER, LOCK: CRANKSHAFT, NUT 1569A 28265	EA	1	1
81	15	PAHZZ	PAOZZ	PAHZZ	PAHZZ	D	.005	2815-00-938-8046	PULLEY, ASSEMBLY: CRANKSHAFT 287270BS 28265	EA	1	1
81	16	XAHZZ	PAOZZ	XBHZZ	PAHZZ	D	.008	5315-00-844-3662	PIN, ROLL MS16562-62 96906	EA	2	2
81	17	XAHZZ	XA	XAHZZ	XAHZZ				PULLEY, CRANKSHAFT 287267B 28265	EA	1	1
81	18	XAHZZ	PAOZZ	XBHZZ	PAHZZ			5365-01-015-6800	WASHER, PULLEY 287269A 28265	EA	1	1

TM9-6115-465-24P
 TO35CZ-3-446-4
 NAVFAC P-8-625-24P
 SL-4-06858B/06859D

(1) ILLUSTRATION		(2) SMR CODE				(3)		(4) NATIONAL STOCK NUMBER	(5) DESCRIPTION	(6) USABLE ON CODE	(7) QTY INC IN UNITS	(8) USMC QTY PER EQUIP
A FIG. NO.	B ITEM NO.	A ARMY	B AIR FORCE	C NAVY	D USMC	A SSI	B REPL FACTOR	REF NUMBER & MFR CODE	U/M			
81	19	XAHZZ	XAO	XAHZZ	XAHZZ			HUB, PULLEY 287268A 28265	EA	1	1	
81	20	PAHZZ	PAOZZ	PAGZZ	PAHZZ	D	.020	5315-00-012-4553 KEY, WOODRUFF: CRANKSHAFT HUB MS35756-17 96906	EA	1	1	
81	21	PAHZZ	PAOZZ	PAHZZ	PAHZZ	D	.008	5305-00-724-5913 SCREW, CAP, HEXAGON MS90725-166 96906	EA	2	2	
81	22	PAHZZ	PAOZZ	PAHZZ	PAHZZ	D	.010	5310-00-820-6653 WASHER, LOCK: TRUNNION MTG MS35338-50 96906	EA	2	2	
81	23	XBHZZ	PBOZZ	XBHZZ	PAHZZ			2815-00-614-6561 TRUNNION, CRANKSHAFT 40-30971016 28265	EA	1	1	
81		PBHZZ	PAOZZ	PBGZZ	PAHZZ	D	.008	2815-00-133-4828 CRANKSHAFT ASSEMBLY 40-3003058 28265	EA	1	1	
81	24	PAHZZ	PAOZZ	PBGZZ	PAHZZ	D	.008	3020-00-678-6094 GEAR, CRANKSHAFT 40-3076401-D 28265	EA	1	1	
81	25	PAHZZ	PAOZZ	PAGZZ	PAHZZ	D	.020	5315-00-021-8211 KEY, WOODRUFF: CRANKSHAFT GEAR MS35756-35 96906	EA	1	1	
81	26	XAHZZ	PAOZZ	XAGZZ	PAHZZ			2815-00-133-4828 CRANKSHAFT, ENGINE 288026AS 28265	EA	1	1	

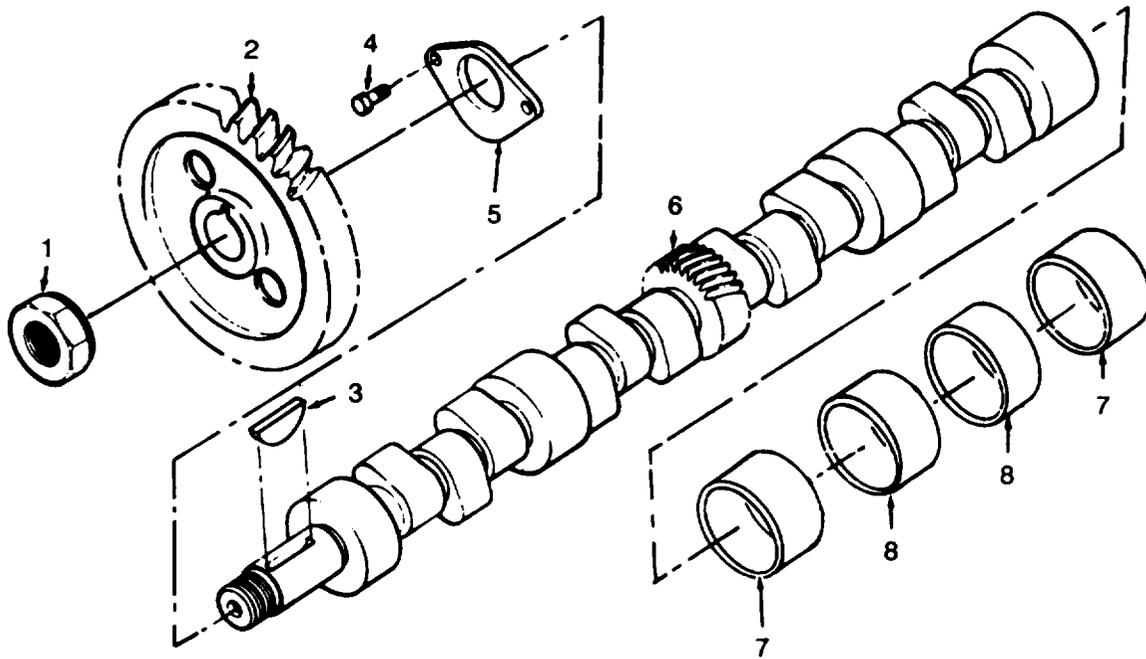

Figure 82. Camshaft, timing gear and bearings.

(1) ILLUSTRATION A	(2) SMR CODE A	B	C	D	(3) A	B	(4) NATIONAL STOCK NUMBER	(5) DESCRIPTION REF NUMBER & MFR CODE	USABLE ON CODE	(6) U/M	(7) QTY INC IN UNITS	(8) USMC QTY PER EQUIP
82	1	PAHZZ	PAOZZ	PAGZZ	PAHZZ	D	.008	5310-00-672-8890	NUT, PLAIN, HEXAGON: CAMSHAFT GEAR 255510A 28265	EA	1	1
82	2	PAHZZ	PAOZZ	PBGZZ	PAHZZ		.050	3020-01-041-0211	GEAR, CAMSHAFT 40-3076101-C 28265	EA	1	1
82	3	PAHZZ	PAOZZ	PAGZZ	PAHZZ	D	.020	5315-00-021-8211	KEY, GEAR MS35756-35 96906	EA	1	2
82	4	PAHZZ	PAOZZ	PAGZZ	PAHZZ	D	.008	5306-00-786-4021	BOLT, WASHER: LATCH PLATE 201991A 28265	EA	2	2
82	5	XBHZZ	PAOZZ	PAGZZ	PAHZZ			5306-00-961-1158	PLATE, LATCH: CAMSHAFT 255072A 28265	EA	1	1
82	6	PAHZZ	PAOZZ	PAGZZ	PAHZZ		.015	2815-00-133-0815	CAMSHAFT, ENGINE 287060 28265	EA	1	1
82	7	PAHZZ	PAOZZ	PADZZ	PAHZZ		.050	3120-00-678-6087	BEARING, END: CAMSHAFT 255073B 28265	EA	2	2
82	8	PAHZZ	PAOZZ	PADZZ	PAHZZ		.050	3120-00-973-5966	BEARING, CENTER: CAMSHAFT 40065A 28265	EA	2	2

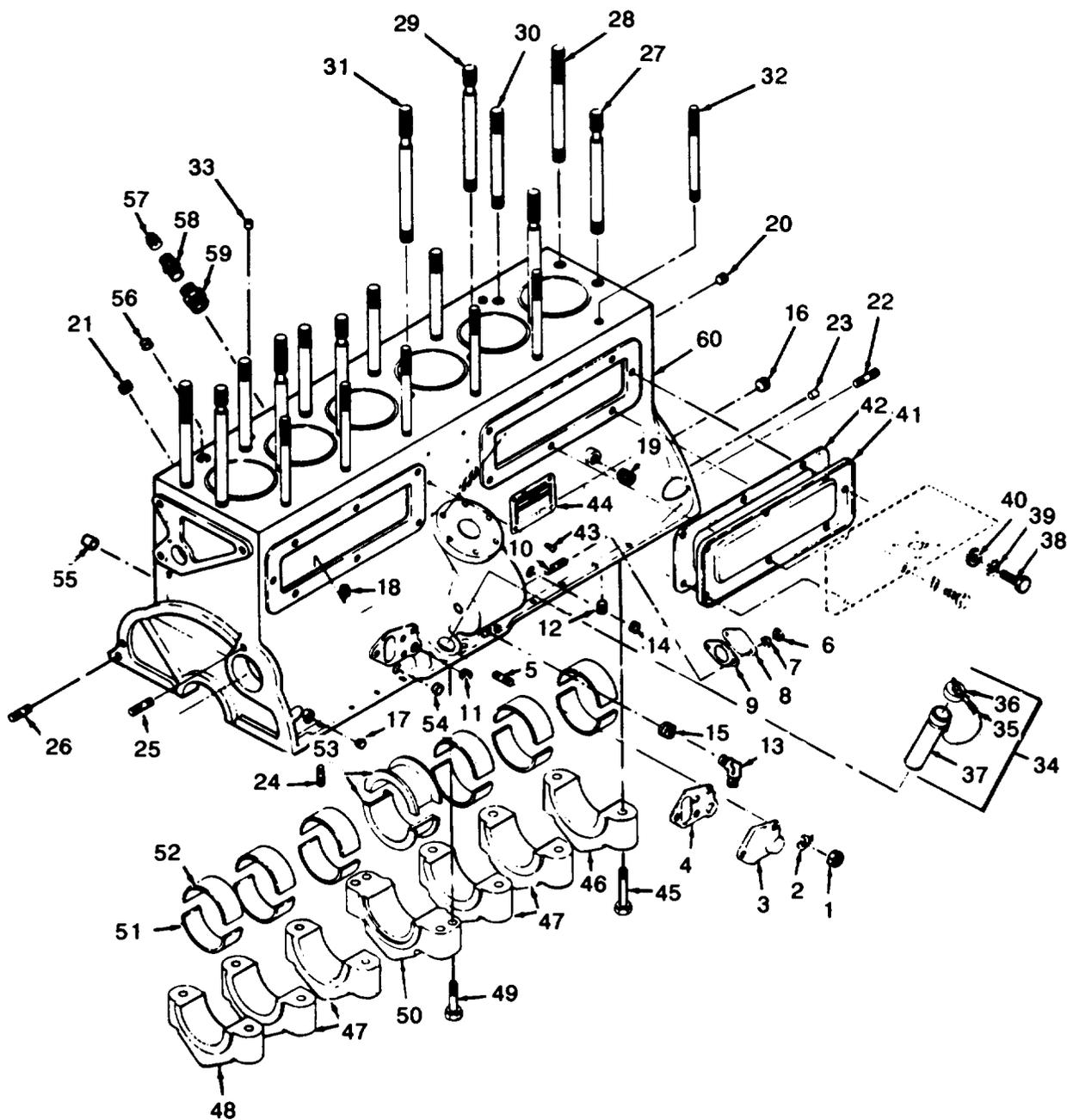

Figure 83. Cylinder block.

(1) ILLUSTRATION A FIG. NO.	(2) SMR CODE B ITEM NO.	(3)					(4) NATIONAL STOCK NUMBER	(5) DESCRIPTION REF NUMBER & MFR CODE	(6) USABLE ON CODE U/M	(7) QTY INC IN UNITS	(8) USMC QTY PER EQUIP
		A ARMY	B AIR FORCE	C NAVY	D USMC	A SSI					
83	1	PAHZZ	PAOZZ	PAOZZ	PAHZZ	D	.008 5310-00-732-0558	NUT, PLAIN, HEXAGON MS51967-8 96906	EA	2	24
83	2	PAHZZ	PAOZZ	PAOZZ	PAHZZ	D	.010 5310-00-637-9541	WASHER, LOCK: COVER MTG MS35338-46 96906	EA	2	104
83	3	XBHZZ	PAOZZ	XBGZZ	PAHZZ		2805-00-369-8782	COVER, HOLE: BLOCK 32059A 28265	EA	1	1
83	4	KFHZZ	PAOZZ	KFGZZ	KFHZZ		.040 5330-00-905-4392	GASKET: COVER (PART OF KIT, P/N 40-3094662A) 255561A 28265	EA	1	1
83	5	XBHZZ	PAOZZ	XBGZZ	PAHZZ		5307-00-927-2120	STUD, COVER 206024A 28265	EA	2	2
83	6	PAHZZ	PAOZZ	PAGZZ	PAHZZ	D	.008 5310-00-268-6093	NUT, PLAIN, HEXAGON: COVER MTG 28A 28265	EA	2	6
83	7	PAHZZ	PAOZZ	PAGZZ	PAHZZ	D	.010 5310-00-010-3320	WASHER, LOCK: COVER MTG 616A 28265	EA	2	2
83	8	XBHZZ	PAOZZ	XBGZZ	PAHZZ		2815-00-738-7924	COVER, TACHOMETER DRIVE 255761A 28265	EA	1	1
83	9	PAHZZ	PAOZZ	KFGZZ	PAHZZ		.040 5330-00-842-0363	GASKET: COVER 255772A 28265	EA	1	1
83		PAHHH	PBOZZ	XAHZZ	PAHHH		2815-00-132-9963	BLOCK ASSEMBLY, CYLINDER 292375AS 28265	EA	1	1
83	10	PAHZZ	PAOZZ	XBGZZ	PAHZZ	D	.008 5307-00-261-0408	STUD, PLAIN: TACHOMETER DRIVE COVER 3161A 28265	EA	2	2
83	11	PAHZZ	PAOZZ	PAGZZ	PAHZZ	D	.005 5340-00-324-2519	PLUG, EXPANSION 11683A 28265	EA	5	5
83	12	PAHZZ	PAOZZ	XBGZZ	PAHZZ	D	.008 4730-00-010-3885	PLUG, PIPE 103885 24617	EA	1	1
83	13	XBHZZ	PAOZZ	XBGZZ	XBHZZ			ELBOW 206278A 28265	EA	1	1
83	14	PAHZZ	PAOZZ	XBGZZ	PAHZZ	D	.008 4730-00-278-3397	PLUG, PIPE 59A 28265	EA	2	2
83	15	XBHZZ	XC	XBGZZ	XBHZZ			REDUCER 11813A 28265	EA	1	1
83	16	XBHZZ	PAOZZ	XBGZZ	XBHZZ			SETSCREW: BLOCK 205317A 28265	EA	1	1
83	17	XBHZZ	XC	XBGZZ	XBHZZ			PLUG, PIPE: BLOCK 40-000104A 28265	EA	1	1
83	18	PAHZZ	PAOZZ	XBGZZ	PAHZZ	D	.008 4730-00-010-3875	PLUG, PIPE: BLOCK 9409949 89345	EA	2	2
83	19	PAHZZ	PAOZZ	XBGZZ	PAHZZ	D	.008 4730-00-289-0094	PLUG, PIPE: CYLINDER BLOCK 221-1042 10988	EA	1	1
83	20	PAHZZ	PAOZZ	XBGZZ	PAHZZ	D	.008 4730-00-529-4958	PLUG, PIPE 7165A 28265	EA	1	1
83	21	PAHZZ	PAOZZ	XBGZZ	PAHZZ	D	.008 4730-00-010-3876	PLUG, PIPE: CYLINDER BLOCK WWP471 81348	EA	1	1

(1) ILLUSTRATION A	(2) SMR CODE A	(3) B	(4) NATIONAL STOCK NUMBER	(5) DESCRIPTION	(6) USABLE ON CODE	(7) QTY INC IN UNITS	(8) USMC QTY PER EQUIP						
								B	C	D	A	B	REF NUMBER & MFR CODE
FIG. NO.	ITEM NO.	ARMY	AIR FORCE	NAVY	USMC	SSI	REPL FACTOR						
83	22	PAHZZ	PAOZZ	XBGZZ	PAHZZ	D	.008	5307-00-466-7215	STUD, PLAIN: FLYWHEEL HOUSING 14907A 28265	EA	2	2	
83	23	XBHZZ	PAOZZ	XBGZZ	PAHZZ			5315-00-393-5887	DOWEL, CYLINDER BLOCK 11557A 28265	EA	4	4	
83	24	PAHZZ	PAOZZ	XBGZZ	PAHZZ	D	.008	5307-00-616-6016	STUD, PLAIN: FILLER BLOCK 11833A 28265	EA	2	2	
83	25	PAHZZ	PAOZZ	PBGZZ	PAHZZ	D	.008	5307-00-429-0140	STUD, PLAIN 12293A 28265	EA	2	1	
83	26	PAHZZ	PAOZZ	XBGZZ	PAHZZ	D	.008	5307-00-033-5489	STUD, PLAIN 4151A 28265	EA	1	1	
83	27	PAHZZ	PAOZZ	XBGZZ	PAHZZ	D	.008	5307-00-616-7216	STUD, PLAIN: CYLINDER HEAD 40-000-1619 28265	EA	1	1	
83	28	PAHZZ	PAOZZ	XBGZZ	PAHZZ	D	.008	5307-00-630-4836	STUD, PLAIN: CYLINDER 204591B 28265	EA	2	2	
83	29	PAHZZ	PAOZZ	XBGZZ	PAHZZ	D	.008	5307-00-616-7206	STUD, PLAIN: CYLINDER HEAD 40-0001618B 28265	EA	3	3	
83	30	PAHZZ	PAOZZ	XBGZZ	PAHZZ	D	.008	5307-00-623-1802	STUD, PLAIN: CYLINDER HEAD 203986B 28265	EA	5	5	
83	31	PAHZZ	PAOZZ	XBGZZ	PAHZZ	D	.008	5307-00-616-7203	STUD, PLAIN: CYLINDER HEAD 40-0001617B 28265	EA	3	3	
83	32	PAHZZ	PAOZZ	PAGZZ	PAHZZ	D	.008	5307-00-677-8889	STUD, PLAIN: CYLINDER HEAD 13814A 28265	EA	6	6	
83	33	XBHZZ	PAOZZ	XBGZZ	PAHZZ			5315-00-400-3619	DOWEL: CYLINDER HEAD 204601A 28265	EA	2	2	
83	34	PAOZZ	AOO	XBGZZ	XBHZZ				TUBE NECK ASSEMBLY: OIL FILL 40-0011155 28265	EA	1	1	
83	35	XBOZZ	PAOZZ	XBGZZ	PAHZZ			6115-00-830-6462	CHAIN, CAP 203329AS 28265	EA	1	1	
83	36	PAOZZ	PAOZZ	PAOZZ	PAOZZ	D	.027	2815-00-961-7876	CAP, TUBE: OIL FILL 40-0000146 28265	EA	1	1	
83	37	XBOZZ	XC	XBGZZ	XBOZZ				TUBE, OIL FILLER 40-3092409 28265	EA	1	1	
83	38	PAHZZ	PAOZZ	PAGZZ	PAHZZ	D	.008	5305-00-269-3209	SCREW, CAP, HEXAGON HEAD: VALVE TAPPET COVER MS90725-58 96906 4585A 28265	EA	6	30	
83	39	PAHZZ	PAOZZ	PAGZZ	PAHZZ	D	.010	5310-00-637-9541	WASHER, LOCK: VALVE TAPPET COVER MTG MS35338-46 96906	EA	1	104	
83	40	PAHZZ	PAOZZ	PAGZZ	PAHZZ		.040	5330-00-530-2523	GASKET: VALVE TAPPET COVER SCREW 76109A 28265	EA	6		
83	41	XBHZZ	XCO	XBGZZ	XBHZZ				PLATE, COVER: VALVE TAPPET 286013B 28265	EA	2	2	
83	42	PAHZZ	PAOZZ	KFGZZ	PAHZZ		.040	5330-00-615-1838	GASKET 40-0011906C 28265	EA	2	2	
83	43	XBOZZ	PAOZZ	XBGZZ	PAHZZ			5305-00-363-9695	SCREW, DRIE: INSTRUCTION PLATE MTG 2189A 28265	EA	4	4	

(1) ILLUSTRATION A	(1) FIG. NO.	(2) SMR CODE A	(2) B	(2) C	(2) D	(3) A	(3) B	(4) NATIONAL STOCK NUMBER	(5) DESCRIPTION REF NUMBER & MFR CODE	(6) USABLE ON CODE	(6) U/M	(7) QTY INC IN UNITS	(8) USMC QTY PER EQUIP	
														(2) AIR FORCE
	83	44	XBOZZ	XB	XBGZZ	MDOZZ			PLATE, INSTRUCTION: ENGINE 204509B 28265		EA	1	1	
	83	45	PAHZZ	PAOZZ	PAHZZ	PAHZZ	D	.008	5305-00-987-1132	SCREW, BEARING CAPS 288105A 23265		EA	12	12
	83	46	XBHZZ	XB	XBDZZ	XBHZZ			CAP, MAIN BEARING, FRONT 288100C 28265		EA	1	1	
	83	47	XBHZZ	XB	XBDZZ	XBHZZ			CAP, MAIN BEARING: INTERMEDIATE 288101C 28265		EA	4	4	
	83	48	XBHZZ	XB	XBDZZ	XBHZZ			CAP, MAIN BEARING: REAR 288102C 28265		EA	1	1	
	83	49	PAHZZ	PAOZZ	PAGZZ	PAHZZ	D	.008	5306-00-843-8563	BOLT, MACHINE: CENTER BEARING CAP 205351A 28265		EA	4	4
	83	50	XBHZZ	XB	XBDZZ	XBHZZ			CAP, MAIN BEARING: CENTER 285123C 28265		EA	1	1	
	83		PAHZZ	PAOZZ	PDDZZ	PAHZZ		.050	3120-00-857-0630	BEARING ASSEMBLY: MAIN, CRANKSHAFT 288106AS 28265		EA	1	1
	83	51	XAHZZ	XA	XADZZ	PAHZZ			3120-00-857-1043	BEARING, MAIN: LOWER 285129B 28265		EA	6	6
	83	52	XAHZZ	XA	XADZZ	PAHZZ			3120-01-014-8979	BEARING, MAIN: UPPER 208104B 28265		EA	6	6
	83	53	XAHZZ	XA	XADZZ	PAHZZ			3120-01-015-0714	BEARING, MAIN CENTER 285111B 28265		EA	2	2
	83	54	XBHZZ	XB	XBGZZ	XBHZZ			PLUG, PIPE 620A 28265		EA	1		
	83	55	XBHZZ	XB	XBGZZ	XBHZZ			PLUG, PIPE 1075A 28265		EA	1		
	83	56	XBHZZ	XB	XBGZZ	XBHZZ			PLUG, PIPE 11331A 28265		EA	1		
	83	57	XBHZZ	XB	XBGZZ	XBHZZ			PLUG, PIPE 415A 28265		EA	1		
	83	58	XBHZZ	XB	XBGZZ	XBHZZ			REDUCER 11813A 28265		EA	1		
	83	59	XBHZZ	XB	XBGZZ	XBHZZ			REDUCER 203359A 28265		EA	1		
	83	60	XAHZZ	XA	XAHZZ	XAHZZ			BLOCK, CYLINDER 40-3001-704E 28265		EA	1		
	83		PAFZZ	PAOZZ	PAHZZ	PAHZZ			5330-01-022-7996	GASKET SET 40-3094661A 28265		EA	1	
	83		PAFZZ	PAOZZ	PAHZZ	PAHZZ			5330-01-022-7995	GASKET SET 40-3094662A 28265		EA	1	

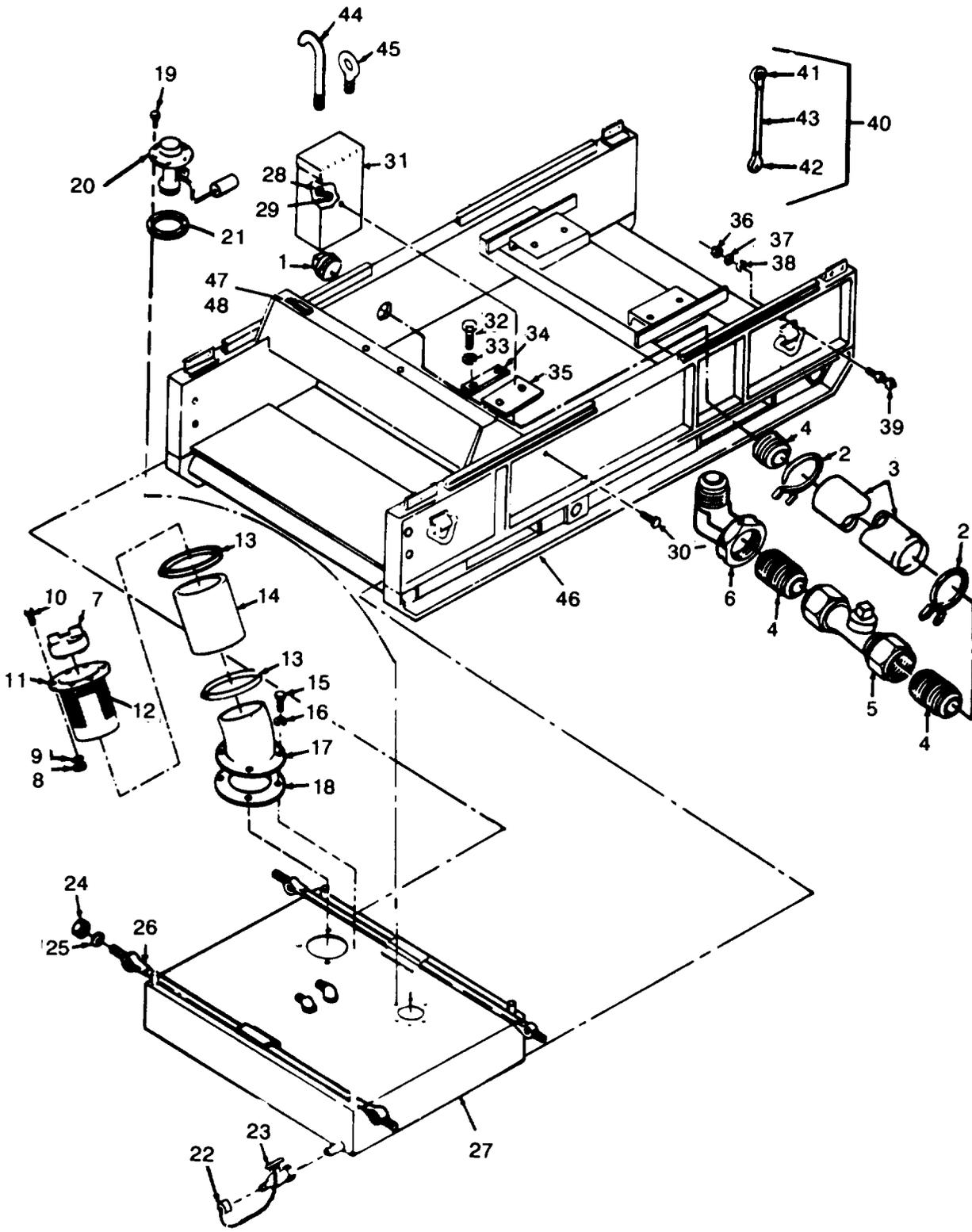

Figure 84. Fuel tank and skid base.

(1) ILLUSTRATION A FIG. NO.	(2) SMR CODE B ITEM NO.	A	B	C	D	(3) A SSI	B REPL FACTOR	(4) NATIONAL STOCK NUMBER	(5) DESCRIPTION REF NUMBER & MFR CODE	USABLE ON CODE	(6) U/M	(7) QTY INC IN UNITS	(8) USMC QTY PER EQUIP
GROUP 21 - BASE GROUP													
84	1	PAOZZ	PAOZZ	PAGZZ	PAOZZ	D	.005	4730-00-324-1483	PLUG, PIPE: OIL PAN DRAIN, 3/4 IN. PIPE 72-2175 30554 3-4SHPS 30780	EA	1	1	
84	2	PAOZZ	PAOZZ	PAGZZ	PAOZZ	D	.007	4730-01-005-7253	CLAMP, HOSE: OIL DRAIN M539326-26 96906	EA	2	2	
84	3	MOOZZ	PAOZZ	MGZ	MOOZZ				HOSE, OIL DRAIN 72-2128 30554 30554-72-2128 36024	EA	1	1	
84		PAOZZ	PAOZZ	PAGZZ	PAOZZ	D	.070	4720-00-401-9299	HOSE MS52130LAOGR 96906	EA	1	1	
84	4	PAOZZ	PAOZZ	PAGZZ	PAFZZ	D	.002	4730-00-196-1497	NIPPLE, PIPE: OIL DRAIN MS51953-102 96906	EA	3	3	
84	5	PAOZZ	PAOZZ	PAGZZ	PAFZZ	D	.008	4820-00-090-0554	COCK, SHUTOFF: OIL DRAIN 70-1512 30554 A400-4 16024	EA	1	1	
84	6	PAOZZ	PAOZZ	PAGZZ	PAFZZ	D	.002	4730-00-246-9218	ELBOW, PIPE: OIL PAN 4364A 28265	EA	1	1	
84	7	PAOZZ	PAOZZ	PAOZZ	PAOZZ		.027	2910-00-141-9758	CAP, FUEL FILTER M535645-1 96906	EA	1	1	
84	8	PAFZZ	PAOZZ	PAGZZ	PAFZZ	D	.008	5310-00-761-6882	NUT, PLAIN, HEXAGON: NECK MTG MS51967-2 96906	EA	4	109	
84	9	PAFZZ	PAOZZ	PAGZZ	PAFZZ	D	.010	5310-00-582-5965	WASHER, LOCK: NECT MTG MS35338-44 96906	EA	4	256	
84	10	PAFZZ	PAOZZ	PAGZZ	PAFZZ	D	.008	5305-00-068-0500	SCREW, CAP, HEXAGON HEAD: NECK MTG MS90725-3 96906	EA	4	179	
84	11	XBFZZ	PAOZZ	XBGZZ	XBFZZ				NECK, FILLER, FUEL 72-2018 30554	EA	1	1	
84	12		PAOZZ					2910-00-752-9138	FILLER TUBE (SCREEN) MS90908-12 96906	EA	1	1	
84	13	PAFZZ	PAOZZ	PAGZZ	PAFZZ	D	.007	4730-00-908-6294	CLAMP, HOSE MS35842-16 96906	EA	2	2	
84	14	PAFZZ	PAOZZ	PAGZZ	PAFZZ		.070	4720-00-375-5959	HOSE, FUEL FILLER NECK 72-2083 30554 30554-72-2083 36024	EA	1	1	
84	15	PAFZZ	PAOZZ	PAGZZ	PAFZZ	D	.008	5305-00-068-0500	SCREW, CAP, HEXAGON HEAD: FUEL ADAPTER MTG MS90725-3 96906	EA	6	179	
84	16	PAFZZ	PAOZZ	PAGZZ	PAFZZ	D	.010	5310-00-582-5965	WASHER, LOCK: FUEL ADAPTER MTG MS35338-44 96906	EA	6	256	
84	17	XBFZZ	XA	XBGZZ	XBFZZ				ADAPTER, FUEL: TANK 72-2032 30554 30554-72-2032 36024	EA	1	1	
84	18	PAFZZ	PAOZZ	PAGZZ	PAFZZ		.040	5330-00-615-1834	GASKET, ADAPTER 72-2047 30554 30554-72-2047 36024	EA	1	1	
84	19	PAFZZ	PAOZZ	PAGZZ	PAFZZ	D	.008	5305-00-191-6226	SCREW, WASHER: FUEL SENSOR MTG 69-662-64 30554 P15121-64 45722	EA	5	42	

(1) ILLUSTRATION		(2) SMR CODE				(3)		(4)	(5)	(6)	(7)	(8)	
A	B	A	B	C	D	A	B	NATIONAL STOCK NUMBER	DESCRIPTION	USABLE ON CODE	QTY INC IN UNITS	USMC QTY PER EQUIP	
FIG. NO.	ITEM NO.	ARMY	AIR FORCE	NAVY	USMC	SSI	REPL FACTOR		REF NUMBER & MFR CODE	U/M			
84	20	PAFZZ	PAOZZ	PAGZZ	PAFZZ		.050	6680-00-363-4001	SENSOR, FUEL 72-2271 30554 507-CZ 57733	EA	1	1	
84	21	PAFZZ	PAOZZ	PAFZZ	PAFZZ			5330-01-268-2615	GASKET GK0023 09527	EA	1	1	
84	22	XBOZZ	PAOZZ	XBGZZ	XBOZZ				CAP. TUBE: FUEL TANK DRAIN 69-539-2 30554	EA	1	1	
84	23	PAOZZ	PAOZZ	XBOZZ	PAOZZ	D	.010	4820-00-595-3191	VALVE, DRAIN: FUEL TANK 72-2297-2 30554 695 79470	EA	1	1	
84	24	PAFZZ	PAOZZ	XBGZZ	PAFZZ	D	.008	5310-00-807-1469	NUT, SELF-LOCKING: STRAP MTG MS21044D5 96906	EA	4	4	
84	25	PAFZZ	PAOZZ	PAGZZ	PAFZZ	D	.010	5310-00-081-4219	WASHER, FLAT: STRAP MTG MS27183-12 96906	EA	4	30	
84	26	XBFZZ	PAOZZ	XBGZZ	PAFZZ			2910-01-241-7508	STRAP, RETAINING: FUEL TANK 81-2002 30554 30554-72-2028 36024	EA	2	2	
84	27	XBFZZ	XBOZZ	XBGZZ	XBFZZ				TANK ASSEMBLY, FUEL 72-2020 30554 30554-72-2020 36024	EA	1	1	
84	28	PAFZZ	PAOZZ	PAOZZ	PAFZZ	D	.008	5310-00-880-7744	NUT, PLAIN, HEXAGON: TOOL BOX MTG MS51967-5 96906	EA	2	24	
84	29	PAFZZ	PAOZZ	PAOZZ	PAFZZ	D	.010	5310-00-584-5272	WASHER, LOCK: TOOL BOX MTG MS35338-48 96906	EA	2	41	
84	30	PAFZZ	PAOZZ	PAOZZ	PAFZZ	D	.008	5306-00-225-8497	BOLT, MACHINE: TOOL BOX MTG MS90725-32 96906	EA		44	
84	31	XBFZZ	PAOZZ	XBOZZ	XBFZZ				BOX, TOOL 72-2111 30554 30554-72-2111 36024	EA	1		
84	32	PAFZZ	PAOZZ	PAGZZ	PAFZZ	D	.008	5305-00-068-0500	SCREW, CAP, HEXAGON HEAD: BLANK PANEL MTG MS90725-3 96906	EA	2	179	
84	33	PAFZZ	PAOZZ	PAGZZ	PAFZZ	D	.010	5310-00-582-5965	WASHER, LOCK: BLANK PANEL MTG MS35338-44 96906	EA	4	256	
84	34	XBFZZ	PAOZZ	XBGZZ	XBFZZ				PANEL, BLANK 72-2035 30554 30554-72-2035 36024	CLA, CLB CLC	EA	1	1
84	35	XBFZZ	MOOZZ		XBFZZ				PANEL, BLANK 72-0893 30554	CZN, CAM, DGG	EA	1	1
84	36	PAFZZ	PAOZZ	PAGZZ	PAFZZ	D	.008	5310-00-913-3366	NUT, PLAIN, HEXAGON: TERMINAL STUD MS51922-11 96906	EA	1	1	
84	37	PAFZZ	PAOZZ	PAGZZ	PAFZZ	D	.010	5310-00-081-4219	WASHER, FLAT: TERMINAL STUD MS27183-12 96906	EA	1	1	
84	38	PAFZZ	PAOZZ	PAGZZ	PAFZZ	D	.008	5310-00-880-7744	NUT, PLAIN, HEXAGON MS51967-5 96906	EA	1	1	
84	39	PAFZZ	PAOZZ	XBGZZ	PAFZZ	D	.003	5940-00-234-3383	TERMINAL, STUD: GROUNDING 69-692-6 30554 30554-69-692-6 36024	EA	1	1	

TM9-6115-465-24P
 TO35CZ-3-446-4
 NAVFAC P-8-625-24P
 SL-4-06858B/06859D

(1) ILLUSTRATION		(2) SMR CODE				(3)		(4) NATIONAL STOCK NUMBER	(5) DESCRIPTION	(6) USABLE ON CODE	(7) QTY INC IN UNITS	(8) USMC QTY PER EQUIP
A FIG. NO.	B ITEM NO.	A ARMY	B AIR FORCE	C NAVY	D USMC	A SSI	B REPL FACTOR	REF NUMBER & MFR CODE	U/M			
84		MOFZZ	PAOZZ	AGGZZ	AFPZZ			9505-00-804-3814	TERMINAL CLIP (WIRE 0.042 IN. DIA) MANUFACTURE FROM:			
84	40	MFOZZ	AOOZZ		AFPZZ				HARNESS 72-2294-2 30554 MANUFACTURE FROM:	DGG	EA	1 1
84	41	PAFZZ	PAOZZ		PAFZZ	D	.023	5940-00-011-4996	LUG, TERMINAL MS20659-145 96906	DGG	EA	1
84	42	PAFZZ	PAOZZ		PAFZZ	D	.023	5940-00-115-5023	LUG, TERMINAL MS20659-124 96906	DGG	EA	1
84	43	PAFZZ	PAOZZ		PAFZZ	D	.080	6145-00-284-0657	WIRE, ELECTRICAL M5086/2-8-9 81349	DGG	FT	V
84	44	XBFZZ	MFO	XBGZZ	XBFZZ				HOOK, SUPPORT 72-2136 30554 30554-72-2136 36024		EA	1 1
84	45	XBFZZ	XB	XBGZZ	XBFZZ				BOLT, EYE GENERATOR 72-2451 30554 2050 71177		EA	1 1
84		XBFZZ	XB	XAGGG	XBFZZ				SKID BASE ASSEMBLY 72-2390 30554 30554-72-2390 36024	CLA, CLB, CZN, CZM	EA	1 1
84		XBFZZ	XB	XAGGG	XBFZZ				SKID BASE ASSEMBLY 72-2391 30554 30554-72-2391 36024	CLC, DGG	EA	1 1
84	46	XBFZZ	XB	XAHZZ	XBFZZ				SKID BASE 72-2001 30554 30554-72-2001 36024		EA	1 1
84	47	PAFZZ							SCREW AND CAPTIVE LOCKWASHER 69-662-35 30554		EA	1 1
84	48	PAFZZ							CLAMP, CUSHIONED MS21334-30 96906		EA	1 1

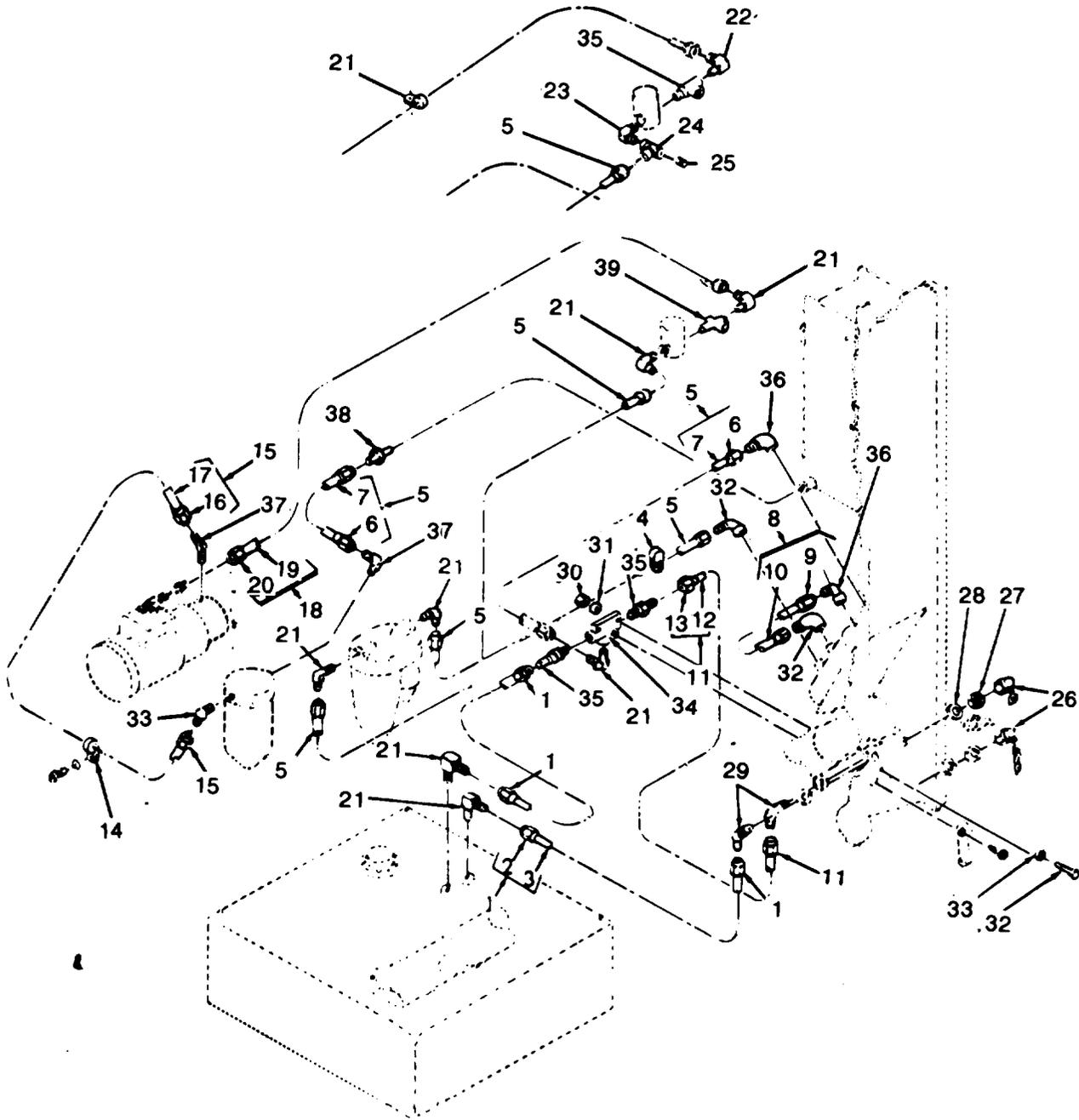

Figure 85. Fuel lines and fittings.

(1) ILLUSTRATION A FIG. NO.	(2) SMR CODE B ITEM NO.	A	B	C	D	(3) A SSI	B REPL FACTOR	(4) NATIONAL STOCK NUMBER	(5) DESCRIPTION REF NUMBER & MFR CODE	(6) USABLE ON CODE U/M	(7) QTY INC IN UNITS	(8) USMC QTY PER EQUIP
85	1	MFOZZ	AOO	AGGGG	MFOZZ				HOSE ASSEMBLY, FUEL MS28741-5-0320 96906 MANUFACTURE FROM:	EA	2	2
85	2	PAFZZ	PAOZZ	PAGZZ	PAFZZ	D	.008	4730-00-842-2201	FITTING MS24587-5 96906	EA	4	8
85	3	PAFZZ	PAOZZ	PAGZZ	PAFZZ	D	.070	4720-00-289-9197	HOSE MILH8794-5 81349	FT	3	35
85	4	PAOZZ	PAOZZ	PADZZ	PAOZZ	D	.023	5340-00-053-8994	CLAMP, LOOP MS21333-126 96906	EA	1	1
85	5	MFOZZ	PAOZZ	PAOZZ	MFOZZ			4720-00-931-7879	HOSE ASSEMBLY, FUEL MS28741-5-0150 96906 MANUFACTURE FROM:	EA	4	4
85	6	PAFZZ	PAOZZ	PAGZZ	PAFZZ	D	.008	4730-00-842-2201	FITTING MS24587-5 96906	EA	2	8
85	7	PAFZZ	PAOZZ	PAGZZ	PAFZZ	D	.070	4720-00-289-9197	HOSE MILH8794-5 81349	FT	2	35
85	8	MFOZZ	MOO	AGGZZ	MFOZZ				TUBE ASSEMBLY 72-2151 30554 30554-72-2151 36024	EA	1	V
85	9	PAFZZ	PAOZZ	PAGZZ	PAFZZ	D	.008	4730-00-603-0731	NUT, TUBE 72-2025-1 30554 ANB17-5 88044	EA	2	6
85	10	PAFZZ	PAOZZ	PAGZZ	PAFZZ	D	.070	4710-00-640-5410	TUBE 72-2151-1 30554 MILT3520COMPOTYPE3 81349	FT	V	V
85	11	MFOZZ	PAOZZ	AGGGG	MFOZZ				TUBE ASSEMBLY 72-2153 30554 30554-72-2153 36024	EA	1	1
85	12	PAFZZ	PAOZZ	PAGZZ	PAFZZ	D	.070	4710-00-640-5410	TUBE 72-2153-1 30554 MILT3520COMPOTYPE3 81349	FT	V	V
85	13	PAFZZ	PAOZZ	PAGZZ	PAFZZ	D	.008	4730-00-585-7635	NUT, TUBE 72-2025-1 30554 C5115X5 79470	EA	2	4
85	14	PAFZZ	PAOZZ	XBGZZ	PAFZZ	D	.023	5340-00-630-4813	CLAMP, HOSE RETAINING 40-0002727A 28265	EA	1	1
85	15	MFOZZ	PAOZZ	PAOZZ	MFOZZ			4720-01-022-3923	HOSE ASSEMBLY, FUEL: FILTER TO INJECTION PUMP MS28741-5-0280 96906 MANUFACTURE FROM:	EA	1	1
85	16	PAFZZ	PAOZZ	PAGZZ	PAFZZ	D	.008	4730-00-842-2201	FITTING, HOSE MS24587-5 96906	EA	2	8
85	17	PAFZZ	PAOZZ	PAGZZ	PAFZZ	D	.070	4720-00-289-9197	HOSE MILH8794-5 81349	FT	3	35
85	18	MFOZZ	MOO	XBGZZ	MFOZZ				LINE, RETURN INJECTOR 72-2119 30554 30554-72-2119 36024	EA	1	1
85	19	PAFZZ	PAOZZ	XAGZZ	PAFZZ	D	.070	4710-00-640-5410	TUBE MILT3520COMPOTYPE3 81349	FT	4	V

(1) ILLUSTRATION		(2) SMR CODE				(3)			(4) NATIONAL STOCK NUMBER	(5) DESCRIPTION	(6) USABLE ON CODE	(7) QTY INC IN UNITS	(8) USMC QTY PER EQUIP	
A FIG. NO.	B ITEM NO.	A ARMY	B AIR FORCE	C NAVY	D USMC	A SSI	B REPL FACTOR		REF NUMBER & MFR CODE	U/M				
85	20	PAFZZ	PAOZZ	XAGZZ	PAFZZ	D	.008	4370-00-585-7635	NUT, TUBE 72-2025-1 30554 C5115X5 79470	EA	2	2		
85	21	PAFZZ	PAOZZ	PAFZZ	PAFZZ	D	.023	5340-00-809-1492	CLAMP, LOOP MS21333-100 96906	DGG	EA	1		
85	22	PAFZZ	PAOZZ	PAGZZ	PAFZZ	D	.008	4730-00-121-0138	ELBOW, FUEL HOSE 70-1109-6 30554 5-4CTXS 45681	CLA, CLB, CLC, CZN CZM	EA	9	10	
85	23	PAFZZ	PAOZZ		PAFZZ	D	.008		ELBOW 72-2084 30554 1/4CR-S 30780	DGG	EA	1	1	
85	24	PAFZZ	PAOZZ		PAFZZ	D	.008	4730-01-048-9769	TEE 72-2085 30554 1/4MMOS 30780	DGG	EA	1	1	
85	25	PAFZZ	PAOZZ		PAFZZ	D	.008	4730-00-044-4577	PLUG 72-2086 30554 1/4SHP-S 30780	DGG	EA	1	1	
85	26	PAFZZ	PAOZZ	PAGZZ	PAGZZ	D	.008	4730-00-812-1333	CAP, TUBE 69-539-2 30554 30554-69-39-2 36024	EA	2			
85	27	PAFZZ	PAOZZ	XBGZZ	PAFZZ	D	.008	4730-01-020-5607	LOCKNUT: ELBOW MTG MS51860-54 96906	EA	2	2		
85	28	PAFZZ	PAOZZ	PAGZZ	PAGZZ	D	.010	5310-00-809-5997	WASHER, FLAT: ELBOW MTG MS27183-17 96906	EA	4	21		
85	29	PAFZZ	PAOZZ	XBGZZ	PAFZZ	D	.006	4730-01-039-6757	ELBOW, TUBE MS51509A5 96906	EA	2	2		
85	30	PAFZZ	PAOZZ	PAGZZ	PAFZZ	D	.008	5310-00-761-6882	NUT, PLAIN, HEXAGON: VALVE MTG MS51967-2 96906	EA	2	109		
85	31	PAFZZ	PAOZZ	PAGZZ	PAFZZ	D	.010	5310-00-582-5965	WASHER, LOCK: VALVE MTG MS35338-44 96906	EA	2	256		
85	32	PAFZZ	PAOZZ	PAGZZ	PAFZZ	D	.008	5305-00-068-0502	SCREW, CAP MS90725-6 96906	EA	2	179		
85	33	PAFZZ	PAOZZ	PAGZZ	PAFZZ	D	.010	5310-00-823-8804	WASHER, FLAT: VALVE MTG MS27183-9 96906	EA	2	45		
85	34	PAFZZ	PAOZZ	PAGZZ	PAFZZ	D	.010	4820-00-209-1562	VALVE: 3-WAY 69-774 30554 SP-2201 70411	EA	1	1		
85	35	XBFZZ	PAOZZ	XBOXX	XBFZZ				ADAPTER, TUBE MS51819-36 96906	CLA, CLB, CLC, CZN CZM	EA	1	4	
85	35	PAFZZ	MOO		PAFZZ	D	.008	4730-00-141-1092	ADAPTER, TUBE 70-1112-36 30554	DGG	EA	1	4	
85	36	PAFZZ	PAOZZ	XBGZZ	PAFZZ	D	.008	4730-01-005-6945	ELBOW MS51813-4 96906	EA	4	4		
85	37	PAFZZ	PAOZZ	XBGZZ	PAFZZ	D	.008	4730-01-024-1311	ELBOW 40-0005529A 28265	CLA, CLB CLC, CZN, CZM	EA	2	2	
85	37	PAFZZ	PAOZZ		PAFZZ	D	.008	4730-00-113-0567	ELBOW 70-1491-36 30554	DGG	EA	2	2	

TM9-6115-465-24P
 TO35CZ-3-446-4
 NAVFAC P-8-625-24P
 SL-4-06858B/06859D

(1) ILLUSTRATION		(2) SMR CODE				(3)		(4) NATIONAL STOCK NUMBER	(5) DESCRIPTION	(6) USABLE ON CODE	(7) QTY INC IN UNITS	(8) USMC QTY PER EQUIP
A FIG. NO.	B ITEM NO.	A ARMY	B AIR FORCE	C NAVY	D USMC	A SSI	B REPL FACTOR	REF NUMBER & MFR CODE	CLA, CLB CLC, CZN CZM	U/M		
85	38	KBFZZ	PAOZZ	XBGZZ		XBFZZ		ADAPTER MS51819-36 96906	EA		2	4
85	38	PAFZZ	PAOZZ		PAFZZ	D	.008	4730-00-618-8497 ADAPTER 72-2043 30554	DGG	EA	2	4
85	39	PAFZZ	PAOZZ	XBGZZ	PAFZZ	D	.008	4730-00-619-9362 TEE MS39164-4 96906	EA		1	1

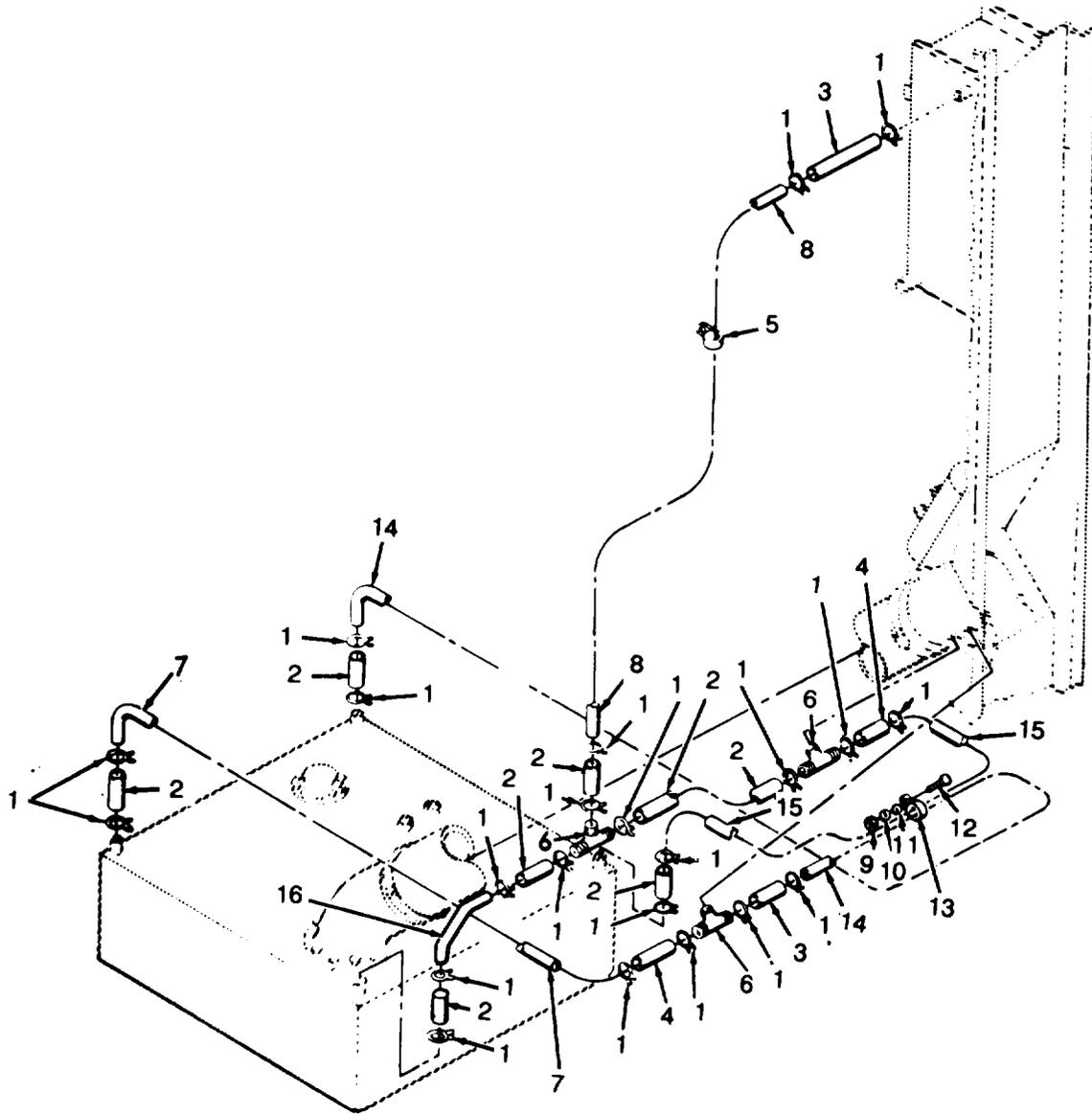

Figure 86. Fuel vent lines.

(1) ILLUSTRATION		(2) SMR CODE				(3)		(4) NATIONAL STOCK NUMBER	(5) DESCRIPTION	(6) USABLE ON CODE	(7) QTY INC IN UNITS	(8) USMC QTY PER EQUIP
A FIG. NO.	B ITEM NO.	A ARMY	B AIR FORCE	C NAVY	D USMC	A SSI	B REPL FACTOR	REF NUMBER & MFR CODE	U/M			
86	1	PAOZZ	PAOZZ	PAGZZ	PAOZZ	D	.007	CLAMP, LOOP MS39326-8 96906	EA	16	22	
86	2	MOOZZ	MOO	MOOZZ	MOOZZ			HOSE, VENT 72-2110-1 30554 30554-72-2110-1 64024 MANUFACTURE FROM:	EA	7	9	
86		PAOZZ	PAOZZ	PAGZZ	PAOZZ	D	.070	4720-00-278-4892 HOSE MILH13444TYPE1 (12 IN. REQUIRED)	FT	V	V	
86	3	MOOZZ	PAOZZ	MOOZZ	MOOZZ			HOSE, VENT 72-2110-4 30554 30554-72-2110-4 64024 MANUFACTURE FROM:	EA	3	9	
86		PAOZZ	PAOZZ	PAGZZ	PAOZZ	D	.070	4720-00-278-4892 HOSE MILH13444TYPE1 (32 IN. REQUIRED)				
86	4	MOOZZ	MOO	MOOZZ	MOOZZ			HOSE, VENT 72-2110-3 30554 MANUFACTURE FROM:	EA	1	3	
86		PAOZZ	PAOZZ	PAOZZ	PAOZZ	D	.070	4720-00-278-4892 HOSE MILH13444TYPE1 (IN. REQUIRED)				
86	5	XBOZZ	PAOZZ	PAOZZ	PAOZZ	D	.013	5340-00-809-1492 CLAMP, LOOP MS21333-100 96906	CLA, CLB, CLC, CZN CZM	EA	2	3
86	5	PAOZZ	PAOZZ		PAOZZ	D	.013	5340-00-809-1492 CLAMP, LOOP MS21333-100 96906	DGG	EA	1	3
86	6	PAOZZ	PAOZZ	XBGZZ	PAOZZ	D	.008	4730-00-621-1036 TEE, HOSE 72-2094 30554 224-8 93061	EA	3		
86	7	PAOZZ	PAOZZ	XBOZZ	PAOZZ	D	.070	4710-00-640-5410 TUBE 72-2122 30554 MILY3520COMPOTYPE3 81349	EA	1	1	
86	8	PAOZZ	PAOZZ	XBOZZ	PAOZZ	D	.070	4710-00-640-5410 TUBE, DAY TANK 72-2126 30554 MILT3520 81349	FT	1	1	
86	9	PAOZZ	PAOZZ	PAOZZ	PAOZZ	D	.008	5310-00-880-7744 NUT, FLAIN, HEXAGON: CLAMP MTG MS51967-5 96906	EA	2	24	
86	10	PAOZZ	PAOZZ	PAOZZ	PAOZZ	D	.010	5310-00-582-5965 WASHER, LOCK: CLAMP MTG MS35338-44 96906	EA	1		
86	11	PAOZZ	PAOZZ	PAOZZ	PAOZZ	D	.010	5310-00-018-4219 WASHER, FLAT: CLAMP MTG MS27183-12 96906	EA	1		
86	12	PAOZZ	PAOZZ	PAGZZ	PAOZZ	D	.008	5306-00-225-8497 BOLT, MACHINE: CLAMP MTG MS90725-32 96906	EA	1		
86	13	PAOZZ	PAOZZ	XBHZZ	PAOZZ	D	.008	5340-00-486-1765 CLAMP, LOOP MS21333-48 96906	EA	3	3	
86	14	XBOZZ	PAOZZ	XBOXX	PAOZZ	D	.070	4710-00-640-5410 TUBE, FUEL VENT 72-2123 30554 MILT3520COMPOTYPE3 81349	FT	5	1	
86	15	XBOZZ	PAOZZ	XBOZZ	PAOZZ	D	.070	4710-00-640-5410 TUBE, VENT 722125 30554 MILT3520COMPOTYPE3 81349	EA	1	1	

TM9-6115-465-24P
 TO35CZ-3-446-4
 NAVFAC P-8-625-24P
 SL-4-06858B/06859D

(1) ILLUSTRATION		(2) SMR CODE				(3)		(4) NATIONAL STOCK NUMBER	(5) DESCRIPTION	(6) USABLE ON CODE	(7) QTY INC IN UNITS	(8) USMC QTY PER EQUIP
A FIG. NO.	B ITEM NO.	A ARMY	B AIR FORCE	C NAVY	D USMC	A SSI	B REPL FACTOR	REF NUMBER & MFR CODE	U/M			
86	16	XBOZZ	PAOZZ	XBOZZ	PAOZZ	D	.070	4710-00-640-5410	TUBE, FUEL VENT 72-2146 30554 MILT3520COMPOTYPE3 81349	EA	1	1
86		PAOZZ	PAOZZ		PAOZZ	D	.013	5340-00-057-3037	CLAMP, LOOP MS21333-111 96906	EA	1	1

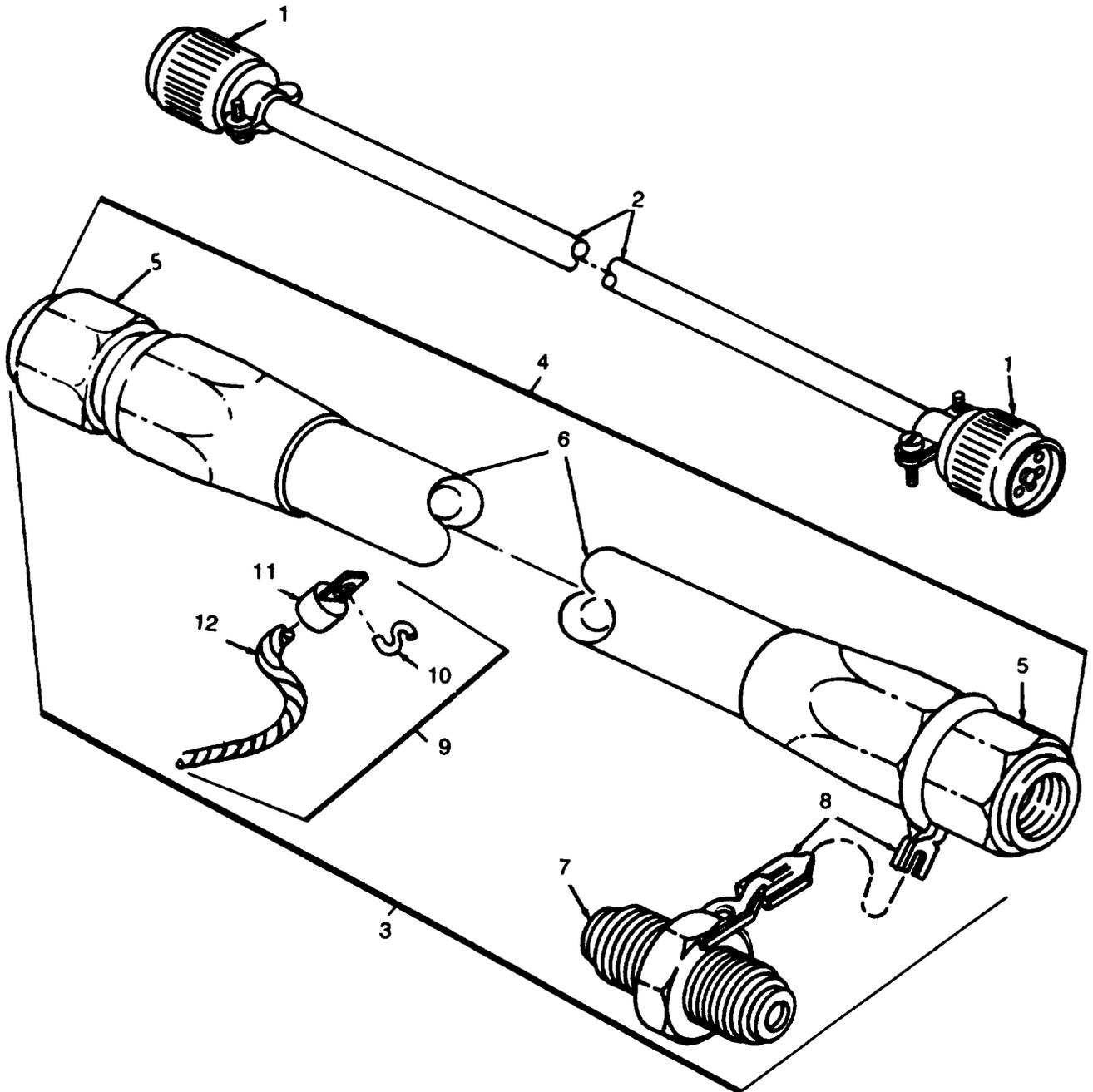

Figure 87. Accessory items.

(1) ILLUSTRATION		(2) SMR CODE				(3)		(4) NATIONAL STOCK NUMBER	(5) DESCRIPTION	(6) USABLE ON CODE	(7) QTY INC IN UNITS	(8) USMC QTY PER EQUIP
A FIG. NO.	B ITEM NO.	A ARMY	B AIR FORCE	C NAVY	D USMC	A SSI	B REPL FACTOR	REF NUMBER & MFR CODE	U/M			
GROUP 22-ACCESSORY ITEMS												
87		MFOFZ	AFO	XBGZZ	PAFZZ			CABLE, PARALLEL 69-772-2 30554 30554-69-772-2 36024 MANUFACTURE FROM:	EA	1		
87	1	PAFZZ	PAOZZ	XAGZZ	PAFZZ	D	.023	5335-00-211-0783	CONNECTOR, PLUG MS3106F18-4S 96906	EA	2	
87	2	PAFZZ	PAOZZ	XBGZZ	PAFZZ	D	.020	6145-01-015-9469	CABLE, COPPER CO-04HDF4-16-0500 81349	FT	V	
87	3	XBOZZ	AFO	XBGZZ	AFOZZ			LINE, FUEL AUXILIARY 69-668 30554 FA1493FFF3000 01276	EA	1		
87	4	PAFZZ	AFO	AGZZZ	AFOZZ			LINE, FUEL AUXILIARY MS28741-5-2992 96906	EA	1		
87	5	PAFZZ	PAOZZ	PAGZZ	PAFZZ	D	.008	4730-00-842-2201	FITTING, HOSE MS24587-5 96906	EA	2	
87	6	PAFZZ	PAOZZ	PAGZZ	PAFZZ	D	.070	4720-00-289-9197	HOSE, RUBBER MILH8794-5 81349	FT	V	
87	7	PAOZZ	PAOZZ	XBGZZ	PAOZZ	D	.008	4730-00-040-7450	UNION, FLARED 5LHBTXB 45681	EA	1	
87	8	XBOZZ	XB	XBGZZ	XBOZZ			CHAIN RRC271TYPE2CLASS6B 81348	FT	V		
87	9	MOOZZ	MOO	XBOZZ	MOOZZ			CORD ASSEMBLY 72-2115 30554 30554-72-2115 36024	EA	1		
87	10	PAOZZ	PAOZZ	PAOZZ	PAOZZ	D	.005	4030-00-780-9350	HOOK, CHAIN MS87006-13 96906	EA	2	
87	11	PAOZZ	PAOZZ	PAOZZ	PAOZZ	D	.023	5940-00-115-2677	LUG, TERMINAL MS20659-144 96906	EA	2	
87	12	PAOZZ	PAOZZ	XBOZZ	PAOZZ		.040	4020-00-270-8245	ROPE, NYLON MILR17343 81349	FT	V	
87		PAFZZ	PAOZZ	XBOZZ	PAOZZ			5320-00-510-7823	RIVET: PLATE MTG M24243-1B402 81349	EA	8	
87		PAFZZ	PAOZZ	XBOZZ	PAOZZ			5320-00-303-1060	RIVET: PLATE MTG M24243-1B502 81349	EA	64	
87		PAFZZ	PAOZZ	XBOZZ	PAOZZ			5320-00-938-6713	RIVET: PLATE MTG M24243-1B504 81349	EA	4	
87		PAFZZ	PAOZZ	XBOZZ	PAOZZ			4730-00-865-6597	RIVET: PLATE MTG M24243-1B402 81349	EA	8	
87		XBFZZ	XB	XBOZZ	MDOZZ			PLATE, INSTRUCTION 72-2907 30554 30554-72-2907 36024	CLA, CLB CLC, DGG	EA	1	
87		XBOZZ	XB	XBOZZ	MDOZZ			PLATE, INSTRUCTION 72-2908 30554 30554-72-2908 36024	CLA, CLB CLC, DGG	EA	1	
87		XBOZZ	XB	XBOZZ	MDOZZ			PLATE, IDENTIFICATION 72-2909 30554 30554-72-2909 36024	CLA, CLB	EA	1	

(1) ILLUSTRATION A FIG. NO.	(2) SMR CODE A B ARMY AIR FORCE	(3) C D NAVY USMC SSI	(4) NATIONAL STOCK NUMBER B REPL FACTOR	(5) DESCRIPTION REF NUMBER & MFR CODE	(6) USABLE ON CODE U/M	(7) QTY INC IN UNITS	(8) USMC QTY PER EQUIP
87	XBOZZ XB	XBOZZ MDOZZ		PLATE, IDENTIFICATION 72-2910 30554 30554-72-2910 36024	CLC, DGG EA	1	
87	XBOZZ XB	XBOZZ MDOZZ		PLATE, INSTRUCTION 72-2911 30554 30554-72-2911 36024	CLA, CLB CLC, DGG EA	1	
87	XBOZZ XB	XBOZZ MDOZZ		PLATE, IDENTIFICATION 72-2916 30554 30554-72-2916 36024	CLA EA	1	
87	XBOZZ XB	XBOZZ MDOZZ		PLATE, IDENTIFICATION 72-2914 30554 30554-72-2914 36024	CLB EA	1	
87	XBOZZ XB	XBOZZ MDOZZ		PLATE, IDENTIFICATION 72-2915 30554 305544-72-2915 36024	CLC, DGG EA	1	
87	XBOZZ XB	XBOZZ MDOZZ		PLATE, INFORMATION 72-2920 30554 30554-72-2920 36024	CLC, DGG EA	1	
87	XBOZZ XB	XBOZZ MDOZZ		PLATE, INSTRUCTION 72-2925 30554 30554-72-2925 36024	CLA, CLB CLC, DGG EA	1	
87	XBOZZ XB	XBOZZ MDOZZ		PLATE, INSTRUCTION 72-2926 30554 30554-72-2926 36024	CLA, CLB CLC, DGG EA	1	
87	XBOZZ XB	XBOZZ MDOZZ		PLATE, DIAGRAM 72-2928 30554 30554-72-2928 36024	CLA, CLB EA	1	
87	XBOZZ XB	XBOZZ MDOZZ		PLATE, DIAGRAM 72-2929 30554 30554-72-2929 36024	CLA EA	1	
87	XBOZZ XB	XBGZZ MDOZZ		PLATE, INSTRUCTION 72-2876 30554 30554-72-2876 36024	CLA, CLB CLC, DGG EA	1	
87	XBOZZ XB	XBGZZ MDOZZ		PLATE, INSTRUCTION 70-1482 30554 30554-70-1482 36024	CLA, CLB CLC, DGG EA	1	
87	XBOZZ XB	XBOZZ MDOZZ		PLATE, INSTRUCTION: ELECTRICAL WINTERIZATION 30554-72-2877 36024	CLA, CLB CLC, DGG EA	1	
87	XBOZZ XB	MDOZZ		PLATE, DESIGNATION 70-1332 30554	DGG EA	1	
87	XBOZZ XB	MDOZZ		PLATE, DIAGRAM 72-2931 30554	DGG EA	1	
87	XBOZZ XB	MDOZZ		PLATE, DESIGNATION 70-1329 30554	DGG EA	1	
87	XBOZZ XB	MDOZZ		PLATE, INSTRUCTION 70-1481 30554	DGG EA	1	
87	XBOZZ XB	MDOZZ		PLATE, IDENTIFICATION 72-0504-7 30554	DGG EA	1	
87	XBOZZ XB	MDOZZ		PLATE, INFORMATION 70-2919 30554	DGG EA	1	

TM9-6115-465-24P
 TO35CZ-3-446-4
 NAVFAC P-8-625-24P
 SL-4-06858B/06859D

(1) ILLUSTRATION		(2) SMR CODE				(3)		(4) NATIONAL STOCK NUMBER	(5) DESCRIPTION	(6) USABLE ON CODE	(7) QTY INC IN UNITS	(8) USMC QTY PER EQUIP
A FIG. NO.	B ITEM NO.	A ARMY	B AIR FORCE	C NAVY	D USMC	A SSI	B REPL FACTOR	REF NUMBER & MFR CODE		U/M		
87		XBOZZ	XB	MDOZZ				PLATE, DESIGNATION 70-1341 30554	DGG	EA	1	
87		XBOZZ	XB	MDOZZ				PLATE, DIAGRAM 72-2935 30554	DGG	EA	1	
87		XBOZZ	XB	MDOZZ				PLATE, DIAGRAM 72-2934 30554	DGG	EA	1	
87		XBOZZ	BX	MDOZZ				PLATE, INSTRUCTION 72-2941-2 30554	DGG	EA	1	
87		XBOZZ	XB	MDOZZ				PLATE, DIAGRAM 72-2930 30554	DGG	EA	1	

(1) ILLUSTRATION A	(2) SMR CODE A	B	C	D	(3) A	B	(4) NATIONAL STOCK NUMBER	(5) DESCRIPTION REF NUMBER & MFR CODE	USABLE ON CODE	(6) U/M	(7) QTY INC IN UNITS	(8) USMC QTY PER EQUIP
GROUP 23-PARTS KITS												
73	PAFZZ	PAOZZ	PAHZZ	PAHZZ		.050	5330-00-401-5247	KIT, GASKET: FUEL PUMP 16369 84760		EA	1	1
67	12							GASKET, COVER		EA	1	
65	10							SEAL, SHAFT		EA	1	
68	11							WASHER		EA	1	
69	3							SEAL, END PLATE		EA	1	
69	5							SEAL, ELEMENT		EA	1	
69	6							RING		EA	1	
69	11							SEAL, CAP		EA	1	
69	19							SEAL		EA	1	
70	2							SEAL, SHAFT		EA	1	
70	15							SEAL, GUIDE		EA	1	
71	12							SEAL, RING		EA	1	
71	15							SEAL, SCREW		EA	1	
71	18							RING		EA	2	
72	11							SEAL, HEAD		EA	1	
72	23							WASHER		EA	1	
73	3							WASHER		EA	1	
73	8							GASKET		EA	1	
73	13							SEAL, PILOT TUBE		EA	1	
73	14							SEAL, DRIVE SHAFT		EA	1	
74	PAFZZ	PAOZZ	PAHZZ	PAHZZ		.050	2930-00-678-3818	KIT, REPAIR: WATER PUMP 255368CS 28265		EA	1	
74	10							GASKET: PIPE MTG		EA	1	
74	18							GASKET		EA	1	
74	22							GASKET, COVER		EA	1	
74	23							RING, SNAP		EA	1	
74	24							SHAFT		EA	1	
74	25							IMPELLER		EA	1	
74	26							SEAL		EA	1	
83	PAFZZ	PAOZZ	PAHZZ	PAHZZ		.050	5330-01-022-7996	KIT, GASKET: VALVE GRINDING 40-3094661A 28265		EA	1	1
74	10							GASKET		EA	1	

(1) ILLUSTRATION		(2) SMR CODE				(3)		(4)	(5)	(6)	(7)	(8)
A	B	A	B	C	D	A	B	NATIONAL STOCK NUMBER	DESCRIPTION	USABLE ON CODE	QTY INC IN UNITS	USMC QTY PER EQUIP
FIG. NO.	ITEM NO.	ARMY	AIR FORCE	NAVY	USMC	SSI	REPL FACTOR		REF NUMBER & MFR CODE	U/M		
74	18								GASKET	EA	1	
74	8								GASKET	EA	3	
76	4								GASKET, INTAKE MANIFOLD	EA	1	
76	9								GASKET, EXHAUST MANIFOLD	EA	6	
77	5								WASHER	EA	3	
77	7								GASKET, CYLINDER HEAD COVER	EA	1	
77	30								SEAL, STEM	EA	6	
77	41								GASKET, CYLINDER HEAD	EA	1	
80	12								GASKET	EA	1	
79		PAHZZ	PAQZZ	PAGZZ	PAHZZ		.050	5330-01-022-7995	KIT, GASKET: ENGINE OVERHAUL 40-3094662A 28265	EA	1	1
61	15								GASKET, COVER	EA	1	
74	10								GASKET	EA	1	
74	18								GASKET	EA	1	
75	8								GASKET	EA	2	
76	4								GASKET, INTAKE MANIFOLD	EA	4	
76	9								GASKET, EXHAUST MANIFOLD	EA	6	
79	4								GASKET	EA	3	
77	7								GASKET, CYLINDER HEAD COVER	EA	1	
77	30								SEAL, STEM	EA	6	
77	41								GASKET, CYLINDER HEAD	EA	1	
78	5								GASKET	EA	2	
78	6								SEAL	EA	2	
78	11								SEAL	EA	1	
78	12								GASKET	EA	4	
80	9								GASKET	EA	1	
80	10								SEAL	EA	1	
80	12								GASKET	EA	4	
83	4								GASKET	EA	1	
81		PAHZZ	PAQZZ	PDGZZ	PAHZZ		.050	2815-00-133-0816	SET, RING: PISTON 291168AS 28265	EA	6	6
81	9								RING	EA	6	
81	10								RING	EA	6	
81	11								RING	EA	6	
81	2								RING	EA	6	

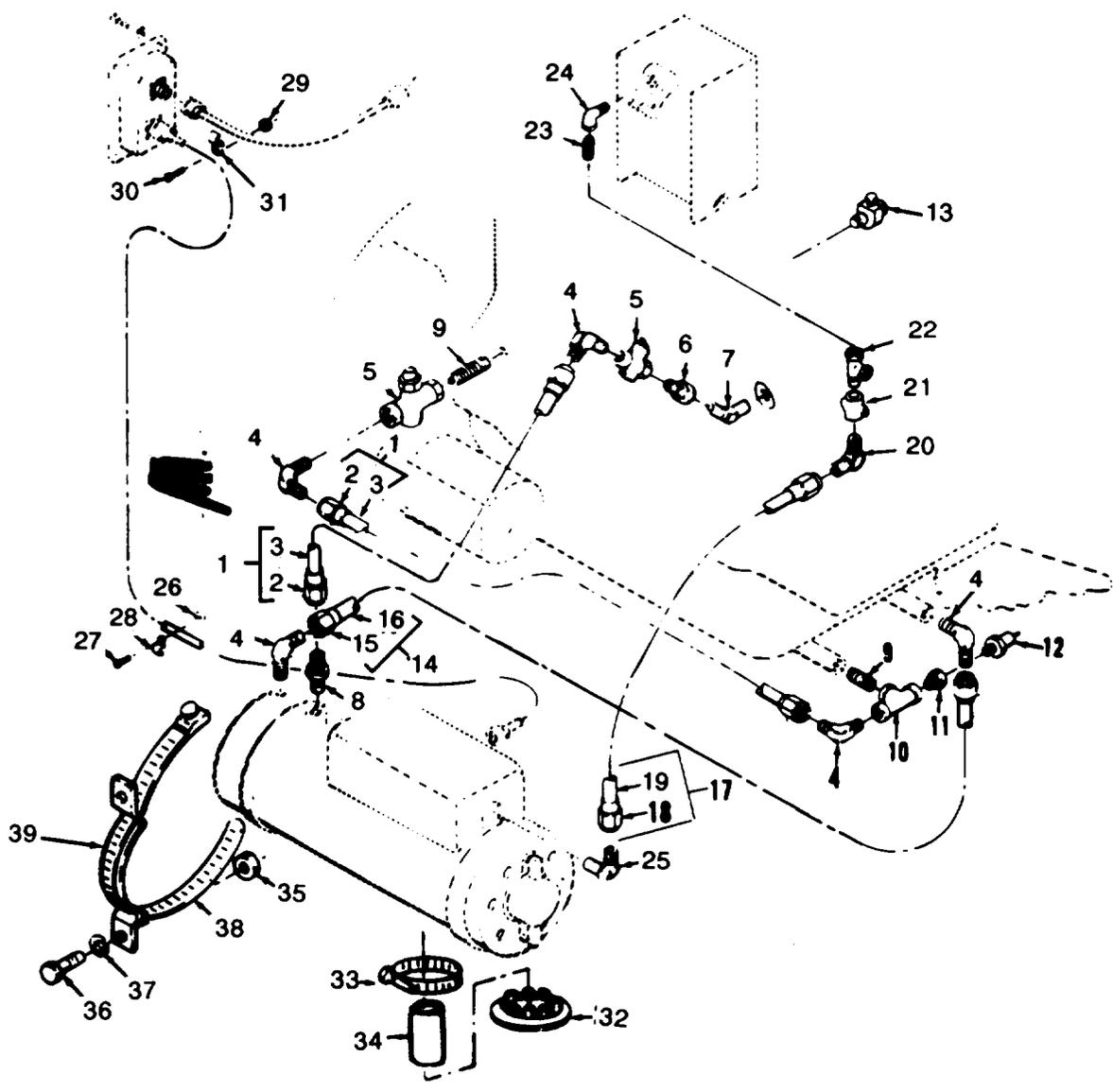

Figure 88. Fuel burning winterization kit.

(1) ILLUSTRATION A FIG. NO.	(2) SMR CODE B ITEM NO.	A	B AIR FORCE	C	D	(3)		(4) NATIONAL STOCK NUMBER	(5) DESCRIPTION REF NUMBER & MFR CODE	USABLE ON CODE	(6) U/M	(7) QTY INC IN UNITS	(8) USMC QTY PER EQUIP
						A	B REPL FACTOR						
GROUP 25-WINTERIZATION KIT													
88		PAOFF	PAOZZ	PBGGG	PAOFF			6115-00-463-9083	WINTERIZATION KIT, FUEL, BURNING 72-2837 30554 MEF005AWF 36024		EA	1	
88	1	XBOZZ	PAOZZ	AGGZZ	AFOZZ				HOSE ASSEMBLY MS28741-8-0344 96906		EA	1	
88	2	PAOZZ	PAOZZ	PAGZZ	PAFZZ			4730-00-842-2202	FITTING MS24587-8 96906		EA	4	
88	3	PAOZZ	PAOZZ	PAGZZ	PAFZZ			4720-00-542-4433	HOSE, RUBBER MILH87948 81349		FT	V	
88	4	PAOZZ	PAOZZ	XBGZZ	PAOZZ			4730-00-437-0040	ELBOW: 90 DEG 70-1109-13 30554 8-8CTX-B 30780		EA	5	
88	5	PAOZZ	PAOZZ	PAGZZ	PAOZZ			4820-00-136-1085	COCK, SHUTOFF: WATER 69-659 30554 A400-3 16024		EA	5	
88	6	PAOZZ	PAOZZ	XBGZZ	PAOZZ			4730-00-006-3977	COUPLING, PIPE C3069X8X6 79470		EA	2	
88	7	PAOZZ	PAOZZ	XBGZZ	PAOZZ			4730-00-580-6406	ELBOW 72-2167 30554 3-8CD45B 45681		EA	1	
88	8	PAOZZ	PAOZZ	XBGZZ	PAOZZ			4730-00-141-1094	NIPPLE, HEXAGON: HEATER 216P8 30780		EA	1	
88	9	XBOZZ	PAOZZ	XBGZZ	XBOZZ				NIPPLE, PIPE 72-2173-2 30554 215PN8 30780		EA	2	
88	10	PAOZZ	PAOZZ	XBGZZ	PAOZZ			4730-00-982-8853	TEE, BRANCH 72-2170 30554 1-2MMOB 30780		EA	1	
88	11	PAOZZ	PAOZZ	XBGZZ	PAOZZ			3120-00-472-8343	BUSHING, PIPE 70-1494-6 30554 209P8-4 93061		EA	1	
88	12	PAOZZ	PAOZZ	PAGZZ	PAOZZ			4820-00-934-7877	VALVE, RELIEF 70-1498 30554 16-004-013 43990		EA	1	
88	13	PAFZZ	PAOZZ	PAGZZ	PAOZZ			5930-01-043-6966	SWITCH, THERMOSTATIC 70-1592-2 30554 5100-11-198 82415		EA	1	
88	14	MFOZZ	PAOZZ	AGGZZ	MFOZZ				HOSE, ASSEMBLY MS28741-8-0320 96906 MANUFACTURE FROM:		EA	2	
88	15	PAOZZ	PAOZZ	PAGZZ	PAGZZ			4730-00-842-2202	FITTING, HOSE MS24587-8 96906		EA	2	
88	16	PAOZZ	PAOZZ	PAGZZ	PAFZZ			4720-00-542-4433	HOSE, RUBBER MILH8794-8 81349		FT	V	
88	17	MFOZZ	PAOZZ	AGGZZ	MFOZZ			4720-00-450-6618	HOSE ASSEMBLY MS28741-5-0580 96906 MANUFACTURE FROM:		EA	1	

(1) ILLUSTRATION A	(2) SMR CODE A	(3) A	(4) NATIONAL STOCK NUMBER	(5) DESCRIPTION	(6) USABLE ON CODE	(7) QTY INC IN UNITS	(8) USMC QTY PER EQUIP				
								B	C	D	B
FIG. NO.	ITEM NO.	ARMY	AIR FORCE	NAVY	USMC	SSI	B REPL FACTOR	REF NUMBER & MFR CODE	U/M	U/M	U/M
88	18	PAOZZ	PAOZZ	PAGZZ	PAFZZ			4730-00-842-2201 FITTING MS24587-5 96906	EA		2
88	19	PAOZZ	PAOZZ	PAGZZ	PAFZZ			4720-00-289-9197 HOSE, RUBBER MILH8794-5 81349	FT		V
88	20	PAOZZ	PAOZZ	XBGZZ	PAOZZ			4730-00-292-2311 ELBOW 70-1500 30554 5-4D5XS 08762	EA		1
88	21	PAOZZ	PAOZZ	XBGZZ	PAOZZ			4820-00-277-1765 COCK, SHUTOFF: FUEL MS35930-2 96906	EA		1
88	22	PAOZZ	PAOZZ	XBGZZ	PAOZZ			4730-00-177-6166 TEE, STREET 72-2172 30554	EA		1
88	23	PAOZZ	PAOZZ	XBGZZ	PAOZZ			4730-00-222-1837 NIPPLE, CLOSE 72-2173-1 30554 215FN4 30780	EA		1
88	24	XBOZZ	XB	XBGZZ	XBOZZ			ELBOW, STREET 70-1495-4 30554 1202P5-4-4 93061	EA		1
88	25	PAOZZ	PAOZZ	XBGZZ	PAOZZ			4730-00-294-1508 ELBOW, PIPE TO TUBE 70-1528 30554 5CCTXS 30780	EA		1
88	26	PAOZZ	PAOZZ	PAGZZ	PAOZZ			5310-00-934-9751 NUT, PLAIN, HEXAGON MS35690-302 96906	EA		4
88	27	PAOZZ	PAOZZ	PAGZZ	PAOZZ			5305-00-191-6226 SCREW, WASHER F15121-64 45722	EA		4
88	28	PAOZZ	PAOZZ	XBGZZ	PAOZZ			5340-00-057-2094 CLAMP, LOOP MS21333-71 96906	EA		3
88	29	PAOZZ	PAOZZ	XBGZZ	PAOZZ			5310-00-934-9751 NUT, PLAIN, HEXAGON: CLAMP MTG MS35690-302 96906	EA		1
88	30	PAOZZ	PAOZZ	XBGZZ	PAOZZ			5305-00-191-6226 SCREW, WASHER: CLAMP MTG F15121-64 45722 69-662-64 30554	EA		3
88	31	PAOZZ	PAOZZ	XBGZZ	PAOZZ			5340-00-922-6300 CLAMP, LOOP MS21333-77 96906	EA		1
88	32	XBOZZ	XB	XBGZZ	XBOZZ			CAP, EXHAUST TUBE: HEATER 72-2873 30554	EA		1
88	33	PAOZZ	PAOZZ	XBGZZ	PAOZZ			4730-00-908-3193 CLAMP, HOSE: EXHAUST TUBE MS35842-12 96906	EA		1
88	34	XBOZZ	XB	XBGZZ	XBOZZ			TUBE, EXHAUST: HEATER 70-1434 30554	EA		1
88	35	PAOZZ	PAOZZ	XBGZZ	PAOZZ			5310-00-761-6822 NUT, PLAIN, HEXAGON: HEATER MTG MS51967-2 96906	EA		4
88	36	PAOZZ	PAOZZ	XBGZZ	PAOZZ			5305-00-068-0502 SCREW, CAP HEATER MTG MS90725-6 96906	EA		4
88	37	PAOZZ	PAOZZ	XBGZZ	PAOZZ			5310-00-584-5272 WASHER, LOCK: HEATER MTG MS35338-44 96906	EA		4
88	38	XBOZZ	XB	XBGZZ	XBOZZ			CLAMP: HEATER MTG MS35842-16 96906	EA		2
88	39							BRACKET, HEATER MTG C85-2005 30554	EA		2

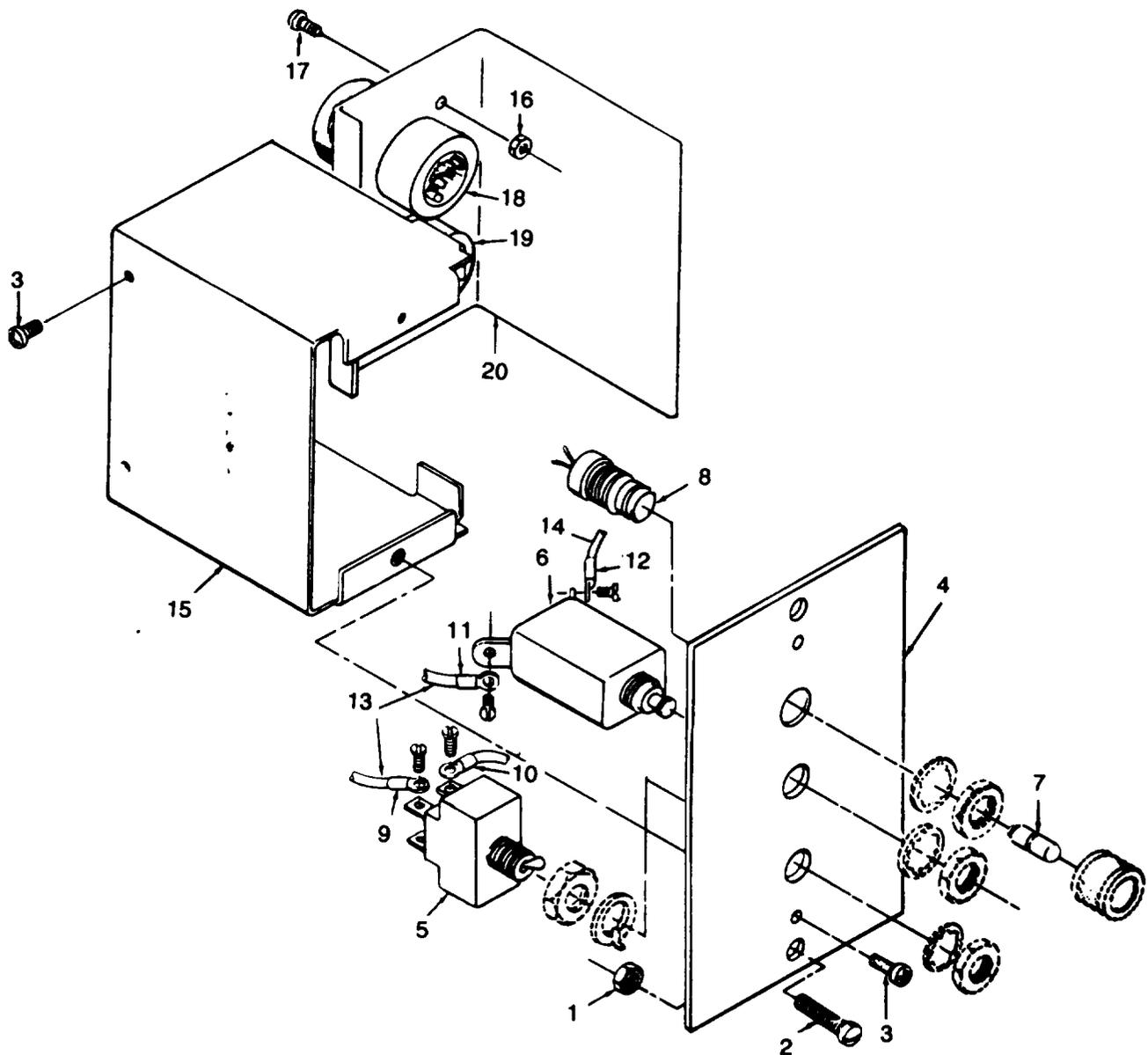

Figure 89. Engine heater control box.

(1) ILLUSTRATION A FIG. NO.	(2) SMR CODE B ITEM NO.	(3)				(4) NATIONAL STOCK NUMBER	(5) DESCRIPTION REF NUMBER & MFR CODE	(6) USABLE ON CODE U/M	(7) QTY INC IN UNITS	(8) USMC QTY PER EQUIP
		A ARMY	B AIR FORCE	C NAVY	D USMC					
89	1	PAOZZ	PAOZZ	PAGZZ	PAFZZ	5310-00-934-9751	NUT, PLAIN, HEXAGON: CONTROL BOX MTG MS35650-302 96906	EA	2	
89	2	PAOZZ	PAOZZ	PAGZZ	PAFZZ	5305-00-191-6116	SCREW, WASHER: CONTROL BOX MTG 69-662-64 30554	EA	2	
89		XBOZZ	XC	AGGGG	AFZZ		BOX ASSEMBLY, CONTROL: HEATER 69-650 30554 30554-69-650 36024	EA	1	
89	3	PAOZZ	PAOZZ	XBGZZ	PAFZZ	5305-00-211-9344	SCREW, WASHER 69-662-17 30554 P15121-17 45722	EA	4	
89	4	XBOZZ	MOO	XBGZZ	XBZZ		PLATE, FACE 69-654 30554 30554-69-654	EA	1	
89	5	PAOZZ	PAOZZ	PAGZZ	PAFZZ	5390-00-655-1575	SWITCH, TOGGLE MS35059-22 96906	EA	1	
89	6	PAOZZ	PAOZZ	PAGZZ	PAFZZ	5925-00-686-3301	CIRCUIT BREAKER MS25244-15 96906	EA	1	
89	7	PAOZZ	PAOZZ	PAOZZ	PAOZZ	6240-00-155-8714	LAMP, INCANDESCENT MS25231-313 96906	EA	1	
89	8	PAOZZ	PAOZZ	PAGZZ	PAFZZ	6210-00-638-5088	LIGHT, INDICATOR MS25331-4 96906	EA	1	
89	9	PAOZZ	PAOZZ	PAGZZ	PAFZZ	5940-00-283-5280	TERMINAL, LUG MS25036-106 96906	EA	3	
89	10	PAOZZ	PAOZZ	PAGZZ	PAFZZ	5940-00-204-8990	TERMINAL, LUG MS25036-111 96906	EA	1	
89	11	PAOZZ	PAOZZ	PAGZZ	PAFZZ	5940-00-143-4774	TERMINAL, LUG MS25036-153 96906	EA	2	
89	12	PAOZZ	PAOZZ	PAGZZ	PAFZZ	5940-00-143-4775	TERMINAL, LUG MS25036-156 96906	EA	2	
89	13	PAOZZ	PAOZZ	PAGZZ	PAFZZ	6145-00-578-7514	WIRE, ELECTRICAL M5086-2-12-9 81349	FT	V	
89	14	PAOZZ	PAOZZ	PAGZZ	PAFZZ	6145-00-578-6605	WIRE, ELECTRICAL M5086-2-16-9 81349	FT	V	
89	15	XBOZZ	MOO	XBGZZ	XBZZ		COVER, BOX 69-656 30554 30554-69-656 36024	EA	1	
89	16	PAOZZ	PAOZZ	XBGZZ	PAFZZ	5310-00-063-7415	NUT, WASHER ASSEMBLY: CONNECTOR MTG 69-561-1 30554 511-041800-00 78189	EA	8	
89	17	PAOZZ	PAOZZ	XBGZZ	PAFZZ	5305-00-043-6642	SCREW, MACHINE: CONNECTOR MTG MS35225-17 96906	EA	8	
89	18	PAOZZ	PAOZZ	PAGZZ	PAFZZ	5935-00-852-9611	CONNECTOR, RECEPTACLE MS3102R18-11P 96906	EA	1	
89	19	PAOZZ	PAOZZ	PAGZZ	PAFZZ	5935-00-842-6316	CONNECTOR, RECEPTACLE MS3102R18-11 96906	EA	1	
89	20	XBOZZ	MOO	XBGZZ	XBZZ		FRAME, CONTROL BOX 580544 30554 30554-69-655 36024	EA	1	

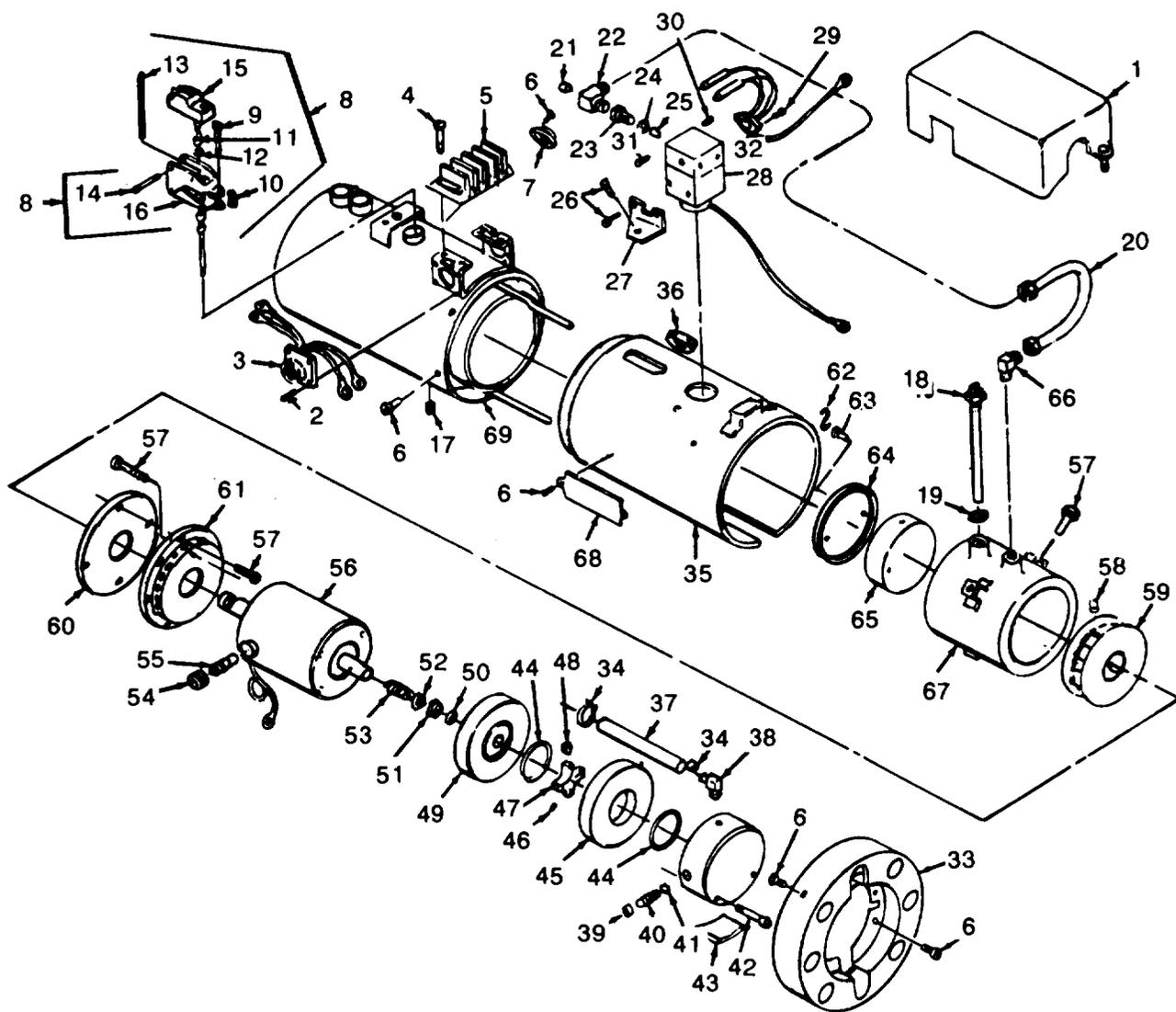

Figure 90. Engine heater.

(1) ILLUSTRATION		(2) SMR CODE				(3)		(4) NATIONAL STOCK NUMBER	(5) DESCRIPTION	(6) USABLE ON CODE	(7) QTY INC IN UNITS	(8) USMC QTY PER EQUIP
A FIG. NO.	B ITEM NO.	A ARMY	B AIR FORCE	C NAVY	D USMC	A SSI	B REPL FACTOR	REF NUMBER & MFR CODE	U/M			
90		PAFFF	PAOFF	PAGZZ	PAOFF			2990-00-135-6427 HEATER, ENGINE 69-775 30554	EA	1		
90	1	XBFZZ	XB	XBGZZ	PAFZZ			2990-00-477-6153 COVER, PROTECTIVE B2794 80684	EA	1		
90	2	PAFZZ	PAOZZ	XBGZZ	PAFZZ			5305-00-253-3437 SCREW, ASSEMBLED WASHER: RECEPTACLE MTG A2172 80684	EA	4		
90	3	PAFZZ	PAOZZ	PAGZZ	PAFZZ			5935-00-106-3713 RECEPTACLE ASSEMBLY A2796 80684	EA	1		
90	4	PAFZZ	PAOZZ	XBGZZ	PAFZZ			5305-00-721-4529 SCREW, ASSEMBLED WASHER: BLOCK MTG A2173 80684	EA	4		
90	5	XBFZZ	XB	XBGZZ	PAFZZ			5940-00-420-5240 BLOCK, TERMINAL A2015 80684	EA	1		
90	6	PAFZZ	PAOZZ	XBGZZ	PAFZZ			5305-00-410-3007 SCREW, ASSEMBLED WASHER: SWITCH MTG A2841 80684	EA	17		
90	7	PAFZZ	PAOZZ	PAGZZ	PAFZZ			5930-00-854-8344 SWITCH, LIMIT A2322 80684	EA	1		
90	8	PAFZZ	AFO	AGGGG	PAFZZ			5930-00-532-0777 SWITCH ASSEMBLY, FLAME B2070 80684	EA	1		
90	9	PAFZZ	PAOZZ	XBGZZ	PAFZZ			5305-00-119-4728 SCREW, MACHINE A2137 80684	EA	1		
90	10	PAFZZ	PAOZZ	PAGZZ	PAFZZ			5360-00-859-5923 SPRING, MACHINE A2091 80684	EA	1		
90	11	PAFZZ	PAOZZ	PAGZZ	PAFZZ			5360-00-859-5922 SPRING, TENSION A2090 80684	EA	1		
90	12	XBFZZ	XB	XBGZZ	PAFZZ			2990-00-014-5626 PAD, SPRING A2013 80684	EA	1		
90	13	PAFZZ	PAOZZ	PAGZZ	PAFZZ			5990-00-701-6934 ROD, QUARTZ A2010 80684	EA	1		
90	14	PAFZZ	PAOZZ	XBGZZ	PAFZZ			5305-00-276-8782 SCREW, SWITCH A2238 80684	EA	2		
90	15	PAFZZ	PAOZZ	PAGZZ	PAFZZ			5930-00-708-3588 SWITCH A2092 80684	EA	1		
90	16	XBFZZ	XB	XBGZZ	PAFZZ			4520-00-014-5627 FRAME ASSEMBLY B2117 80684	EA	1		
90	17	XBFZZ	XB	XBGZZ	XBFZZ			PLUG, DRAIN A2393 80684	EA	1		
90	18	PAFZZ	PAOZZ	PAGZZ	PAFZZ			2540-00-122-2098 IGNITER A2757 80684	EA	1		
90	19	PAFZZ	PAOZZ	PAGZZ	PAFZZ			5330-00-119-4732 GASKET, IGNITER A2096 80684	EA	1		
90	20	PAFZZ	PAOZZ	XBGZZ	PAFZZ			4710-00-457-7018 TUBE ASSEMBLY, FUEL A2837 80684	EA	1		
90		PAFZZ	PAOZZ	PAGZZ	PAFZZ			4820-00-072-0567 VALVE ASSEMBLY B2795 80684	EA	1		

(1) ILLUSTRATION		(2) SMR CODE				(3)		(4) NATIONAL STOCK NUMBER		(5) DESCRIPTION	(6) USABLE ON CODE	(7) QTY INC IN UNITS	(8) USMC QTY PER EQUIP
A FIG. NO.	B ITEM NO.	A ARMY	B AIR FORCE	C NAVY	D USMC	A SSI	B REPL FACTOR		REF NUMBER & MFR CODE	U/M			
90	21	XBFZZ	XB	XBGZZ		XBFZZ			PLUG, ORIFICE A2154 80634	EA	1		
90	22	PAFZZ	PAOZZ	XBGZZ		PAFZZ		2540-00-122-2096	ORIFICE ASSEMBLY A2602 80684	EA	1		
90	23	XBFZZ	XB	XBGZZ		PAFZZ		2910-00-454-0668	BODY, FILTER A2603 80684	EA	1		
90	24	PAFZZ	PAOZZ	PAGZZ		PAFZZ		5365-00-122-2795	GASKET, BODY A2605 80684	EA	1		
90	25	PAFZZ	PAOZZ	PAGZZ		PAFZZ		2910-00-454-0666	FILTER, SINTERED A2604 80684	EA	1		
90	26	PAFZZ	PAOZZ	XBGZZ		PAFZZ		5305-00-927-0107	SCREW, ASSEMBLED WASHER A2170 80634	EA	6		
90	27	XBFZZ	XB	XBGZZ		PAFZZ		5340-00-014-5623	BRACKET, VALVE B2055 80684	EA	2		
90	28	XBFZZ	XB	XAGZZ		XBFZZ			VALVE, REGULATOR B2940 80684	EA	1		
90	29	PAFZZ	PAOZZ	XBGZZ		PAFZZ		5305-00-253-3437	SCREW, ASSEMBLED WASHER A2172 80684	EA	2		
90	30	XBFZZ	XB	XBGZZ		XBFZZ			SETSCREW A2847 80684	EA	1		
90	31	PAFZZ	PAOZZ	XBGZZ		PAFZZ		5305-00-155-5145	SETSCREW A2204 80684	EA	1		
90	32	XBFZZ	XB	PAGZZ		XBFZZ			PRE-HEATER ASSEMBLY A2684 80684	EA	1		
90	33	XBFZZ	XB	XBGZZ		PAFZZ		4210-00-138-2249	COVER, AIR INLET B2859 80684	EA	1		
90	34	XBFZZ	XB	PAGZZ		XBFZZ			CLAMP, HOSE A2823 80684	EA	4		
90	35	XBFZZ	XB	XBGZZ		PAFZZ		4210-00-138-2250	CASING, BURNER C2797 80684	EA	1		
90	36	PAFZZ	PAOZZ	XBGZZ		PAFZZ		5325-00-889-1271	GROMMET, CASING A2141 80684	EA	1		
90	37	PAFZZ	PAOZZ	PAGZZ		PAFZZ		4720-00-139-4105	HOSE A2829 80684	EA	2		
90	38	XBFZZ	XB	XBGZZ		XBFZZ			ELBOW A2889 80684	EA	2		
90		PAFFF	PAOFF	XBGZZ		PAFFF		2930-00-052-3545	MOTOR, PUMP ASSEMBLY B2856 80684	EA	1		
90		XAFFF	XA	XBGZZ		XAFFF			PUMP ASSEMBLY B2894 80684	EA	1		
90	39	XBFZZ	XB	XBGZZ		XBFZZ			PLUG A2895 80684	EA	1		
90	40	PAFZZ	PAOZZ	PAGZZ		PAFZZ		5360-00-221-6558	SPRING, VALVE A2896 80684	EA	1		
90	41	XBFZZ	XB	XBGZZ		XBFZZ			BALL, BEARING A2903 80684	EA	1		

(1) ILLUSTRATION A	(1) FIG. NO.	(2) SMR CODE A	(2) B	(2) C	(2) D	(3) A	(3) B	(4) NATIONAL STOCK NUMBER	(5) DESCRIPTION REF NUMBER & MFR CODE	(6) USABLE ON CODE	(6) U/M	(7) QTY INC IN UNITS	(8) USMC QTY PER EQUIP
	90	42	XBFZZ	XB	XBGZZ	XBFZZ			SCREW A2897 80684		EA	1	
	90	43	XBFZZ	XB	XBGZZ	PAFZZ		4210-00-138-2254	PLATE, PORT B2929 80684		EA	1	
	90	44	PAFZZ	PAOZZ	PAGZZ	PAFZZ		5330-00-462-4524	O-RING A2932 80684		EA	2	
	90	45	XBFZZ	XB	XBFZZ	XBFZZ			RING, CAM A2898-1 80684		EA	1	
	90	46	PAFZZ	PAOZZ	XBGZZ	PAFZZ		5305-00-824-1643	SETSCREW A2902 80684		EA	1	
	90	47	PAFZZ	PAOZZ	XBGZZ	PAFZZ		2540-00-122-2059	ROTOR A2900 80684		EA	1	
	90	48	XBFZZ	XB	XBGZZ	PAFZZ		2540-00-122-2111	BLADE A2901 80684		EA	4	
	90	49	XBFZZ	XB	XBGZZ	XBFZZ			ADAPTER A2928 80684		EA	1	
	90		PAFZZ	PAOZZ	PAGZZ	PAFZZ		5330-00-461-5732	SEAL ASSEMBLY A2904 80684		EA	1	
	90	50	PAFZZ	PAOZZ	PAGZZ	PAFZZ		5330-00-145-5030	O-RING A2899 80684		EA	1	
	90	51	XAFZZ	XA	XBGZZ	XBFZZ			CAGE, SEAL A2905 80684		EA	1	
	90	52	PAFZZ	PAOZZ	PAGZZ	PAFZZ		5310-00-486-2519	WASHER, FLAT: SEAL A2931 80684		EA	1	
	90	53	PAFZZ	PAOZZ	PAGZZ	PAFZZ		5360-00-485-0715	SPRING, SEAL A2930 80684		EA	1	
	90	54	PAFZZ	PAOZZ	PAGZZ	PAFZZ		5977-00-456-6097	CAP, BRUSH A2480 80684		EA	2	
	90	55	PAFZZ	PAOZZ	PAGZZ	PAGZZ		5977-00-078-9102	BRUSH: SPRING A2481 80684		EA	2	
	90	56	XAFZZ	XA	XBGZZ	XAFZZ			MOTOR ASSEMBLY B2798 80684		EA	1	
	90	57	PAFZZ	PAOZZ	XBGZZ	PAFZZ		5305-00-436-7317	SCREW, ASSEMBLED WASHER A2822 80684		EA	9	
	90	58	XBFZZ	XB	XBGZZ	XBFZZ			SETSCREW A2657 80684		EA	1	
	90	59	XBFZZ	XB	XBGZZ	XBFZZ			FAN, COMBUSTION A2615 80684		EA	1	
	90	60	XBFZZ	XB	XBGZZ	XBFZZ		4210-00-138-2252	PLATE, INLET A2631 80684		EA	1	
	90	61	XBFZZ	XB	XBGZZ	PAFZZ		4210-00-138-2253	INLET, AIR 82283 80684		EA	1	
	90	62	XBFZZ	XB	XBGZZ	XBFZZ			LOCKWIRE A2862 80684		EA	V	
	90	63	XBFZZ	XB	XBGZZ	XBFZZ			SCREW A2791 80684		EA	2	

TM9-6115-465-24P
 TO35CZ-3-446-4
 NAVFAC P-8-625-24P
 SL-4-06858B/06859D

(1) ILLUSTRATION		(2) SMR CODE				(3)		(4) NATIONAL STOCK NUMBER	(5) DESCRIPTION	USABLE ON CODE	(6) U/M	(7) QTY INC IN UNITS	(8) USMC QTY PER EQUIP
A FIG. NO.	B ITEM NO.	A ARMY	B AIR FORCE	C NAVY	D USMC	A SSI	B REPL FACTOR	REF NUMBER & MFR CODE					
90	64	PAFZZ	PAOZZ	XBGZZ	PAFZZ			2990-00-477-6143	RETAINER A2612 80684		EA	1	
90	65	XBFZZ	XB	XBGZZ	PAFZZ			2540-00-454-0665	VAPORIZOR A2610 80684		EA	1	
90	66	PAFZZ	PAOZZ	XBGZZ	PAFZZ			4730-00-436-7317	ELBOW A2828 80684		EA	1	
90	67	XBFZZ	XB	XBGZZ	PAFZZ			4210-00-138-2251	BURNER ASSEMBLY C2583 80684		EA	1	
90	68	XBOZZ	XB	XBOZZ	MDOZZ				NAMEPLATE A2714 80684		EA	1	
90	69	PAFZZ	PAOZZ	XBGZZ	PAFZZ			2990-00-161-7700	EXCHANGE, HEAT C2691 80684		EA	1	

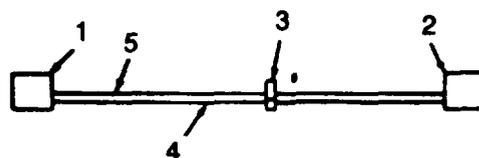

Figure 91. Fuel Burning winterization kit wiring harness

TM9-6115-465-24P
 TO35CZ-3-446-4
 NAVFAC P-8-625-24P
 SL-4-06858B/06859D

(1) ILLUSTRATION		(2) SMR CODE				(3)		(4) NATIONAL STOCK NUMBER	(5) DESCRIPTION	(6) USABLE ON CODE	(7) QTY INC IN UNITS	(8) USMC QTY PER EQUIP
A FIG. NO.	B ITEM NO.	A ARMY	B AIR FORCE	C NAVY	D USMC	A SSI	B REPL FACTOR	REF NUMBER & MFR CODE	U/M			
91		MFOZZ	PAOZZ	AGGZZ	AFFZZ			WIRING HARNESS 72-2856 30554 30554-72-2856 36024 MANUFACTURE FROM:	EA	1		
91	1	PAOZZ	PAOZZ	PAGZZ	PAFZZ			5935-00-879-3265 CONNECTOR MS3106R18-11P 96906	EA	1		
91	2	PAOZZ	PAOZZ	PAGZZ	PAFZZ			5934-00-725-4153 CONNECTOR MS3106R18-11S 96906	EA	1		
91	3	PAOZZ	PAOZZ	XBGZZ	PAFZZ			5975-00-727-5153 STRAP, CABLE MS3367-4-9 96906	EA	V		
91	4	PAOZZ	PAOZZ	PAGZZ	PAFZZ			6145-00-578-6605 WIRE, ELECTRICAL MS086-2-16-9 81349	FT	V		
91	5	PAOZZ	PAOZZ	PAGZZ	PAFZZ			6145-00-578-7514 WIRE, ELECTRICAL MS086-2-12-9 81349	FT	V		

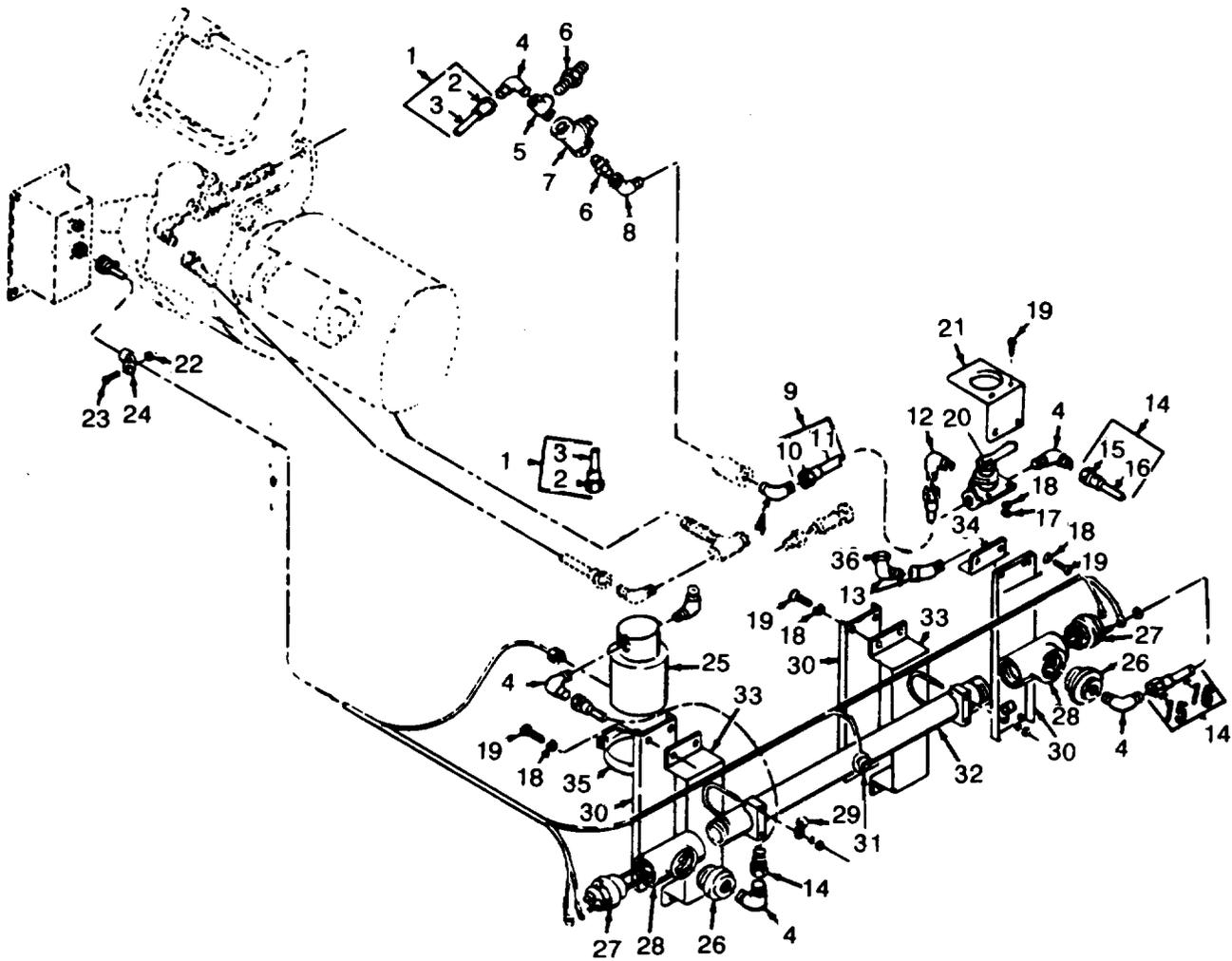

Figure 92. Electric winterization kit.

(1) ILLUSTRATION		(2) SMR CODE				(3)		(4) NATIONAL STOCK NUMBER	(5) DESCRIPTION	(6) USABLE ON CODE	(7) QTY INC IN UNITS	(8) USMC QTY PER EQUIP
A FIG. NO.	B ITEM NO.	A ARMY	B AIR FORCE	C NAVY	D USMC	A SSI	B REPL FACTOR	REF NUMBER & MFR CODE	U/M			
GROUP 26 - ELECTRIC WINTERIZATION KIT												
92		PAOFF	PAOFF	XBGGG	PAOFF			6115-00-463-9085	WINTERIZATION KIT, ELECTRICAL 72-2836 30554 30554-72-2836 36024	EA	1	
92	1	MOOZZ	XB	AGZZ	AFOZZ				HOSE ASSEMBLY, WATER MS28741-8-0320 96906 MANUFACTURE FROM:	EA	1	
92	2	PAOZZ	PAFZZ	PAGZZ	PAFZZ				FITTING MS24587-8 96906	EA	2	
92	3	PAOZZ	PAFZZ	PAGZZ	PAFZZ				HOSE, RUBBER MILH8794-8 81349	FT	V	
92	4	PAOZZ	PAFZZ	XBGZZ	PAOZZ	0	0	4730-00-437-0040	ELBOW, PIPE 70-1109-13 30554 8-8CTXB 45681	EA	10	
92	5	PAOZZ	PAFZZ	XBGZZ	PAOZZ			4730-00-294-1512	TEE, STREET 70-1489 30554 12MROB 45681	EA	1	
92	6	PAOZZ	PAFZZ	XBGZZ	PAOZZ			4730-00-288-9948	ADAPTER 70-1112-73 30554 8-8FTXS 45681	EA	2	
92	7	PAOZZ	PAFZZ	PAGZZ	PAOZZ			4820-00-136-1085	COCK, DRAIN 69-659 30554	EA	2	
92	8	XBOZZ	XB	XBGZZ	XBOZZ				ELBOW, STREET 72-2167 30554 3-8CD45B 30780	EA	1	
92	9	MOOZZ	AFB	AGZZ	AFOZZ			4720-00-203-2636	HOSE ASSEMBLY MS28741-9-0190 96906	EA	1	
92	10	PAOZZ	PAFZZ	PAGZZ	PAFZZ			4730-00-842-2202	FITTING MS24587-8 96906	EA	2	
92	11	PAOZZ	PAFZZ	PAGZZ	PAFZZ			4720-00-542-4433	HOSE, RUBBER MILH8794-8 81349	EA	V	
92	12	PAOZZ	PAFZZ	XBGZZ	PAOZZ			4730-00-331-4686	ELBOW, MALE 72-2168-1 30554 8-4CTXS 30780	EA	1	
92	13	PAOZZ	PAFZZ	XBGZZ	PAOZZ			4730-00-911-5707	ELBOW, STREET 72-2169 30554 1-4CD45S 30780	EA	2	
92	14	MOOZZ	AFB	AGZZ	AFOZZ			4720-00-838-7818	HOSE ASSEMBLY MS28741-8-0080 96906	EA	2	
92	15	PAOZZ	PAFZZ	PAGZZ	PAFZZ			4730-00-842-2202	FITTING MS24587-8 96906	EA	4	
92	16	PAOZZ	PAFZZ	PAGZZ	PAFZZ			4720-00-542-4433	HOSE, RUBBER MILH8794-8 81349	FT	V	
92	17	PAOZZ	PAFZZ	XBGZZ	PAOZZ			5310-00-761-6822	NUT, HEXAGON MS51967-2 96906	EA	2	
92	18	PAOZZ	PAFZZ	XBGZZ	PAOZZ			5310-00-582-5965	WASHER, LOCK: VALVE MTG MS35338-44 96906	EA	2	
92	19	PAOZZ	PAFZZ	XBGZZ	PAOZZ			5305-00-068-0502	SCREW, CAP, HEXAGON HEAD MS90725-6 96906	EA	14	

(1) ILLUSTRATION		(2) SMR CODE				(3)		(4) NATIONAL STOCK NUMBER		(5) DESCRIPTION	(6) USABLE ON CODE	(7) QTY INC IN UNITS	(8) USMC QTY PER EQUIP
A FIG. NO.	B ITEM NO.	A ARMY	B AIR FORCE	C NAVY	D USMC	A SSI	B REPL FACTOR		REF NUMBER & MFR CODE	U/M			
92	20	PAOZZ	PAOZZ	PAGZZ	PAOZZ			4820-00-491-3102	VALVE, THREE WAY 690774 30554 SP2201 70411	EA	1		
92	21	PAOZZ	MOO	XBGZZ	XBOZZ				BRACKET MTG 72-2857 30554 30554-72-2857 36024	EA	1		
92	22	PAOZZ	PAOZZ	XBGZZ	PAOZZ			5310-00-934-9751	NUT, HEXAGON MS35650-302 96906	EA	3		
92	23	PAOZZ	PAOZZ	XBGZZ	PAOZZ			5305-00-191-6226	SCREW, WASHER 69-662-64 30554 P15121-64 45722	EA	3		
92	24	PAOZZ	PAOZZ	XBGZZ	PAOZZ			5340-00-057-2904	CLAMP, LOOP MS21333-71 96906	EA	3		
92	25	PAOZZ	PAOZZ	XBGZZ	PAOZZ			4320-00-576-3557	PUMP, UNIT, WATER 72-2848 30554 30554-72-2848 36024	EA	1		
92	26	PAOZZ	PAOZZ	XBGZZ	PAOZZ			4730-01-019-4018	REDUCER 70-1492 30554	EA	2		
92	27	PAOZZ	PAOZZ	PAGZZ	PAOZZ			4540-00-282-8181	ELEMENT, HEAT 70-1397 30554 315-175-02 08599	EA	2		
92	28	PAOZZ	PAOZZ	XBGZZ	PAOZZ			4730-00-278-3988	TEE, PIPE AN917-10 88044	EA	2		
92	29	PAOZZ	PAOZZ	XBGZZ	PAOZZ			5340-00-067-3868	CLAMP, LOOP MS21333-109 96906	EA	2		
92	30	XBOZZ	MOO	XBGZZ	XBOZZ				BRACKET 72-2849 30554 30554-72-2849 36024	EA	2		
92	31	PAFZZ	PAOZZ	PAGZZ	PAOZZ			5930-00-329-6497	SWITCH, THERMOSTATIC 70-1592-1 30554 5100-011-099 82415	EA	1		
92	32	XBOZZ	MOO	XBGZZ	XBOZZ				PIPE 70-1416 30554 30554-70-1416 36024	EA	1		
92	33	XBOZZ	MOO	XBGZZ	XBOZZ				BRACKET MOUNTING 72-2861 30554 30554-72-2861 36024	EA	2		
92	34	XBOZZ	MOO	XBGZZ	XBOZZ				BRACKET 72-2860 30554 30554-72-2860 36024	EA	1		
92	35	PAOZZ	PAOZZ	PAGZZ	PAOZZ			4730-00-908-6292	CLAMP, HOSE MS35842-14 96906	EA	1		
92	36	XBOZZ	MOO	XBGZZ	XBOZZ				CAP, TUBE MS39321T8 96906	EA	1		

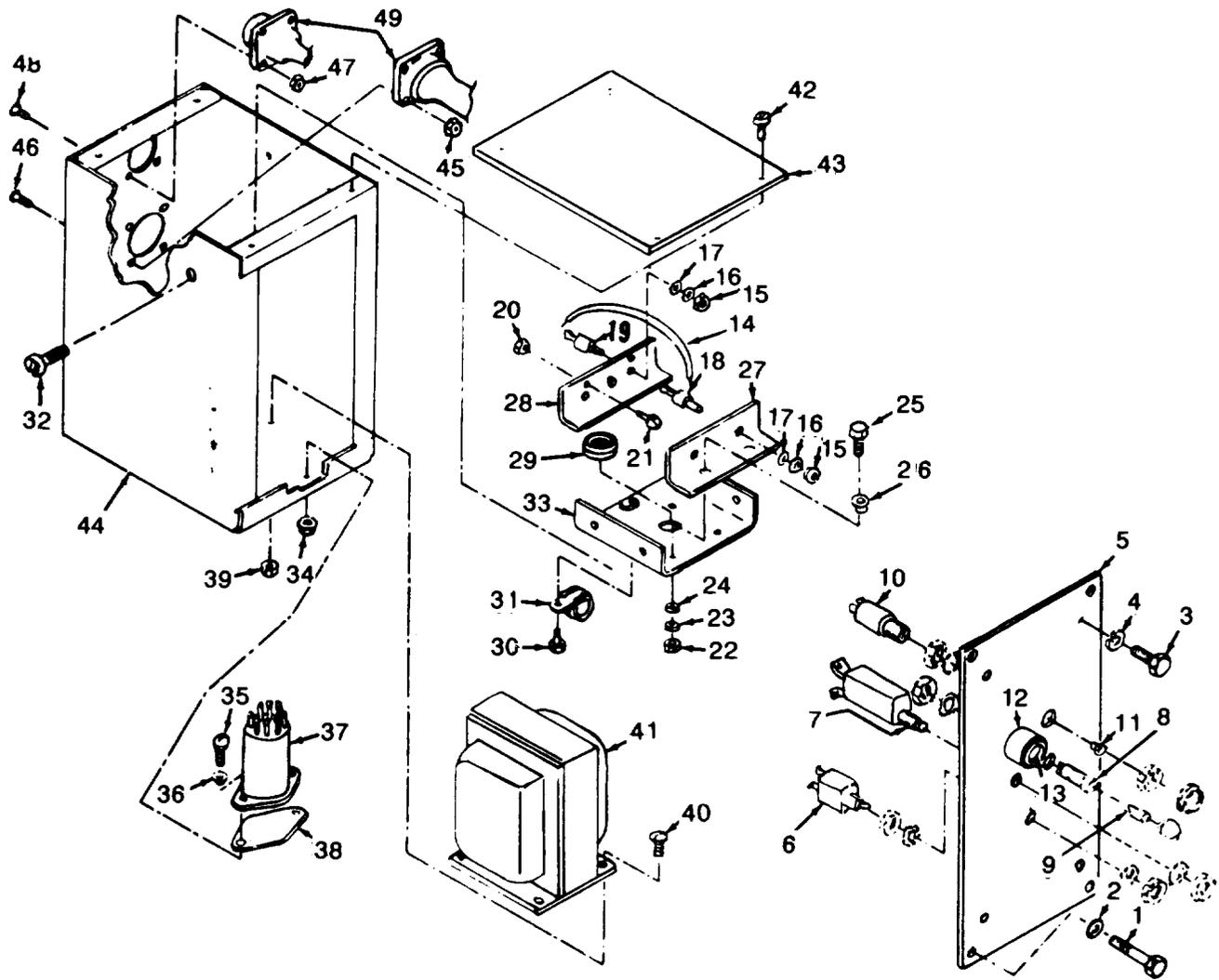

Figure 93. Electric heater control box.

(1) ILLUSTRATION A	(2) SMR CODE A	B	C	D	(3) A	B	(4) NATIONAL STOCK NUMBER	(5) DESCRIPTION	USABLE ON CODE	(6) U/M	(7) QTY INC IN UNITS	(8) USMC QTY PER EQUIP
93	1	PAFZZ	PAOZZ	PAGZZ	PAFZZ		5305-00-068-0500	SCREW, CAP, HEXAGON HEAD: CONTROL MS90725-3 96906		EA	4	
93	2	PAFZZ	PAOZZ	PAGZZ	PAFZZ		5310-00-582-5965	WASHER, LOCK: CONTROL BOX MTG MS35338-44 96906		EA	4	
93		XBFZZ	AFO	XBGGG	AFFZZ			CONTROL BOX: ELECTRICAL HEATER 70-1232 30554 30554-70-1232 36024		EA	1	
93	3	PAFZZ	PAZZZ	PAGZZ	PAFZZ		5305-00-068-0500	SCREW, CAP, HEXAGON HEAD: FRONT PANEL MTG MS90725-3 96906		EA	4	
93	4	PAFZZ	PAOZZ	PAGZZ	PAFZZ		5310-00-582-5965	WASHER, LOCK: FRONT PANEL MTG MS35338-44 96906		EA	4	
93	5	XBFZZ	XB	XBGZZ	XBFZZ			PANEL, FRONT 70-1229 30554 30554-70-1229 36024		EA	1	
93	6	PAFZZ	PAOZZ	PAGZZ	PAFZZ		5930-00-601-6342	SWITCH, TOGGLE 80-1614 30554 68240 31356		EA	1	
93	7	PAFZZ	PAOZZ	PAGZZ	PAFZZ		5925-00-682-4015	CIRCUIT BREAKER MS25244-20 96906		EA	1	
93	8	XBFZZ	XB	XBGZZ	PAFZZ		5920-00-875-4100	FUSEHOLDER FHN26G2 81349		EA	1	
93	9	PAOZZ	PAOZZ	PAOZZ	PAOZZ		5920-00-474-6125	FUSE, GLASS FO2A250V2AS 81349		EA	1	
93	10	PAFZZ	PAOZZ	XBGZZ	PAFZZ		6210-00-686-4999	LIGHT ASSEMBLY MS25331-2 96906		EA	1	
93	11	PAOZZ	PAOZZ	PAOZZ	PAOZZ		6240-00-155-8714	LAMP, INCANDESCENT MS25231-313 96906		EA	2	
93	12	PAFZZ	PAOZZ	XBGZZ	PAFZZ		6210-00-688-5088	LIGHT, INDICATOR MS25331-4 96906		EA	1	
93	13	PAOZZ	PAOZZ	PAOZZ	PAOZZ		6240-00-155-8714	LAMP, INCANDESCENT MS25231-313 96906		EA	1	
93	14	PAFZZ	PAOZZ	PAGZZ	PAFZZ		6145-00-578-6605	WIRE, JUMPER M5068-2-16-9 81349		FT	V	
93	15	PAFZZ	PAOZZ	XBGZZ	PAFZZ		5310-00-934-9751	NUT, PLAIN, HEXAGON: RECTIFIER MTG MS35650-302 96906		EA	4	
93	16	PAFZZ	PAOZZ	XBGZZ	PAFZZ		5310-00-596-7691	WASHER, LOCK: RECTIFIER MTG MS35335-32 96906		EA	4	
93	17	PAFZZ	PAOZZ	XBGZZ	PAFZZ		5310-00-082-1404	WASHER, FLAT: RECTIFIER MTG MS27183-6 96906		EA	4	
93	18	PAFZZ	PAOZZ	PAGZZ	PAFZZ		5961-00-724-5970	RECTIFIER JAN1N1204A 81349		EA	2	
93	19	PAFZZ	PAOZZ	PAGZZ	PAFZZ		5961-00-998-9317	RECTIFIER JAN1N1204RA 81349		EA	2	
93	20	PAFZZ	PAOZZ	XBGZZ	PAFZZ		5310-00-063-7360	NUT, WASHER, HEAT SINK 69-561-2 30554 511-061800-00 78187		EA	4	

(1) ILLUSTRATION A	(2) SMR CODE A	B	C	D	(3) A	B	(4) NATIONAL STOCK NUMBER	(5) DESCRIPTION REF NUMBER & MFR CODE	(6) USABLE ON CODE U/M	(7) QTY INC IN UNITS	(8) USMC QTY PER EQUIP
93	21	PAFZZ	PAOZZ	XBGZZ	PAFZZ		5305-00-036-6968	SCREW, WASHER: HEAT SINK 69-662-18 30554 P15121-8 45722	EA	12	
93	22	PAFZZ	PAOZZ	PAGZZ	PAFZZ		5310-00-063-7360	NUT, WASHER: HEAT SINK MTG 69-561-2 30554 511-061800-00 78187	EA	2	
93	23	PAFZZ	PAOZZ	PAGZZ	PAFZZ		5310-00-082-1404	WASHER, FLAT: HEAT SINK MTG MS27183-6 96906	EA	2	
93	24	PAFZZ	PAOZZ	XBGZZ	PAFZZ		5310-00-883-9384	WASHER, FLAT: HEAT SINK MS1595-842 96906	EA	4	
93	25	PAFZZ	PAOZZ	PAGZZ	PAFZZ		5305-00-038-3122	SCREW, WASHER: HEAT SINK MTG 69-662-34 30554 P15121-34 45722	EA	4	
93	26	XBFZZ	XB	XBGZZ	XBFZZ			WASHER, SHOULDER: HEAT SINK 70-1050-1 30554 2642-24850N140 06540	EA	8	
93	27	XBFZZ	MFO	XBGZZ	XBFZ			HEAT SINK 70-1282 30554 30554-70-1282 36024	EA	1	
93	28	XBFZZ	MFO	XBGZZ	XBFZZ			HEAT SINK 70-1283 30554 30554-80-1283 36024	EA	1	
93	29	PAFZZ	PAOZZ	PAGZZ	PAFZZ		5325-00-185-0012	GROMMET, SPLIT MS35489-35 96906	EA	1	
93	30	PAFZZ	PAOZZ	PAGZZ	PAFZZ		5305-00-038-3122	SCREW, WASHER: CLAMP MTG 69-662-34 30554 P15121-34 45722	EA	1	
93	31	PAFZZ	PAOZZ	XBGZZ	PAFZZ		5340-00-843-7825	CLAMP, CUSHION MS21333-68 96906	EA	1	
93	32	PAFZZ	PAOZZ	PAGZZ	PAFZZ		5305-00-038-3089	SCREW, WASHER: HEAT SINK BRACKET MTG P15121-3 45722	EA	4	
93	33	XBFZZ	MFO	XBGZZ	XBFZZ			BRACKET, HEAT SINK 70-1284 30554 30554-70-1284 36024	EA	1	
93	34	PAFZZ	PAOZZ	PAGZZ	PAFZZ		5310-00-063-7360	NUT, WASHER: RELAY MTG 69-561-2 30554 511-061800-00 78189	EA	2	
93	35	PAFZZ	PAOZZ	XBGZZ	PAFZZ		5305-00-036-6972	SCREW, WASHER: RELAY MTG 69-662-20 30554 P15121-20 45722	EA	2	
93	36	PAFZZ	PAOZZ	XBGZZ	PAFZZ		5970-00-311-5943	WASHER, SHOULDER: RELAY MTG 70-1050-2 30554 2661-20385N152 06540	EA	2	
93	37	PAFZZ	PAOZZ	PAFZZ	PAFZZ		5999-00-332-0010	RELAY, POWER 70-1286 30554 X1516 14740	EA	1	
93	38	XBFZZ	MFO	XBGZZ	XBFZZ			INSULATOR, RELAY 70-1466 30554 30554-70-1466 36024	EA	1	

TM9-6115-465-24P
 TO35CZ-3-446-4
 NAVFACP-8-625-24P
 SL-4-06858B/06859D

(1) ILLUSTRATION		(2) SMR CODE				(3)		(4) NATIONAL STOCK NUMBER	(5) DESCRIPTION	(6) USABLE ON CODE	(7) QTY INC IN UNITS	(8) USMC QTY PER EQUIP
A FIG. NO.	B ITEM NO.	A ARMY	B AIR FORCE	C NAVY	D USMC	A SSI	B REPL FACTOR	REF NUMBER & MFR CODE	U/M			
93	39	PAFZZ	PAOZZ	XBGZZ	PAFZZ			5310-00-094-3421 NUT, WASHER: TRANSFORMER MTG 69-561-4 30554 511-101800-00 78189	EA	4		
93	40	PAFZZ	PAOZZ	XBGZZ	PAFZZ			5305-00-036-6979 SCREW, WASHER: TRANSFORMER MTG 69-662-49 30554 P15121-49 45722	EA	4		
93	41	PAFZZ	PAOZZ	XBGZZ	PAFZZ			5950-00-333-0759 TRANSFORMER: V 70-1285 30554 7002-0018 93742	EA	1		
93	42	PAFZZ	PAOZZ	XBGZZ	PAFZZ			5305-00-038-3122 SCREW, WASHER COVER MTG 69-662-34 30554 P15121-34 45722	EA	4		
93	43	XBFZZ	PAOZZ	XBGZZ	XBFZZ			COVER, CONTROL BOX 70-2342 30554 30554-70-1231 36024	EA	1		
93	44	XBFZZ	MOO	XAGZZ	XBFZZ			CHASSIS, CONTROL BOX 70-1230 30554 30554-70-1230 36024	EA	1		
93	45	PAFZZ	PAOZZ	PAGZZ	PAFZZ			5310-00-063-7360 NUT, WASHER: WIRING HARNESS MTG 69056102 30554 511-061800-00 78189	EA	4		
93	46	PAFZZ	PAOZZ	PAGZZ	PAFZZ			5305-00-036-6972 SCREW, WASHER: WIRING HARNESS MTG 69-662-20 30554 P15121-20 45722	EA	4		
93	47	PAFZZ	PAOZZ	XBFZZ	PAFZZ			5310-00-063-7415 NUT, WASHER: WIRING HARNESS MTG 69-561-1 30554 511-041800-00 78189	EA	4		
93	48	PAFZZ	PAOZZ	XBGZZ	PAFZZ			5305-00-038-3089 SCREW, WASHER: WIRING HARNESS 69-662-3 30554 P15121-3 45722	EA	4		
93	49	PAFZZ	MOO	AGGGG	AFFZZ			WIRING HARNESS: CONTROL BOX 70-1233 30554 30554-70-1233 36024	EA	1		

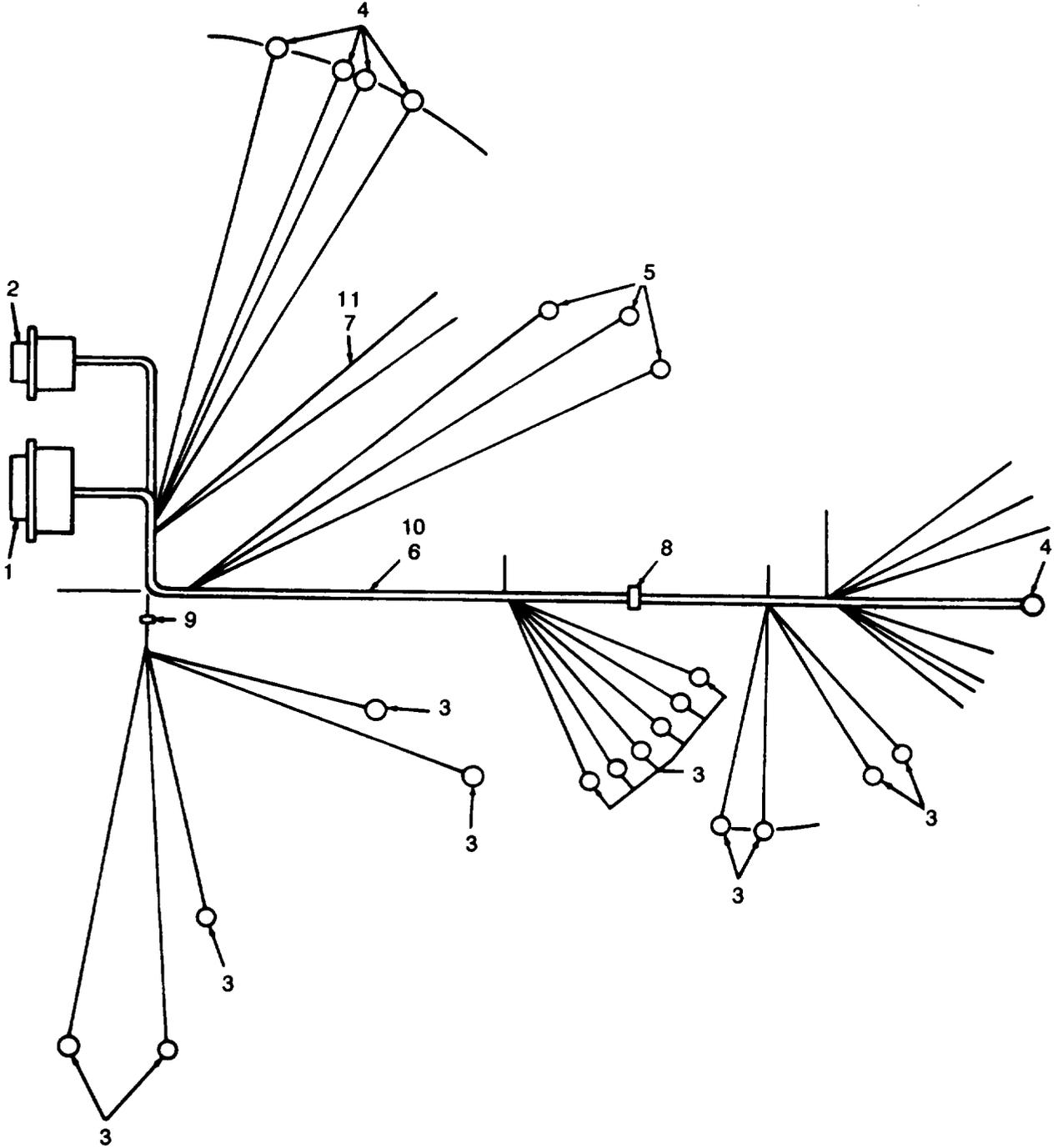

Figure 94. Electric heater control box wiring harness

TM9-6115-465-24P
 TO35CZ-3-446-4
 NAVFACP-8-625-24P
 SL-4-06858B/06859D

(1) ILLUSTRATION A	(2) SMR CODE A	B	C	D	(3) A	B	(4) NATIONAL STOCK NUMBER	(5) DESCRIPTION REF NUMBER & MFR CODE	(6) USABLE ON CODE	U/M	(7) QTY INC IN UNITS	(8) USMC QTY PER EQUIP
94	1	PAOZZ	PAOZZ	PAGZZ	PAFZZ		5935-00-755-2892	CONNECTOR, RECEPTACLE MS3102R28-9S 96906 70-1615-7 30554	EA		1	
94	2	PAOZZ	PAOZZ	PAGZZ	PAFZZ		5935-00-806-4588	CONNECTOR, RECEPTACLE MS3102R16-20P 96906 70-1615-3 30554	EA		1	
94	3	PAOZZ	PAOZZ	PAGZZ	PAFZZ		5940-00-283-5280	TERMINAL, LUG MS25036-106 96906	EA		18	
94	4	PAOZZ	PAOZZ	PAGZZ	PAFZZ		5940-00-143-4774	TERMINAL, LUG MS25036-153 96906	EA		6	
94	5	PAOZZ	PAOZZ	PAGZZ	PAFZZ		5940-00-143-4775	TERMINAL, LUG MS25036-156 96906	EA		1	
94	6	PAOZZ	PAOZZ	PAGZZ	PAFZZ		6145-00-578-6605	WIRE, ELECTRICAL M5086-2-16-9 81349	FT		V	
94	7	PAOZZ	PAOZZ	PAGZZ	PAFZZ		6145-00-578-7514	WIRE, ELECTRICAL M5086-2-12-9 81349	FT		V	
94	8	PAOZZ	PAOZZ	XBGZZ	PAFZZ		5975-00-074-2072	STRAP, CABLE MS3367-1-9 96906	FT		V	
94	9	PAOZZ	PAOZZ	XBGZZ	PAFZZ		5975-00-727-5153	STRAP, CABLE MS3367-4-9 96906	FT		V	
94	10	PAOZZ	PAOZZ	XBGZZ	PAFZZ		5970-00-914-3117	INSULATION SLEEVING M23053/5-109-2 81349	FT		V	
94	11	PAOZZ	PAOZZ	XBGZZ	PAFZZ		5970-00-914-3118	INSULATION SLEEVING M23053/5-190-0 81349	FT		V	

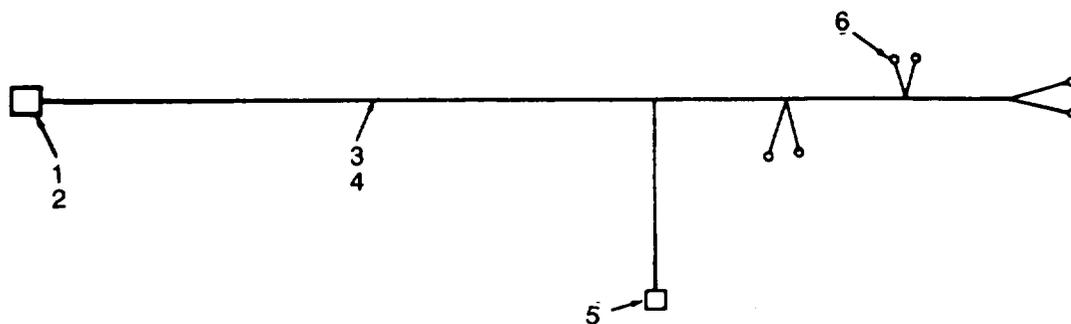

Figure 95. Electric winterization kit wiring harness.

TM9-6115-465-24P
 TO35CZ-3-446-4
 NAVFACP-8-625-24P
 SL-4-06858B/06859D

(1) ILLUSTRATION		(2) SMR CODE				(3)		(4) NATIONAL STOCK NUMBER	(5) DESCRIPTION	(6) USABLE ON CODE	(7) QTY INC IN UNITS	(8) USMC QTY PER EQUIP
A FIG. NO.	B ITEM NO.	A ARMY	B AIR FORCE	C NAVY	D USMC	A SSI	B REPL FACTOR	REF NUMBER & MFR CODE	U/M			
95		MOOZ	AFO	AGGGG	AFFZZ			WIRING HARNESS 72-2855 30554 30554-72-2855 36024	EA	1		
95	1	PAOZZ	PAOZZ	PAGZZ	PAFZZ			5935-00-879-0235 CONNECTOR, RECEPTACLE MS3106R28-9P 96906	EA	1		
95	2	PAOZZ	PAOZZ	XBGZZ	PAFZZ			5935-00-565-9503 PLUG, END SEAL MS25251-12 96906	EA	4		
95	3	PAOZZ	PAOZZ	PAGZZ	PAFZZ			6145-00-578-6605 WIRE, ELECTRICAL M5086-2-16-9 81349	FT	V		
95	4	PAOZZ	PAOZZ	XBGZZ	PAFZZ			5975-00-727-5153 STRAP, CABLE MS3367-4-9 96906	EA			
95	5	PAOZZ	PAOZZ	PAGZZ	PAFZ			5935-00-089-4487 CONNECTOR, ELECTRICAL MS3106R10SL4SC 96906	EA	1		
95	6	PAOZZ	PAOZZ	PAGZZ	PAFZZ			5940-00-143-4774 TERMINAL, LUG MS25036-153 96906	EA	6		

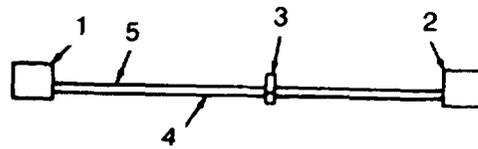

Figure 96. Control box to special relay box wiring harness.

TM9-6115-465-24P
 TO35CZ-3-446-4
 NAVFACP-8-625-24P
 SL-4-06858B/06859D

(1) ILLUSTRATION		(2) SMR CODE				(3)		(4) NATIONAL STOCK NUMBER	(5) DESCRIPTION	(6) USABLE ON CODE	(7) QTY INC IN UNITS	(8) USMC QTY PER EQUIP
A FIG. NO.	B ITEM NO.	A ARMY	B AIR FORCE	C NAVY	D USMC	A SSI	B REPL FACTOR	REF NUMBER & MFR CODE		U/M		
96		MOZZ	AFO	AGGZZ	AFFZZ			WIRING HARNESS 72-2875 30554 30554-72-2875 36024 MANUFACTURE FROM:		EA	1	
96	1	PAOZZ	PAOZZ	PAGZZ	PAFZZ			5935-00-879-3265 CONNECTOR MS3106R18-11P 96906		EA	1	
96	2	PAOZZ	PAOZZ	PAGZZ	PAFZZ			5935-00-725-4153 CONNECTOR MS3106R18-11S 96906		EA	1	
96	3	PAOZZ	POAZZ	XBGZZ	PAFZZ			5975-00-727-5153 STRAP, CABLE MS3367-4-9 96906		EA	V	
96	4	PAOZZ	PAOZZ	PAGZZ	PAFZZ			6145-00-578-6605 WIRE, ELECTRICAL M5086-2-16-9 81349		FT	V	
96	5	PAOZZ	PAOZZ	PAGZZ	PAFZZ			6145-00-578-7514 WIRE, ELECTRICAL M5086-2-12-9 81349		FT	V	

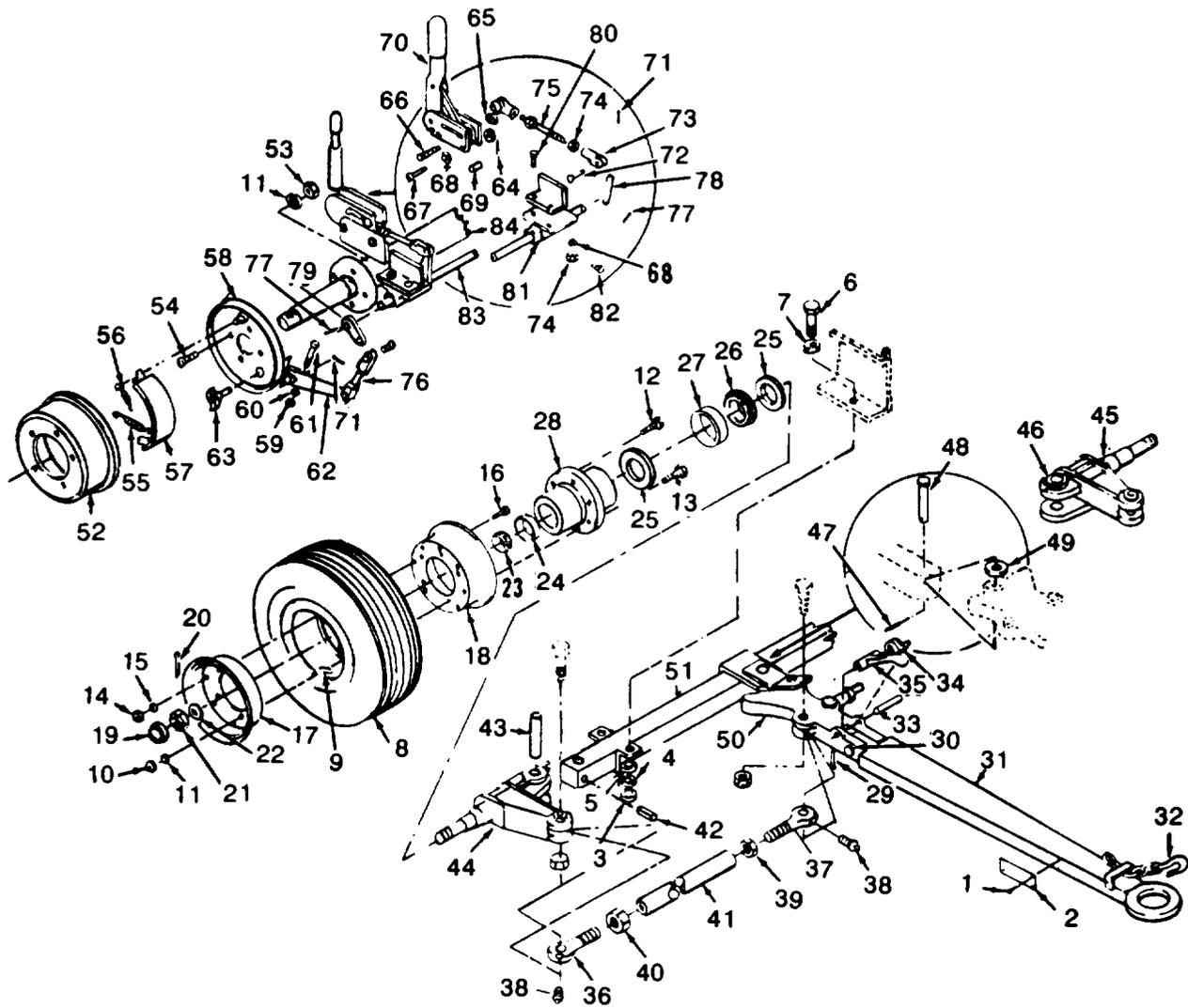

Figure 97. Wheel mounting kit.

(1) ILLUSTRATION A FIG. NO.	(2) SMR CODE B ITEM NO.	A	B AIR FORCE	C	D	(3)		B REPL FACTOR	(4) NATIONAL STOCK NUMBER	(5) DESCRIPTION REF NUMBER & MFR CODE	USABLE ON CODE	(6) U/M	(7) QTY INC IN UNITS	(8) USMC QTY PER EQUIP
						A	SSI							
										GROUP 27 - KIT - WHEEL MOUNTING				
97		PAOOO	PAOFF	XBHHH	PAOFF				6115-00-463-9094	KIT, WHEEL MTG 72-2833 30554 MEF005AWM 30554	EA		1	
97	1	XBOZZ	XB	XBGZZ	XBOZZ					RIVET, BLIND: IDENTIFICATION PLATE MTG MS24243-1D404 96906	EA		4	
97	2	XBOZZ	XB	XBHZZ	MDOZZ					PLATE, IDENTIFICATION 72-2839 30554 30554-72-2839 36024	EA		1	
97	3	PAOZZ	PAOZZ	PAGZZ	PAOZZ				5310-00-768-0318	NUT, PLAIN, HEXAGON: GENERATOR MTG MS51967-14 96906	EA		8	
97	4	PAOZZ	PAOZZ	PAGZZ	PAOZZ				5310-00-584-5272	WASHER, LOCK: GENERATOR MTG MS35338-48 96906	EA		8	
97	5	PAOZZ	PAOZZ	PAGZZ	PAOZZ				5310-00-809-5997	WASHER, FLAT: GENERATOR MTG MS27183-17 96906	EA		8	
97	6	PAOZZ	PAOZZ	PAGZZ	PAOZZ				5035-00-782-9495	SCREW, CAP, HEXAGON HEAD: GENERATOR MTG MS90725-111 96906	EA		8	
97	7	XBOZZ	XB	XBGZZ	XBOZZ					WASHER, BEVELED: GENERATOR MTG 70-1531-2 30554 30554-70-1531-2 36024	EA		8	
97		XBOZZ	XA	XBHHA	PAOZZ				6115-00-480-9472	RUNNING, GEAR 72-2834 30554	EA		1	
97	8	PAOZZ	PAOZZ	PAOZZ	PAOZZ				2610-00-414-6458	TIRE ZZT410A 81348	EA		4	
97	9	PAOZZ	PAOZZ	PAOOO	PAOZZ				2610-00-444-7575	TUBE, TIRE ZZ100550 81348	EA		4	
97	10	PAOZZ	PAOZZ	PAGZZ	PAOZZ				5310-00-732-0560	NUT, PLAIN, HEXAGON: WHEEL STUD MS51968-14 96906	EA		20	
97	11	PAOZZ	PAOZZ	PAGZZ	PAOZZ				5310-00-584-5272	WASHER, LOCK: WHEEL STUD MS35338-48 96906	EA		20	
97	12	PAOZZ	PAOZZ	PAGZZ	PAFZZ				5306-00-882-7811	STUD, WHEEL 16-806 95026	EA		10	
97	13	PAOZZ	PAOZZ	PAGZZ	PAFZZ				5307-00-839-1373	STUD, WHEEL 15-806 95026	EA		10	
97	14	PAOZZ	PAOZZ	PAGZZ	PAOZZ				5310-00-853-9336	NUT, PLAIN, HEXAGON: WHEEL DISK MS35691-24 96906	EA		32	
97	15	PAOZZ	PAOZZ	PAGZZ	PAOZZ				5310-00-637-9541	WASHER, LOCK: WHEEL DISC MTG MS35338-46 96906	EA		40	
97	16	PAOZZ	PAOZZ	PAGZZ	PAOZZ				5305-00-269-2801	SCREW, CAP, HEXAGON HEAD: WHEEL DISC MTG MS90726-58 96906	EA		32	
97	17	XBOZZ	XB	PAOZZ	PAOZZ				2530-01-024-8328	DISC, WHEEL 15-901-2 95026	EA		4	
97	18	XBOZZ	XB	PAOZZ	XBOZZ					DISC, WHEEL 15-901-1 95026	EA		4	

(1) ILLUSTRATION A	(2) SMR CODE A	(2) SMR CODE B	(2) SMR CODE C	(2) SMR CODE D	(3) A	(3) B	(4) NATIONAL STOCK NUMBER	(5) DESCRIPTION REF NUMBER & MFR CODE	(6) USABLE ON CODE	(6) U/M	(7) QTY INC IN UNITS	(8) USMC QTY PER EQUIP
97	19	XBOZZ	XB	XBGZZ	PAOZZ		2530-00-589-8537	CAP, BEARING 15-1001 95026		EA	4	
97	20	XBOZZ	XB	XBZZ	XBOZZ			PIN, COTTER: AXLE NUT 9-148 95026		EA	4	
97	21	PAOZZ	PAOZZ	PAHZZ	PAOZZ		5310-00-911-5467	NUT, PLAIN, HEXAGON: AXLE NUT 2-906 95026		EA	4	
97	22	PAOZZ	PAOZZ	PAGZZ	PAOZZ		5310-00-911-5468	WASHER, FLAT: AXLE NUT 17-914 95026		EA	4	
97	23	PAOZZ	PAOZZ	PAGZZ	PAOZZ		3110-00-198-2169	CONE, BEARING: WHEEL, OUTER 17-136 95026		EA	4	
97	24	PAOZZ	PAOZZ	PAOZZ	PAOZZ		3110-00-198-2170	CUP, BEARING: AXLE, OUTER 17-135 95026		EA	4	
97	25	PAOZZ	PAOZZ	PAGZZ	PAOZZ		5330-00-631-6649	SEAL, GREASE: WHEEL 14-1000 95026		EA	4	
97	26	PAOZZ	PAOZZ	PAGZZ	PAOZZ		3110-00-100-3537	CONE, BEARING: WHEEL, INNER 17-138 95026		EA	4	
97	27	PAOZZ	PAOZZ	PAGZZ	PAOZZ		3110-00-100-0542	CUP, BEARING: WHEEL, INNER 17-137 95026		EA	4	
97	28	XBOZZ	XB	XBZZ	XBZZ			HUB, AXLE 606 95026		EA	4	
97	29	XBOZZ	PAOZZ	XBGZZ	XBOZZ			PIN, COTTER: HINGE PIN 9-207 95026		EA	1	
97	30	PAOZZ	PAOZZ	PAOZZ	PAOZZ		5315-00-806-9711	PIN, HINGE: DRAWBAR 14-801 95026		EA	1	
97	31	XBOZZ	XB	XBZZ	XBOZZ			DRAWBAR 74-7016 95026		EA	1	
97	32	XBOZZ	XB	XBZZ	XBOZZ			CHAIN, SAFETY 22-407 95026		EA	2	
97	33	PAOZZ	PAOZZ	XBGZZ	PAOZZ		5315-01-025-4754	PIN, ROLL: LATCH 11-400 95026		EA	1	
97	34	PAOZZ	PAOZZ	PAGZZ	PAOZZ		2530-00-947-3935	SPRING, LATCH 1-1983 95026		EA	1	
97	35	PAOZZ	PAOZZ	PAHZZ	PAOZZ		2530-00-759-1967	LATCH, DRAWBAR 9200 95026		EA	1	
97	36	PAOZZ	PAOZZ	PAHZZ	PAFZZ		2530-00-883-1099	ROD END, TIE 403-11 95026		EA	2	
97	37	PAOZZ	PAOZZ	PAHZZ	PAFZZ		2530-00-883-1098	ROD END, TIE 403-10 95026		EA	2	
97	38	PAOZZ	PAOZZ	XBGZZ	PAOZZ		4730-00-911-5481	FITTING, LUBE 4-410 95026		EA	5	
97	39	XBOZZ	XB	PAGZZ	XBZZ			NUT, PLAIN, HEXAGON: TIE ROD END 3-907 95026		EA	2	
97	40	PAOZZ	PAOZZ	PAGZZ	PAFZZ		5310-00-881-1768	NUT, PLAIN, HEXAGON: TIE-DOWN END 4-907 95026		EA	2	
97	41	XBOZZ	XB	XBZZ	XBZZ			TUBE, TIE ROD 16TU1710 95026		EA	2	

(1) ILLUSTRATION A	(2) SMR CODE A	(3) A	(4) NATIONAL STOCK NUMBER	(5) DESCRIPTION	(6) USABLE ON CODE	(7) QTY INC IN UNITS	(8) USMC QTY PER EQUIP					
								B	C	D	B	U/M
FIG. NO.	ITEM NO.	ARMY	AIR FORCE	NAVY	USMC	SSI	REPL FACTOR	REF NUMBER & MFR CODE				
97	42	PAOZZ	PAOZZ	XBGZZ	PAFZZ			5315-01-025-4737	PIN, ROLL: KING PIN 18-400 95026	EA	2	
97	43	PAOZZ	PAOZZ	XBHZZ	PAFZZ			2530-00-613-6061	KING PIN: SPINDLE 7-809 95026	EA	2	
97	44	PAOZZ	PAOZZ	PAHZZ	PAFZZ			2530-00-873-4384	SPINDLE, KNUCKLE 3-1205 95026	EA	1	
97	45	PAOZZ	PAOZZ	PAHZZ	PAFZZ			2530-00-873-4385	SPINDLE, KNUCKLE 4-1205 95026	EA	1	
97	46	PAOZZ	PAOZZ	XBGZZ	PAOZZ			4730-00-808-3833	FITTING, LUBE 3-410 95026	EA	4	
97	47	PAOZZ	PAOZZ	XBGZZ	PAOZZ			5315-00-297-2444	PIN, COTTER: CENTER ARM PIN MS24665-623 96906	EA	1	
97	48	PAOZZ	PAOZZ	XBGZZ	PAOZZ			5315-00-373-0030	PIN, STRAIGHT, HEADED: CENTER ARM 19-800 95026	EA	1	
97	49	PAOZZ	PAOZZ	XBGZZ	PAOZZ			5310-00-288-2674	WASHER, SPACER: CENTER ARM 11X147 95026	EA	1	
97	50	XBOZZ	XB	XBHZZ	PAOZZ			2530-00-759-1968	ARM, CENTER 2-522 95026	EA	1	
97	51	XBOZZ	XB	XBHZZ	XBFBZZ				AXLE, FRONT 4020-6 95026	EA	1	
97	52	XBOZZ	XB	XBGZZ	PAFZZ			2530-00-425-8300	SHIELD: DUST: BRAKE 8142-1 95026	EA	2	
97	53	PAOZZ	PAOZZ	PAGZZ	PAFZZ			5310-00-732-0559	NUT, PLAIN, HEXAGON: BACKING PLATE MS51968-8 96906	EA	8	
97	54	PAOZZ	PAOZZ	PAGZZ	PAFZZ			5305-00-269-2805	SCREW, CAP, HEXAGON HEAD: BACKING PLATE MS90726-62 96906	EA	8	
97	55	PAOZZ	PAOZZ	PAHZZ	PAFZZ			4520-00-625-2977	SPRING, RETURN 8142-6 95026	EA	2	
97	56	PAOZZ	PAOZZ	XBHZZ	PAHZZ			2530-00-602-2544	SPRING, HOLD-DOWN 8142-5 95026	EA	4	
97	57	PAOZZ	PAOZZ	PAHZZ	PAFZZ			2530-00-175-9637	BRAKE SHOE 8142-4 95026	EA	4	
97	58	XBOZZ	XB	XBHZZ	XBFBZZ				PLATE, BACKING 8142-3 95026	EA	2	
97	59	PAOZZ	PAOZZ	XBGZZ	PAFZZ			5310-01-007-8524	NUT, PLAIN, HEXAGON: CAM LEVER 5X101 95026	EA	2	
97	60	PAOZZ	PAOZZ	XBGZZ	PAFZZ			5310-01-007-8642	WASHER, LOCK: CAM LEVER 12X168 95026	EA	2	
97	61	PAOZZ	PAOZZ	XBOZZ	PAFZZ			5306-01-008-6495	BOLT, HEXAGON: CAM LEVER 1X167 95026	EA	2	
97	62	XBOZZ	XB	XBHZZ	XBFBZZ				LEVER, CAMSHAFT 8142-8 95026	EA	2	
97	63	XBOZZ	XB	XBHZZ	XBFBZZ				CAMSHAFT, BRAKE 8142-7 95026	EA	2	
97	64	PAOZZ	PAOZZ	PAGZZ	PAFZZ			5315-00-218-6316	PIN, COTTER: CAM LEVER PIN 7064-5 95026	EA	1	

(1) ILLUSTRATION		(2) SMR CODE				(3)		(4)	(5)	(6)	(7)	(8)
A	B	A	B	C	D	A	B	NATIONAL STOCK NUMBER	DESCRIPTION	USABLE ON CODE	QTY INC IN UNITS	USMC QTY PER EQUIP
FIG. NO.	ITEM NO.	ARMY	AIR FORCE	NAVY	USMC	SSI	REPL FACTOR		REF NUMBER & MFR CODE	U/M		
97	65	PAOZZ	PAOZZ	PAGZZ	PAFZZ			5310-00-218-4219	WASHER, FLAT: LEVER 7064-4 95026	EA	1	
97	66	PAOZZ	POAZZ	XBGZZ	PAFZZ			5310-00-359-0752	PIN, LEVER 7064-3 95026	EA	1	
97	67	XBOZZ	XB	XBGZZ	XBFZZ				SCREW 1X169 95026	EA	2	
97	68	PAOZZ	PAOZZ	PAGZZ	PAFZZ			5310-00-637-9541	WASHER, LOCK MS35338-46 96906	EA	7	
97	69	XBOZZ	XB	XBGZZ	PAFZZ			5365-00-408-6019	SPACER, LEVER 7064-2 95026	EA	2	
97	70	PAOZZ	PAOZZ	XBHZZ	PAFZZ			2530-00-408-9176	LEVER ASSEMBLY, HEAD 7064-1 95026	EA	1	
97	71	PAOZZ	PAOZZ	XBGZZ	PAFZZ			5315-00-842-3044	PIN, COTTER: YOKE PIN MS24665-283 96906	EA	5	
97	72	PAOZZ	PAOZZ	PAGZZ	PAFZZ			5315-00-193-4113	PIN, YOKE 33X203 95026	EA	5	
97	73	PAOZZ	XB	XBHZZ	PAFZZ			4030-00-410-0561	YOKE 25-7046 95026	EA	6	
97	74	PAOZZ	PAOZZ	PAGZZ	PAFZZ			5310-00-269-6302	NUT, PLAIN, HEXAGON NT1138 01843	EA	12	
97	75	XBOZZ	XB	XBGZZ	XBFZZ				ROD 7046-040 95026	EA	1	
97	76	XBOZZ	XB	XBGZZ	XBFZZ				ROD 7046-025 95026	EA	1	
97	77	PAOZZ	PAOZZ	PAGZZ	PAFZZ			5315-00-543-3714	PIN 27X465C 95026	EA	3	
97	78	XBOZZ	XB	XBHZZ	PAFZZ			2530-00-873-5318	LEVER 7047-6 95026	EA	1	
97	79	XBOZZ	XB	XBGZZ	PAFZZ			2530-00-871-6901	LEVER 7047-3 95026	EA	2	
97	80	XBOZZ	XB	XBGZZ	XBFZZ				BOLT 1X165 95026	EA	4	
97	81	XBOZZ	XB	XBHZZ	XBFZZ				BEARING, BLOCK 7047-5 95026	EA	2	
97	82	XBOZZ	XB	XBGZZ	XBOZZ				FITTING, LUBE 8-410 95026	EA	2	
97	83	XBOZZ	XB	XBHZZ	XBFZZ				SHAFT, CROSS 125-7047 95026	EA	1	
97	84	XBOZZ	XB	XBHZZ	XBFZZ				AXLE, REAR 40-4508 95026	EA	1	

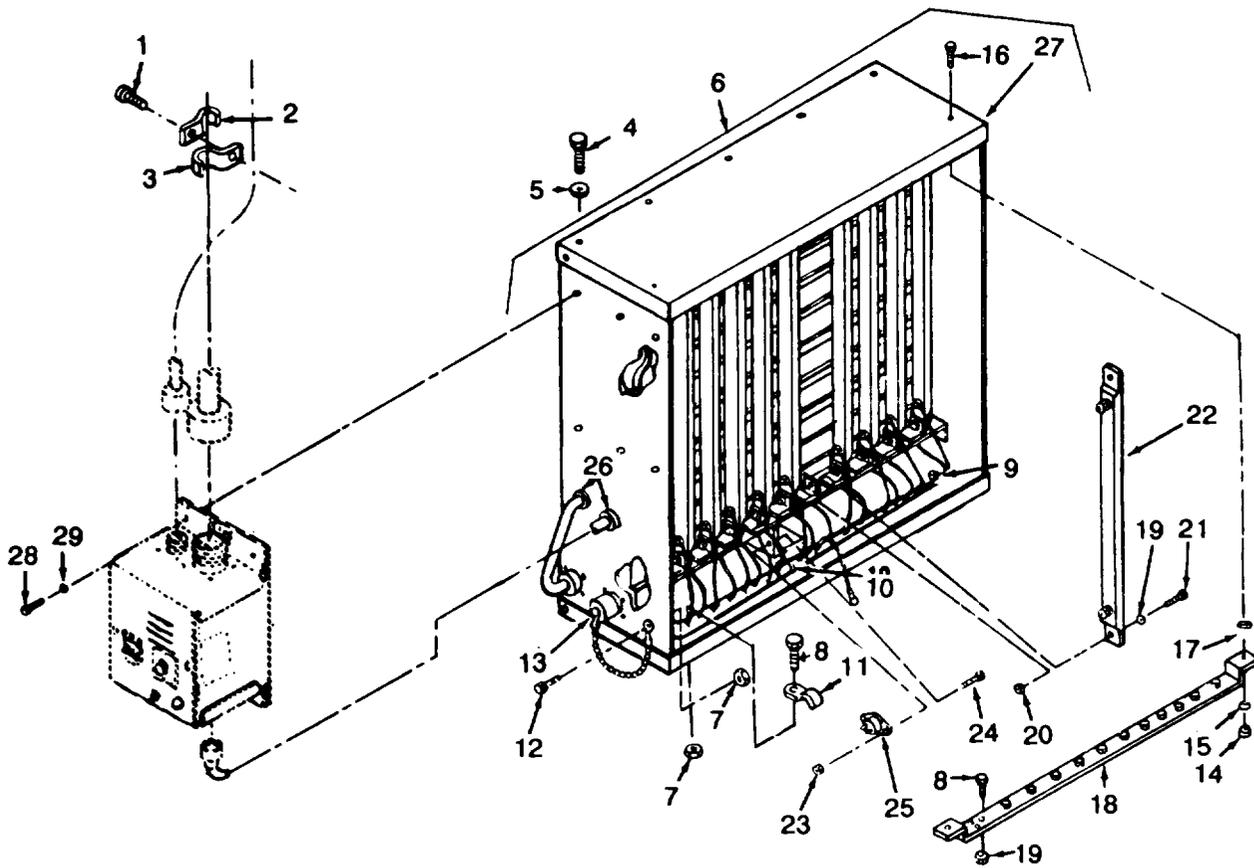

Figure 98. Load bank kit

(1) ILLUSTRATION A FIG. NO.	(2) SMR CODE B ITEM NO.	A	B AIR FORCE	C	D	(3)		(4) NATIONAL STOCK NUMBER	(5) DESCRIPTION REF NUMBER & MFR CODE	(6) USABLE ON CODE U/M	(7) QTY INC IN UNITS	(8) USMC QTY PER EQUIP
						A	B REPL FACTOR					
									GROUP 28 - LOAD BANK			
98		PAOFH	PAOFF	PBHHH	PAFFF			6115-00-463-9088	KIT, LOAD BANK 72-2874 30554 30554-72-2874 36024	EA	1	
98	1	PAOZZ	PAOZZ	PAGZZ	PAFZZ			5305-00-068-0502	SCREW, CAP, HEXAGON HEAD: CLAMP MTG MS90725-6 96906	EA	3	
98	2	PAOZZ	PAOZZ	PAGZZ	PAFZZ			5340-00-984-8540	CLAMP, LOOP: WIRING HARNESS MS21333-102 96906	EA	4	
98	3	PAOZZ	PAOZZ	PAGZZ	PAFZZ			5340-00-809-1494	CLAMP, LOOP: WIRING HARNESS 70-1529-26 30554	EA	4	
98	4	PAOZZ	PAOZZ	PAGZZ	PAFZZ			5305-00-068-0502	SCREW, CAP, HEXAGON HEAD: LOAD BANK MTG MS90725-6 96906	EA	20	
98	5	PAOZZ	PAOZZ	PAGZZ	PAFZZ			5310-00-584-5272	WASHER, LOCK: LOAD BANK MTG MS35338-44 96906	EA	20	
98	6	XBOFH	XA	XAHHH	XAPFF				LOAD BANK ASSEMBLY 72-2866 30554 30554-72-2866 36024	EA	1	
98	7	PAFZZ	PAOZZ	PAGZZ	PAFZZ			5310-00-934-9757	NUT, PLAIN, HEXAGON: CAP MTG MS35649-282 96906	EA	24	
98	8	PAFZZ	PAOZZ	XBGZZ	PAFZZ			5305-00-984-6211	SCREW, MACHINE: BUS BAR MS35206-263 96906	EA	24	
98	9	PAFZZ	PAOZZ	PAGZZ	PAFZZ			5340-00-057-2904	CLAMP, LOOP MS21333-71 96906	EA	3	
98	10	PAFZZ	PAOZZ	PAGZZ	PAFZZ			5340-00-079-7873	CLAMP, LOOP MS21333-67 96906	EA	3	
98	11	PAFZZ	PAOZZ	PAGZZ	PAFZZ			5340-00-050-2740	CLAMP, LOOP MS21333-75 96906	EA	8	
98	12	PAFZZ	PAOZZ	PAGZZ	PAFZZ			5305-00-038-3103	SCREW, WASHER: CAP MTG 69-662-35 30554 P15121-35 45722	EA	1	
98	13	PAFZZ	PAOZZ	XBGZZ	PAFZZ			5935-00-137-4879	CAP, PROTECTIVE MS25043-28D 96906	EA	1	
98	14	PAFZZ	PAOZZ	PAGZZ	PAFZZ			5310-00-934-9747	NUT, PLAIN, HEXAGON: BUS BAR MS35649-202 96906	EA	21	
98	15	PAFZZ	PAOZZ	PAGZZ	PAFZZ			5310-00-809-4058	WASHER, FLAT: HEATER STRIP MTG MS27183-10 96906	EA	48	
98	16	PAFZZ	PAOZZ	PAGZZ	PAFZZ			5305-00-036-6968	SCREW, WASHER: BUS BAR 69-662-50 30554 P15121-50 45722	EA	19	
98	17	XBFZZ	XB	XBGZZ	XBFZZ				WASHER, PLASTIC: BUS BAR 72-2818 30554 21B1003-2 81073	EA	4	
98	18	XBFZZ	MFO	XBGZZ	XBFZZ				BUS BAR 72-2812 30554 30554-72-2812 36024	EA	1	

TM9-6115-465-24P
 TO35CZ-3-446-4
 NAVFACP-8-625-24P
 SL-4-06858B/06859D

(1) ILLUSTRATION		(2) SMR CODE				(3)		(4) NATIONAL STOCK NUMBER	(5) DESCRIPTION	(6) USABLE ON CODE	(7) QTY INC IN UNITS	(8) USMC QTY PER EQUIP
A FIG. NO.	B ITEM NO.	A ARMY	B AIR FORCE	C NAVY	D USMC	A SSI	B REPL FACTOR	REF NUMBER & MFR CODE	U/M			
98	19	PAFZZ	PAOZZ	PAGZZ	PAFZZ			5310-00-094-3421 NUT, WASHER: BUS BAR 69-561-4 30554 511-101800-00 78189	EA	14		
98	20	PAFZZ	PAOZZ	PAGZZ	PAFZZ			5310-00-696-5173 NUT, WASHER: HEATER STRIP MTG 69-561-5 30554 511-251800-00 78189	EA	48		
98	21	PAFZZ	PAOZZ	PAGZZ	PAFZZ			5305-00-068-0502 SCREW, CAP, HEXAGON HEAD: HEATER STRIP MTG MS90725-6 96906	EA	48		
98	22	XBFZZ	XB	PAGZZ	XBFZZ			HEATER STRIP 72-2810-2 30554 2A917B102 04178	EA	24		
98	23	PAFZZ	PAOZZ	PAGZZ	PAFZZ			5310-00-934-9739 NUT, PLAIN, HEXAGON: SWITCH MTG MS35649-242 96906	EA	2		
98	24	PAFZZ	PAOZZ	PAGZZ	PAFZZ			5305-00-038-3089 SCREW, WASHER: SWITCH MTG 69-662-3 30554 P15121-3 45722	EA	2		
98	25	PAFZZ	PAOZZ	PAGZZ	PAFZZ			SWITCH, THERMOSTAT 70-1417 30554 MI450351-282 01295	EA	1		
98	26	PAFZZ	PAOZZ	PAGZZ	PAFZZ			5325-00-174-9038 GROMMET, SPLIT MS35489-20 96906	EA	2		
98	27	XBFZZ	XB	XBHZZ	XBFZZ			HOUSING 72-2801 30554	EA	1		
98	28	PAFZZ	PAOZZ	PAGZZ	PAFZZ			5305-00-068-0500 SCREW, CAP, HEXAGON HEAD: CONTROL BOX MTG MS90725-3 96906	EA	6		
98	29	PAFZZ	PAOZZ	PAGZZ	PAFZZ			5310-00-584-5272 WASHER, LOCK: CONTROL BOX MTG MS35338-44 96906	EA	6		

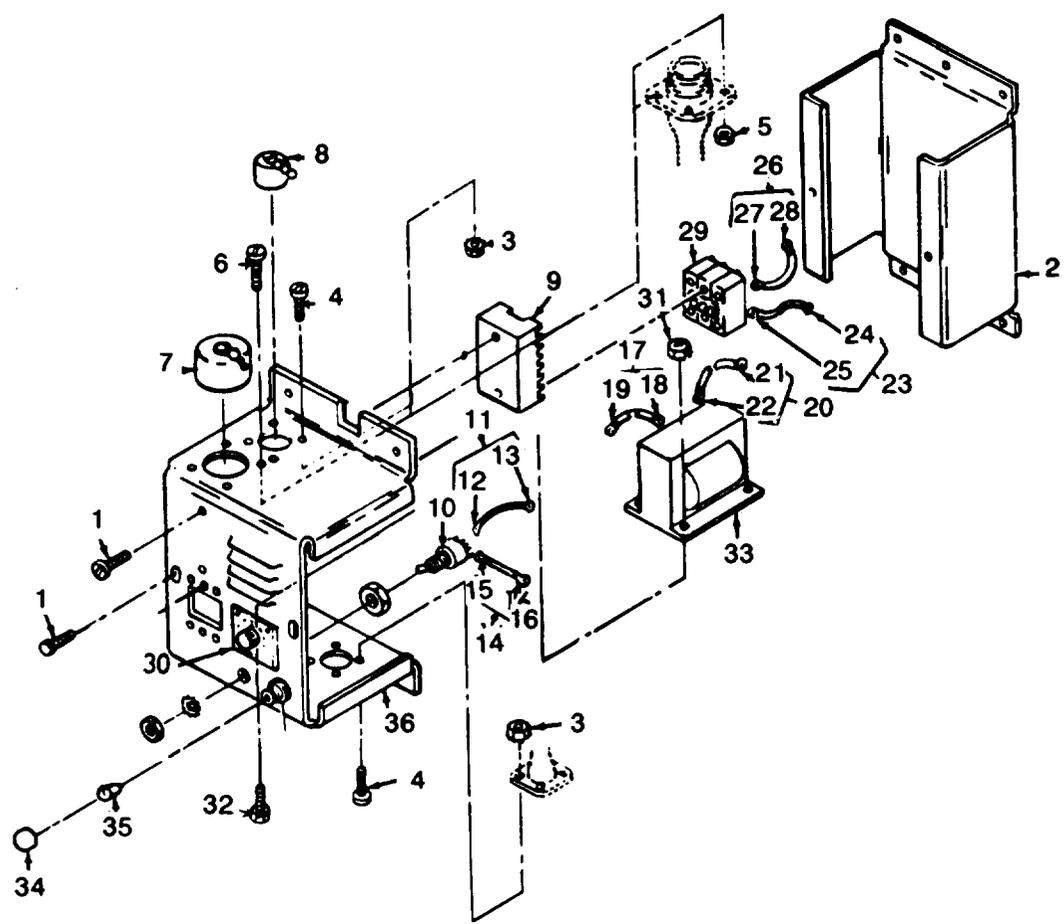

Figure 99. Load bank control box

(1) ILLUSTRATION A	(2) SMR CODE A	B	C	D	(3) A	B	(4) NATIONAL STOCK NUMBER	(5) DESCRIPTION REF NUMBER & MFR CODE	(6) USABLE ON CODE U/M	(7) QTY INC IN UNITS	(8) USMC QTY PER EQUIP
99		MFFZZ	AFO	AHHHH	AFFZZ			CONTROL BOX. LOAD BANK 72-2808 30554 30554-72-2808 36024	EA	1	
99	1	PAFZZ	PAOZZ	PAGZZ	PAFZZ		5305-00-191-6226	SCREW, WASHER: COVER MTG 69-662-64 30554 P15121-64 45722	EA	4	
99	2	XBFZZ	XB	XAGZZ	XBFZZ			BASE, CONTROL BOX 72-2803 30554 30554-72-2803 36024	EA	1	
99	3	PAFZZ	PAOZZ	PAGZZ	PAFZZ		5310-00-934-9747	NUT, PLAIN, HEXAGON: WIRING HARNES MTG MS35649-262 96906	EA	8	
99	4	PAFZZ	PAOZZ	PAGZZ	PAFZZ		5305-00-036-6972	SCREW, WASHER: WIRING HARNESS MTG 69-662-20 30554 P15121-20 45722	EA	8	
99	5	PAFZZ	PAOZZ	PAGZZ	PAFZZ		5310-00-934-9735	NUT, PLAIN, HEXAGON: WIRING HARNES MTG 69-5614 30554 511-041800-00 78189	EA	4	
99	6	PAFZZ	PAOZZ	PAGZZ	PAFZZ		5305-00-038-3089	SCREW WASHER: WIRING HARNESS MTG MS35206-215 96906	EA	4	
99	7	PAOZZ	PAOZZ	XBGZZ	PAOZZ		5935-00-232-7208	CAP, DUST MS25043-32D 96906	EA	1	
99	8	PAOZZ	PAOZZ	XBGZZ	PAOZZ		5935-00-500-5008	CAP, DUST MS25043-18D 96906	EA	1	
99	9	PAFZZ	PAOZZ	PAGZZ	PAFZZ		6115-00-610-2119	MODULE, SENSING 30554-72-2832 36024 72-2832 30554	EA	1	
99	10	PAFZZ	PAOZZ	PAGZZ	PAFZZ		5935-00-655-1514	SWITCH, TOGGLE MS35058-22 96906	EA	1	
99	11	MFFZZ	MFO	MGGZZ	MFFZZ			LEAD, ELECTRICAL 72-1868-3 30554 30554-72-1868-3 36024 MANUFACTURE FROM:	EA	1	
99	12	PAFZZ	PAOZZ	PAGZZ	PAFZZ		5940-00-283-5280	TERMINAL, LUG MS25036-106 96906	EA	1	
99	13	PAFZZ	PAOZZ	PAGZZ	PAFZZ		6145-00-578-6605	WIRE, ELECTRICAL M5086-2-16-9 81349	FT	V	
99	14	MFFZZ	MFO	MGGZZ	MFFZZ			LEAD, ELECTRICAL 72-2868-4 30554 30554-72-2868-4 36024 MANUFACTURE FROM:	EA	1	
99	15	PAFZZ	PAOZZ	PAGZZ	PAFZZ		5940-00-283-5280	TERMINAL LUG MS25036-106 96906	EA	1	
99	16	PAFZZ	PAOZZ	PAGZZ	PAFZZ		6145-00-578-6605	WIRE, ELECTRICAL M5086-2-16-9 96906	FT	V	
99	17	MFFZZ	MFO	MGGZZ	MFFZZ			LEAD, ELECTRICAL 72-2868-1 30554 30554-72-2868-1 3602 MANUFACTURE FROM:	EA	1	

(1) ILLUSTRATION		(2) SMR CODE				(3)		(4)	(5)	(6)	(7)	(8)
A	B	A	B	C	D	A	B	NATIONAL STOCK NUMBER	DESCRIPTION	USABLE ON CODE	QTY INC IN UNITS	USMC QTY PER EQUIP
FIG. NO.	ITEM NO.	ARMY	AIR FORCE	NAVY	USMC	SSI	REPL FACTOR		REF NUMBER & MFR CODE	U/M		
99	18	PAFZZ	PAFZZ	PAGZZ	PAFZZ			5940-00-283-5280	TERMINAL, LUG MS25036-106 96906	EA	1	
99	19	PAFZZ	PAFZZ	PAGZZ	PAFZZ			6145-00-578-6605	WIRE, ELECTRICAL MS086-2-16-9 81349	EA	V	
99	20	MFFZZ	MFF	MGZ	MFFZZ				LEAD, ELECTRICAL 72-2868-2 30554 30554-72-2868-2 36024 MANUFACTURE FROM:	EA	1	
99	21	PAFZZ	PAFZZ	PAGZZ	PAFZZ			5940-00-283-5280	TERMINAL, LUG MS25036-106 96906	EA	1	
99	22	PAFZZ	PAFZZ	PAGZZ	PAFZZ			6145-00-578-6605	WIRE, ELECTRICAL MS5086-2-16-9 81349	EA	V	
99	23	MFFZZ	MFF	MGZ	MFFZZ				LEAD, ELECTRICAL 72-2868-6 30554 30554-72-2868-6 36024 MANUFACTURE FROM:	EA	1	
99	24	PAFZZ	PAFZZ	PAGZZ	PAFZZ			5940-00-283-5280	TERMINAL, LUG MS25036-106 96906	EA	2	
99	25	PAFZZ	PAFZZ	PAGZZ	PAFZZ			6145-00-578-6605	WIRE, ELECTRICAL MS086-2-16-9 81349	EA	V	
99	26	MFFZZ	MFF	MGZ	MFFZZ				LEAD, ELECTRICAL 72-2868-5 30554 30554-72-2868-5 36024 MANUFACTURE FROM:	FT	1	
99	27	PAFZZ	PAFZZ	PAGZZ	PAFZZ			5940-00-283-5280	TERMINAL LUG MS25036-106 96906	EA	2	
99	28	PAFZZ	PAFZZ	PAGZZ	PAFZZ			6145-00-578-6605	WIRE, ELECTRICAL MS5086-2-16-9 81349	FT	V	
99	29	PAFZZ	PAFZZ	PAGZZ	PAFZZ				CIRCUIT BREAKER 72-2807 30554 JM15AWD 15605	EA	1	
99	30	PAFZZ	PAFZZ	PAGZZ	PAFZZ			5930-00-375-0139	SWITCH 70-1290 30554 24903LW 82121	EA	1	
99	31	PAFZZ	PAFZZ	PAGZZ	PAFZZ			5310-00-934-9747	NUT, PLAIN, HEXAGON; TRANSFORMER MTG MS35649-262 96906	EA	4	
99	32	PAFZZ	PAFZZ	PAGZZ	PAFZZ			5305-00-036-6968	SCREW, WASHER; TRANSFORMER MTG P15121-18 45722	EA	4	
99	33	PAFZZ	PAFZZ	PAGZZ	PAFZZ			5950-00-600-0845	TRANSFORMER 72-2821 30554 30554-72-2821 36024	EA	1	
99	34	PAFZZ	PAFZZ	XBGZZ	PAFZZ				LIGHT, INDICATOR 70-1292 30554 80-0901-0511-203 72619	EA	1	
99	35	PAOZZ	PAOZZ	PAOZZ	PAOZZ			6240-00-143-3049	LAMP, INCANDESCENT MS15579-4 96906	EA	1	
99	36	XBFZZ	XB	XBGZZ	XBFZZ				COVER 72-2800 30554 30554-72-2800 38024	EA	1	

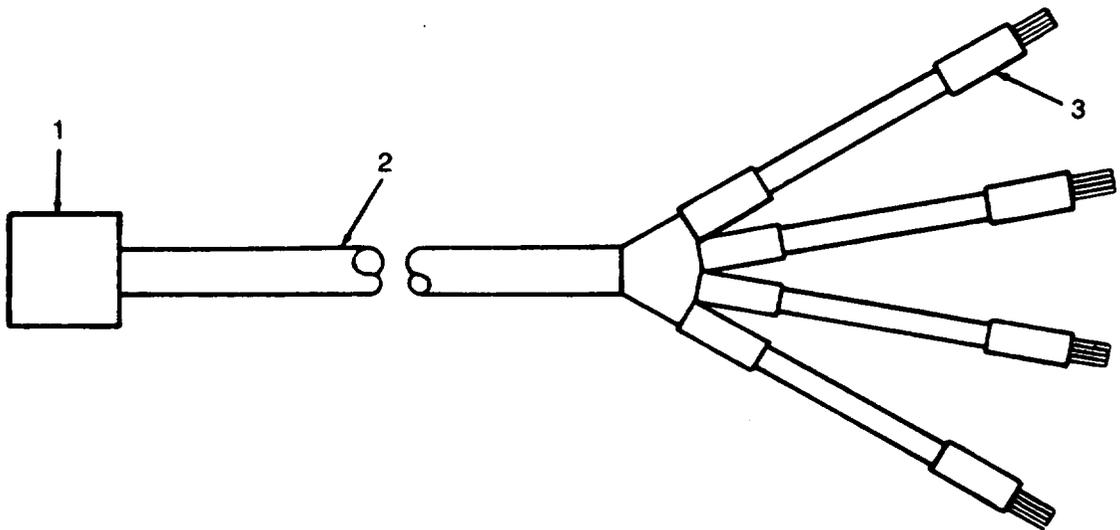

Figure 100. Load bank power wiring harness.

TM9-6115-465-24P
 TO35CZ-3-446-4
 NAVFACP-8-625-24P
 SL-4-06858B/06859D

(1) ILLUSTRATION A	(2) SMR CODE A	(2) SMR CODE B	(2) SMR CODE C	(2) SMR CODE D	(3) A	(3) B	(4) NATIONAL STOCK NUMBER	(5) DESCRIPTION REF NUMBER & MFR CODE	(6) USABLE ON CODE	(7) QTY INC IN UNITS	(8) USMC QTY PER EQUIP
FIG. NO.	ITEM NO.	ARMY	AIR FORCE	NAVY	USMC	SSI	REPL FACTOR		U/M		
100		PAFZZ	PAOZZ	PBGGG	PAFZZ			6115-00-610-2128 WIRING HARNESS, LOAD BANK POWER 72-2829 30554 30554-72-2829 36024	EA	1	
100	1	XAFZZ	XA	XAGZZ	PAFZZ			5935-00-839-9681 CONNECTOR, PLUG MS3106R32-17S 96906	EA	1	
100	2	XAFZZ	XA	XAGZZ	XAFZZ			CABLE, ELECTRICAL CO-04HDF4-18-0415	FT	V	
100	3	XAFZZ	XA	XBGZZ	XAFZZ			INSULATION SLEEVING MILI23053-5CLASS13 81349	FT	V	

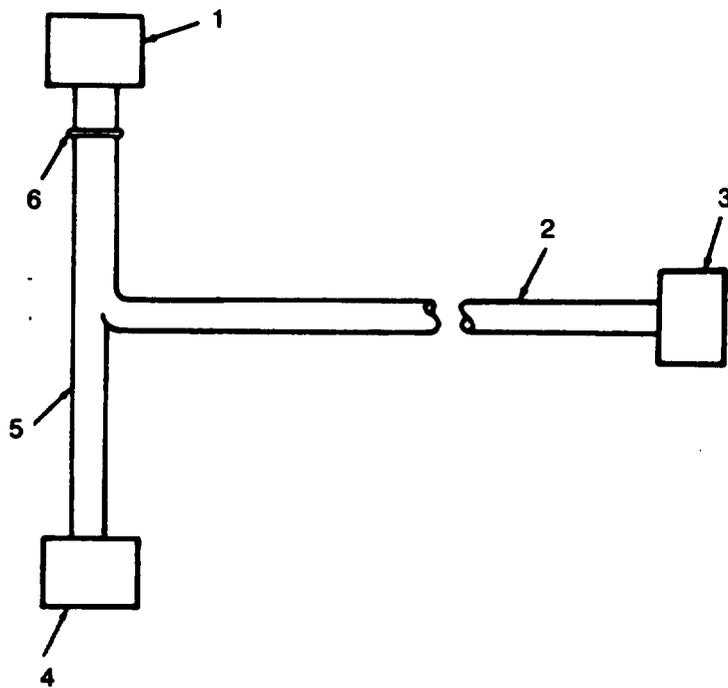

Figure 101. Load bank signal wiring harness.

TM9-6115-465-24P
 TO35CZ-3-446-4
 NAVFACP-8-625-24P
 SL-4-06858B/06859D

(1) ILLUSTRATION		(2) SMR CODE				(3)		(4) NATIONAL STOCK NUMBER	(5) DESCRIPTION	(6) USABLE ON CODE	(7) QTY INC IN UNITS	(8) USMC QTY PER EQUIP
A FIG. NO.	B ITEM NO.	A ARMY	B AIR FORCE	C NAVY	D USMC	A SSI	B REPL FACTOR	REF NUMBER & MFR CODE	U/M			
101		PAFZZ	PAOZZ	PBGGG	PAFZZ			6115-00-610-2142	WIRING HARNESS, LOAD BANK SIGNAL 72-2830 30554	EA	1	
101	1	XAFZZ	XA	XAGZZ	XAFZZ				PLUG, CABLE 72-2805 30554	EA	1	
101	2	XAFZZ	XA	XAGZZ	XAFZZ				CABLE, ELECTRICAL CO-04HDF4-18-0415 81349	FT	V	
101	3	XAFZZ	PAOZZ	XAFZZ	PAFZ			5935-00-211-0783	CONNECTOR, PLUG MSA3106-F18-4S 96906	EA	2	
101	4	XAFZZ	XAB	XAGZZ	PAFZZ			5934-00-172-8039	CONNECTOR, ELECTRICAL MS3106F20-29S 96906	EA	1	
101	5	XAFZZ	XA	XAGZZ	PAFZZ			6145-00-578-6605	WIRE, ELECTRICAL M5086-2-16-9 81348	FT	V	
101	6	XAFZZ	XA	XAGZZ	PAFZZ			5975-00-727-5153	STRAP, CABLE MS3367-4-9 96906	EA	V	
101		XAFZZ	XA	XAGZZ	XAFZZ				WIRE, COPPER QQW343TYPESSIZE18A 81349	FT	V	

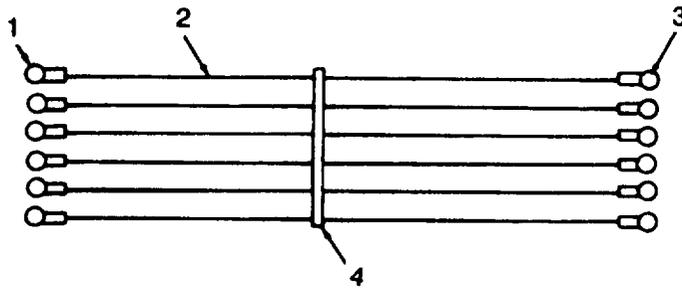

Figure 102. Control box wiring harness.

TM9-6115-465-24P
 TO35CZ-3-446-4
 NAVFACP-8-625-24P
 SL-4-06858B/06859D

(1) ILLUSTRATION		(2) SMR CODE				(3)		(4) NATIONAL STOCK NUMBER	(5) DESCRIPTION	(6) USABLE ON CODE	(7) QTY INC IN UNITS	(8) USMC QTY PER EQUIP
A FIG. NO.	B ITEM NO.	A ARMY	B AIR FORCE	C NAVY	D USMC	A SSI	B REPL FACTOR	REF NUMBER & MFR CODE	U/M			
102		MFFZZ	MFO	AGGGG	MFFZZ			WIRING HARNESS, CONTROL BOX 72-2872 30554 30554-72-2872 36024 MANUFACTURE FROM:	EA	1		
102	1	PAFZZ	PAOZZ	PAGZZ	PAFZZ			5940-00-143-4775 TERMINAL, LUG MS25036-156 96906	EA	6		
102	2	PAFZZ	PAOZZ	PAGZZ	PAFZZ			6145-00-578-7513 WIRE, ELECTRICAL M5086-2-10-9 81349	FT	V		
102	3	PAFZZ	PAOZZ	PAGZZ	PAFZZ			5940-00-143-4794 TERMINAL, LUG MS25036-112 96906	EA	6		
102	4	PAFZZ	PAOZZ	PAGZZ	PAFZZ			5975-00-727-5153 STRAP, TIE-DOWNS MS3367-4-9 96906	EA	V		

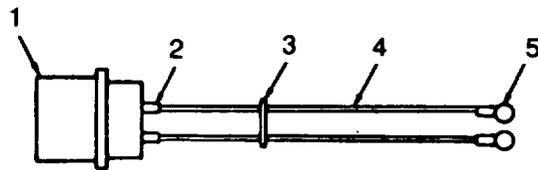

Figure 103. Control box wiring harness.

TM9-6115-465-24P
 TO35CZ-3-446-4
 NAVFACP-8-625-24P
 SL-4-06858B/06859D

(1) ILLUSTRATION		(2) SMR CODE				(3)		(4) NATIONAL STOCK NUMBER	(5) DESCRIPTION	(6) USABLE ON CODE	(7) QTY INC IN UNITS	(8) USMC QTY PER EQUIP
A FIG. NO.	B ITEM NO.	A ARMY	B AIR FORCE	C NAVY	D USMC	A SSI	B REPL FACTOR	REF NUMBER & MFR CODE		U/M		
103		MFFZZ	MFO	AGGGG	MFFZZ			WIRING HARNESS, CONTROL BOX 72-2871 30554 30554-72-2871 36024 MANUFACTURE FROM:		EA	1	
103	1	PAFZZ	PAOZZ	PAGZZ	PAFZZ			5935-00-801-6617 CONNECTOR, RECEPTACLE MS3102R18-4P 96906		EA	1	
103	2	PAFZZ	POAZZ	XBGZZ	PAFZZ			5970-00-914-3117 INSULATION, SLEEVEING MILI23053-5CLASS1- 81349		FT	V	
103	3	PAFZZ	PAOZZ	PAGZZ	PAFZZ			5975-00-727-5153 STRAP, TIE-DOWN MS3367-4-9 96906		EA	V	
103	4	PAFZZ	PAOZZ	PAGZZ	PAFZZ			6145-00-578-6605 WIRE, ELECTRICAL M5086-2-16-9 81349		FT	V	
103	5	PAFZZ	PAOZZ	PAGZZ	PAFZZ			5940-00-283-5280 TERMINAL, LUG MS25036-106 96906		EA	4	

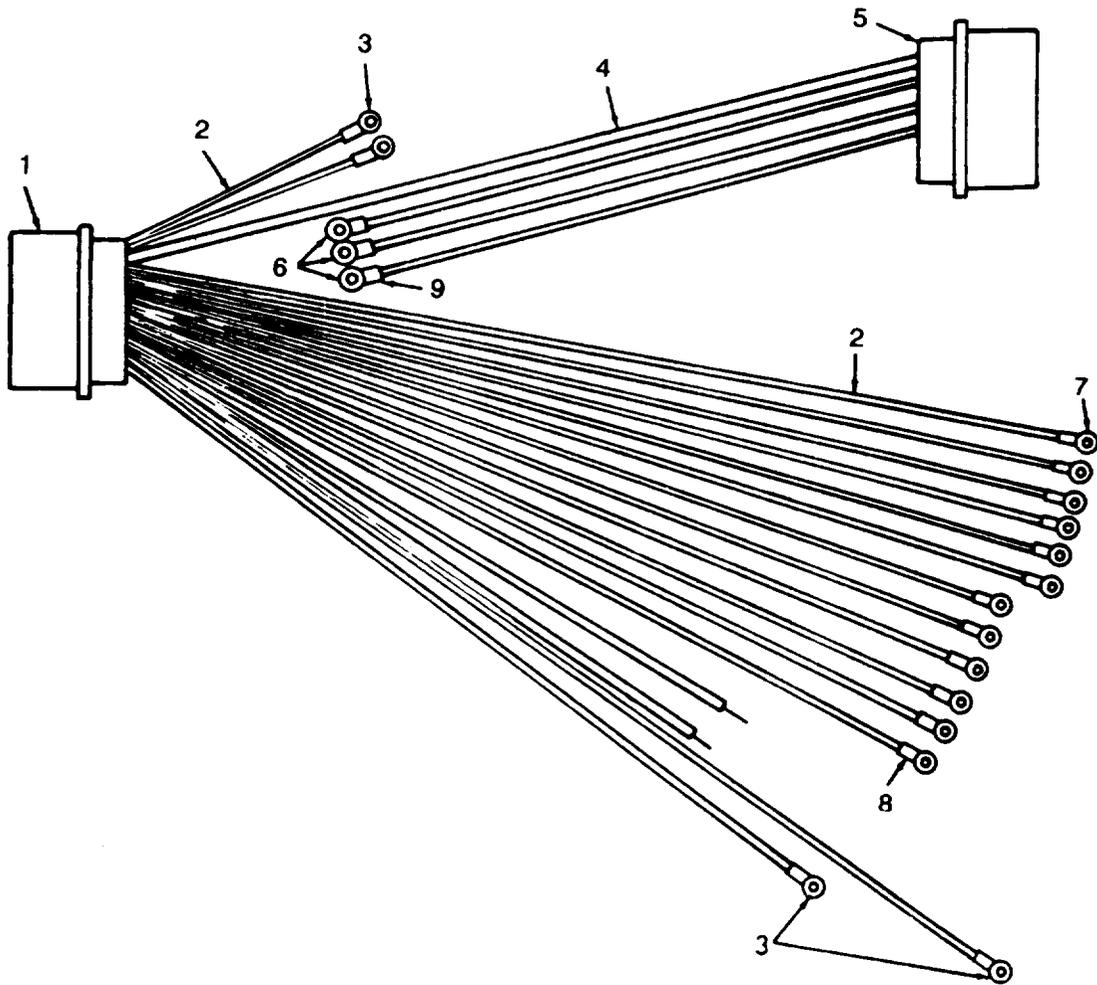

Figure 104. Control box branched wiring harness.

TM9-6115-465-24P
 TO35CZ-3-446-4
 NAVFACP-8-625-24P
 SL-4-06858B/06859D

(1) ILLUSTRATION		(2) SMR CODE				(3)		(4) NATIONAL STOCK NUMBER	(5) DESCRIPTION	(6) USABLE ON CODE	(7) QTY INC IN UNITS	(8) USMC QTY PER EQUIP
A FIG. NO.	B ITEM NO.	A ARMY	B AIR FORCE	C NAVY	D USMC	A SSI	B REPL FACTOR	REF NUMBER & MFR CODE	U/M			
104		MFFZZ	MFO	AGGGG	MFFZZ			WIRING HARNESS, CONTROL BOX BRANCHED 72-2828 30554 30554-72-2828 36024 MANUFACTURE FROM:	EA	1		
104	1	PAFZZ	PAOZZ	PAGZZ	PAFZZ			5935-00-806-4587 CONNECTOR, RECEPTACLE MS3102R32-6P 96906	EA	1		
104	2	PAFZZ	PAOZZ	PAGZZ	PAFZZ			6145-00-578-6605 WIRE, ELECTRICAL M5086-2-8-9 81349	FT	V		
104	3	PAFZZ	PAOZZ	PAGZZ	PAFZZ			5940-00-283-5280 TERMINAL, LUG MS25036-106 96906	EA	4		
104	4	PAFZZ	PAOZZ	PAFZZ	PAFZZ			6145-00-578-6605 WIRE, ELECTRICAL M5086-216-9 81349	FT	V		
104	5	PAFZZ	PAOZZ	PAGZZ	PAFZZ			5935-00-834-6220 CONNECTOR, RECEPTACLE MS3102R32-17P 96906	EA	1		
104	6	PAFZZ	PAOZZ	PAGZZ	PAFZZ			5940-00-114-1310 TERMINAL, LUG MS25036-115 96906	EA	9		
104	7	PAFZZ	PAOZZ	PAGZZ	PAFZZ			5940-00-143-4774 TERMINAL, LUG MS25036-153 96906	EA	12		
104	8	PAFZZ	PAOZZ	XBGZZ	PAFZZ			5970-00-914-3117 INSULATION, SLEEVING MILI23053-5CLASS1- 81349 093X187X0201N	FT	V		
104	9	PAFZZ	PAOZZ	XBGZZ	PAFZZ			5970-00-914-3118 INSULATION, SLEEVING MILI23053-5CLASS1- 81349 250X500X02501N	FT	V		

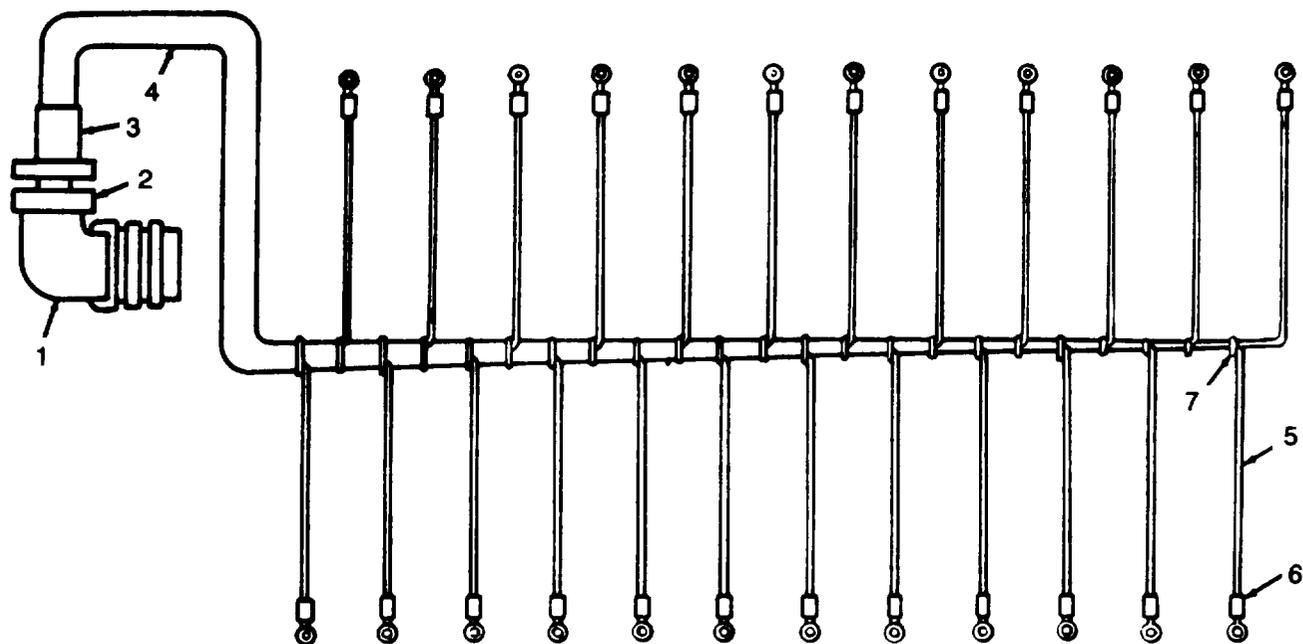

Figure 105. Bottom load bank wiring harness.

TM9-6115-465-24P
 TO 35C2-3-446-4
 NAVFAC P-8-446-4
 SL-4-06858B/06859D

(1) ILLUSTRATION		(2) SMR CODE				(3)		(4) NATIONAL STOCK NUMBER	(5) DESCRIPTION	(6) USABLE ON CODE	(7) QTY INC IN UNITS	(8) USMC QTY PER EQUIP
A FIG. NO.	B ITEM NO.	A ARMY	B AIR FORCE	C NAVY	D USMC	A SSI	B REPL FACTOR	REF NUMBER & MFR CODE	U/M			
105		MFFZZ	MFO	AGGGG	MFFZZ			WIRING HARNESS 72-2825 30554 30554-72-2825 36024 MANUFACTURE FROM:	EA	1		
105	1	PAFZZ	PAOZZ	PAGZZ	PAFZZ			5935-00-806-3564 CONNECTOR, PLUG MS3108R28-12S 96906	EA	1		
105	2	PAFZZ	PAOZZ	XBGZZ	PAFZZ			5935-00-280-2353 CLAMP, CABLE MS3057-16A 96906	EA	1		
105	3	PAFZZ	PAOZZ	PAGZZ	PAFZZ			5365-00-141-6943 BUSHING, CABLE MS3420-16 96906	EA	1		
105	4	PAFZZ	PAOZZ	XBGZZ	PAFZZ			5970-00-914-3117 INSULATION SLEEVING MILI23053-5CLASS1- 81349	FT	V		
105	5	PAFZZ	PAOZZ	XBGZZ	PAFZZ			6145-00-578-6605 WIRE, ELECTRICAL M22759-6-16-9 81349	FT	V		
105	6	PAFZZ	PAOZZ	PAGZZ	PAFZZ			5940-00-107-1481 TERMINAL, LUG MS20659-104 96906	EA	24		
105	7	PAFZZ	PAOZZ	PAGZZ	PAFZZ			5975-00-727-5153 STRAP, TIE-DOWN MS3367-5-9 96906	EA	V		
105		PAFZZ	PAOZ	XBGZZ	PAFZZ			5340-00-823-5322 PLUG, END SEAL MS25251-16 96906	EA	2		

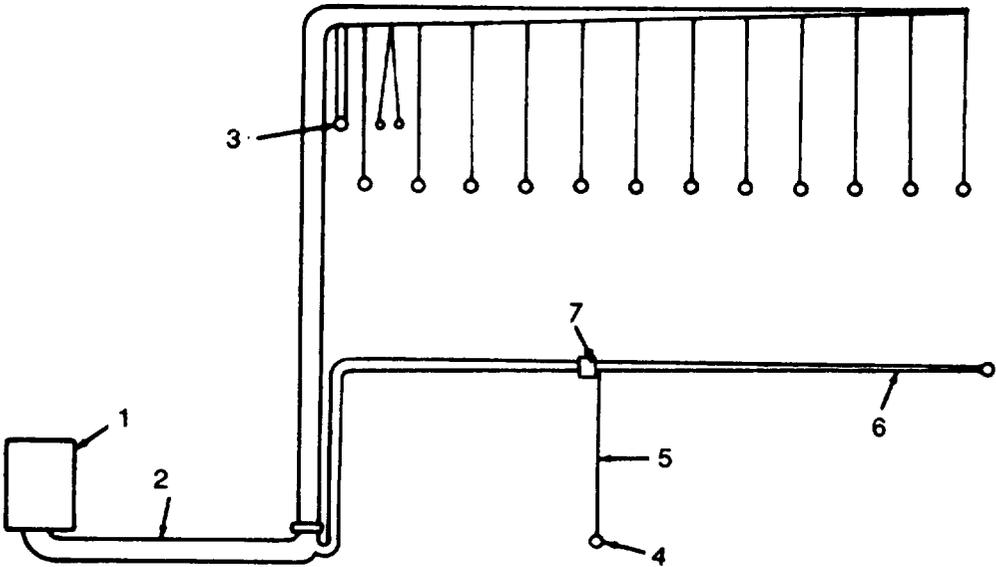

Figure 106. Load bank wiring harness.

TM9-6115-465-24P
 TO35CZ-3-446-4
 NAVFACP-8-625-24P
 SL-4-06858B/06859D

(1) ILLUSTRATION		(2) SMR CODE				(3)		(4) NATIONAL STOCK NUMBER	(5) DESCRIPTION	(6) USABLE ON CODE	(7) QTY INC IN UNITS	(8) USMC QTY PER EQUIP
A FIG. NO.	B ITEM NO.	A ARMY	B AIR FORCE	C NAVY	D USMC	A SSI	B REPL FACTOR	REF NUMBER & MFR CODE	U/M			
106		MFFZZ	MFO	AGGGG	MFFZZ			WIRING HARNESS, LOAD BANK 72-2823 30554 30554-72-2823 36024 MANUFACTURE FROM:	EA	1		
106	1	PAFZZ	PAOZZ	XBGZZ	PAFZZ			5935-00-368-2353 CONNECTOR, PLUG MS3106F32-6S 96906	EA	1		
106	2	PAFZZ	PAOZZ	XBGZZ	PAFZZ			5970-00-914-3118 INSULATION SLEEVING MILI23053-5CLASS1- 81349	FT	V		
106	3	PAFZZ	PAOZZ	PAGZZ	PAFZZ			5940-00-114-1310 TERMINAL, LUG MS20659-130 96906	EA	1		
106	4	PAFZZ	PAOZZ	PAGZZ	PAFZZ			5940-00-143-4780 TERMINAL, LUG MS20659-104 96906	EA	16		
106	5	PAFZZ	PAOZZ	XBGZZ	PAFZZ			WIRE, ELECTRICAL MS17412-6 96906	FT	V		
106	6	PAFZZ	PAOZZ	XBGZZ	PAFZZ			WIRE, ELECTRICAL MS17412-16 96906	FT	V		
106	7	PAFZZ	PAOZZ	PAGZZ	PAFZZ			5975-00-111-3208 STRAP, TIE-DOWN MS3367-5-9 96906	EA	V		
106		PAFZZ	PAOZZ	XBGZZ	PAFZZ			5935-01-565-9497 PLUG END SEAL MS25251-8 96906	EA	3		

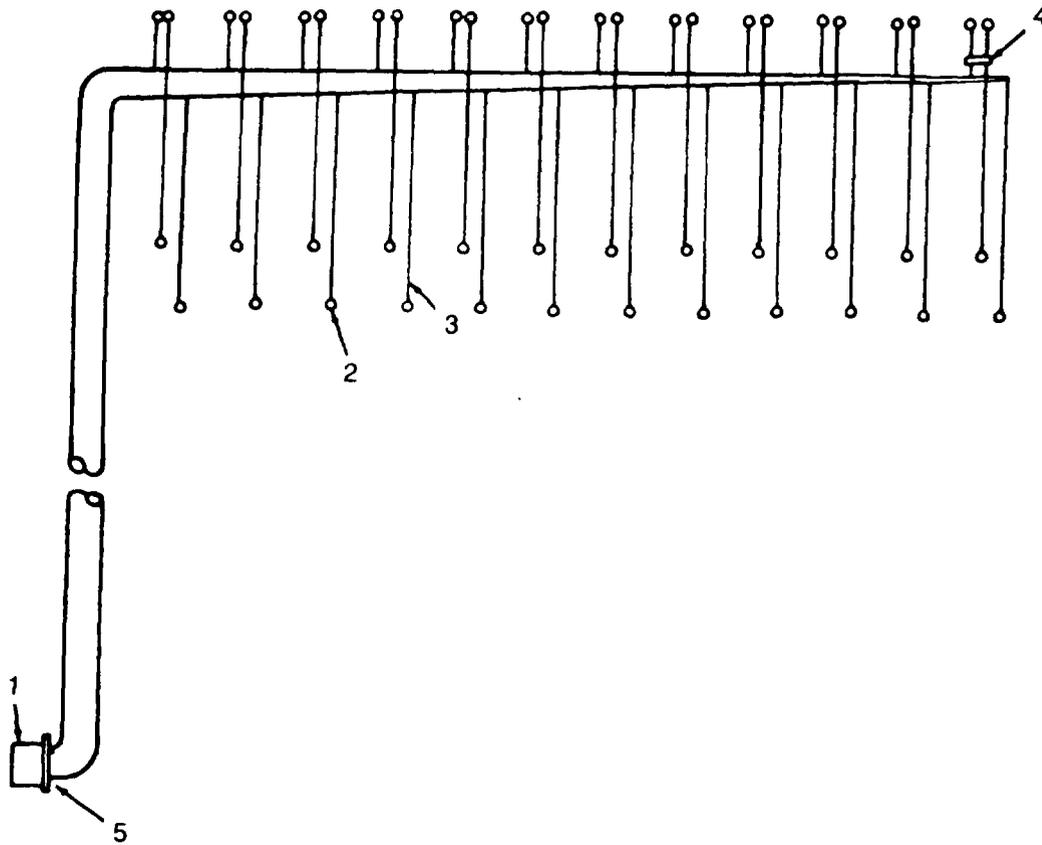

Figure 107. Top load bank wiring harness.

TM9-6115-465-24P
 TO35CZ-3-446-4
 NAVFACP-8-625-24P
 SL-4-06858B/06859D

(1) ILLUSTRATION		(2) SMR CODE				(3)		(4) NATIONAL STOCK NUMBER	(5) DESCRIPTION	(6) USABLE ON CODE	(7) QTY INC IN UNITS	(8) USMC QTY PER EQUIP
A FIG. NO.	B ITEM NO.	A ARMY	B AIR FORCE	C NAVY	D USMC	A SSI	B REPL FACTOR	REF NUMBER & MFR CODE		U/M		
107		MFFZZ	MFO	AGGGG	MFFZZ			WIRING HARNESS, TOP LOAD BANK 72-2822 30554 30554-72-2822 36024 MANUFACTURE FROM:		EA	1	
107	1	PAFZZ	PAOZZ	PAGZZ	PAFZZ			5935-00-725-0888 CONNECTOR, ELECTRICAL MS3102R28-12P 96906		EA	1	
107	2	PAFZZ	PAOZZ	PAGZZ	PAFZZ			5940-00-143-4780 TERMINAL, LUG MS20659-104 96906		EA	48	
107	3	PAFZZ	PAOZZ	XBGZZ	PAFZZ			6145-00-620-5585 WIRE, ELECTRICAL M22759/6-16-9 81349		FT	V	
107	4	PAFZZ	PAOZZ	PAGZZ	PAFZZ			5975-00-727-5153 STRAP, TIE-DOWN MS3367-5-9 96906		EA	V	
107	5	XBFZZ	PAOZZ	XBGZZ	PAFZZ			5970-00-914-3118 INSULATION SLEEVING MIL123053-5CLASS1 81349		FT	V	

SECTION III. SPECIAL TOOLS LIST

(NOT APPLICABLE)

SECTION IV. NATIONAL STOCK NUMBER AND REFERENCE INDEX

STOCK NUMBER	FIG. No.	ITEM No.	STOCK NUMBER	FIG. No.	ITEM No.
1650-00-288-6908	56	11	2815-00-678-6083	77	42
2520-00-477-5996	59	29	2815-00-718-4830	78	10
2520-00-771-5276	63	34	2815-00-738-7924	83	8
2530-00-175-9637	97	57	2815-00-871-6756	77	29
2530-00-408-9176	97	70	2815-00-898-4887	81	7
2530-00-425-8300	97	52	2815-00-898-4889	81	12
2530-00-589-8537	97	19	2815-00-898-4890	81	11
2530-00-602-2544	97	56	2815-00-898-4891	81	10
2530-00-613-6061	97	43	2815-00-903-3566	77	32
2530-00-759-1967	97	35	2815-00-904-7478	81	
2530-00-759-1968	97	50	2815-00-921-5366	64	4
2530-00-871-6901	97	79	2815-00-921-5366	64	85
2530-00-873-4384	97	44	2815-00-922-0179	77	40
2530-00-873-4385	97	45	2815-00-928-8867	77	31
2530-00-873-5318	97	78	2815-00-938-5811	81	
2530-00-883-1098	97	37	2815-00-938-8045	81	15
2530-00-883-1099	97	36	2815-00-945-1143	76	8
2530-00-947-3935	97	34	2815-00-961-1660	77	15
2530-00-024-8328	97	17	2815-00-961-1674	77	33
2540-00-122-2059	90	47	2815-00-961-1675	77	35
2540-00-122-2096	90	22	2815-00-961-4573	77	30
2540-00-122-2098	90	18	2815-00-961-7876	83	36
2540-00-122-2114	90	48	2815-00-972-7178	77	28
2540-00-454-0665	90	65	2815-00-026-2045	65	2
2610-00-414-6458	97	8	2910-00-066-2499	68	1
2610-00-444-7575	97	9	2910-00-085-5598	48	
2805-00-044-0617	77	23	2910-00-085-8621	66	6
2805-00-277-2943	81	9	2910-00-127-5075	68	17
2805-00-369-8782	83	3	2910-00-133-9877	73	11
2805-00-567-8003	79	1	2910-00-141-9758	84	7
2805-00-905-5861	77	27	2910-00-148-6552	70	3
2805-00-425-7901	77	18	2910-00-148-6555	69	20
2815-00-012-2280	78	9	2910-00-148-6557	68	27
2815-00-085-5577	77	6	2910-00-200-3294	70	8
2815-00-133-0815	82	6	2910-00-204-9549	68	20
2815-00-133-0816	83		2910-00-204-9550	68	16
2815-00-133-4828	81		2910-00-208-6974	69	22
2815-00-133-4828	81	26	2910-00-209-1528	72	1
2815-00-226-7940	46	3	2910-00-209-4997	47	3
2815-00-230-3498	81	6	2910-00-212-9065	53	46
2815-00-270-3435	77	26	2910-00-222-2216	48	14
2815-00-460-3268	77		2910-00-287-1912	48	7
2815-00-477-6001	75	7	2910-00-287-1912	49	8
2815-00-501-7001	65	1	2910-00-321-8737	69	8
2815-00-614-6481	83		2910-00-335-9301	68	8
2815-00-614-6484	77	20	2910-00-335-9329	67	11
2815-00-614-6553	80	25	2910-00-383-5134	70	13
2815-00-614-6559	78	4	2910-00-405-6153	47	16
2815-00-614-6561	81	23	2910-00-420-4802	78	18
2815-00-628-0386	77	1	2910-00-454-0666	86	8
2815-00-678-6082	77	43	2910-00-454-0666	86	14

SECTION IV. NATIONAL STOCK NUMBER AND REFERENCE INDEX (CONT.)

STOCK NUMBER	FIG. No.	ITEM No.	STOCK NUMBER	FIG. No.	ITEM No.
2910-00-454-0666	86	15	2910-01-019-4565	66	7
2910-00-454-0666	86	16	2910-01-025-0457	72	5
2910-00-454-0666	90	25	2910-01-035-1355	66	
2910-00-454-0668	90	23	2910-01-054-3816	66	18
2910-00-499-0818	67	6	2910-01-095-7595	50	6
2910-00-606-0998	65	15	2910-01-134-4520	79	13
2910-00-009-9774	65	11	2910-01-181-2461	49	
2910-00-609-9775	65	12	2910-01-241-7508	84	26
2910-00-609-9779	65	13	2920-00-064-8946	64	19
2910-00-609-9780	65	14	2920-00-133-3295	58	51
2910-00-611-5171	65	10	2920-00-133-9888	58	16
2910-00-615-8587	24	7	2920-00-502-1243	64	12
2910-00-658-3499	65	18	2920-00-565-9739	57	39
2910-00-658-3499	65	21	2920-00-737-3225	64	64
2910-00-658-3499	65	24	2920-00-839-1864	64	43
2910-00-752-9138	84	12	2920-00-865-8270	64	70
2910-00-757-1680	73	14	2920-00-865-8270	64	78
2910-00-780-0938	70	9	2920-00-932-9730	64	68
2910-00-786-1547	72	29	2920-01-011-5439	57	16
2910-00-786-1565	70	11	2920-01-011-6467	57	28
2910-00-786-6343	71	5	2920-01-011-9357	57	24
2910-00-787-6422	73	7	2920-01-014-4070	57	36
2910-00-787-6428	71	16	2920-01-013-5802	57	
2910-00-787-0989	68	24	2920-01-024-9414	57	34
2910-00-830-0154	49	10	2920-01-029-6722	57	23
2910-00-832-0122	67	19	2920-01-054-3814	64	56
2910-00-887-1546	72	19	2920-01-054-3894	64	7
2910-00-887-1547	72	18	2920-01-058-1026	64	74
2910-00-887-1548	72	21	2920-01-105-2053	64	
2910-00-887-1564	72	20	2920-01-208-0805	58	
2910-00-894-6410	66	9	2930-00-034-3802	51	63
2910-00-897-2459	67	18	2930-00-052-3545	90	
2910-00-897-2461	69	2	2930-00-192-9266	51	48
2910-00-897-2466	70	10	2930-00-215-4065	80	29
2910-00-897-2545	68	9	2930-00-392-4724	74	26
2910-00-898-4926	69	4	2930-00-401-9422	51	46
2910-00-898-4927	69	5	2930-00-487-8900	51	27
2910-00-901-0749	69	9	2930-00-557-9704	74	24
2910-00-901-0753	69	17	2930-00-572-6148	51	56
2910-00-932-4787	71	11	2930-00-678-3818	83	
2910-00-971-5568	66	11	2930-00-718-4727	74	23
2910-00-980-2301	71	7	2930-00-720-2677	51	28
2910-01-005-5108	70	7	2930-00-776-0491	51	62
2910-01-005-5117	71	8	2930-00-786-1544	74	25
2910-01-005-5118	71	13	2930-00-806-0776	74	27
2910-01-005-5986	72	15	2930-00-855-5403	74	
2910-01-005-6242	70	5	2930-00-860-0341	51	67
2910-01-005-7064	73	15	2930-00-915-5360	74	9
2910-01-014-4647	66	13	2930-01-004-0012	51	
2910-01-019-2221	66	8	2930-01-013-1768	74	
			2930-01-024-8654	74	3

SECTION IV. NATIONAL STOCK NUMBER AND REFERENCE INDEX (CONT.)

STOCK NUMBER	FIG. No.	ITEM No.	STOCK NUMBER	FIG. No.	ITEM No.
2930-01-024-9627	51	32	3110-00-198-2170	97	24
2930-01-031-2955	63	18	3110-00-244-2865	57	42
2940-00-463-1362	24	5	3110-00-596-3415	80	21
2990-00-580-6304	63	37	3110-00-902-1649	59	24
2940-00-720-4959	63	26	3110-01-015-5398	61	8
2990-00-014-5626	90	12	3110-01-017-5579	57	38
2990-00-021-5241	53	27	3120-00-106-8645	53	3
2990-00-135-6416	59	20	3120-00-106-8645	54	12
2990-00-136-6418	59	28	3120-00-212-0061	53	21
2990-00-135-6419	59	27	3120-00-472-8343	88	11
2990-00-135-6420	59	30	3120-00-492-9096	80	28
2990-00-135-6427	90		3120-00-547-4349	51	64
2990-00-161-7700	90	69	3120-00-625-8472	40	6
2990-00-211-5066	53	49	3120-00-678-6087	82	7
2990-00-211-5086	53	23	3120-00-857-0630	64	76
2990-00-211-5249	53		3120-00-857-0630	83	
2990-00-211-5258	53	11	3120-00-857-1043	83	51
2990-00-216-9983	53		3120-00-886-6208	72	
2990-00-405-6146	53		3120-00-902-2183	64	71
2990-00-429-0524	65	31	3120-00-909-6148	81	5
2990-00-459-7135	69	16	3120-00-917-1858	81	3
2990-00-477-6143	90	64	3120-00-917-5966	82	8
2990-00-477-6153	90	1	3120-01-014-8979	83	52
2990-00-611-5615	2	11	3120-01-015-0714	83	53
2990-00-614-6785	8	80	3120-01-051-2619	64	8
3020-00-207-9284	58	3	3130-00-618-2260	40	4
3020-00-615-8585	59	7	4020-00-141-7152	8	27
3020-00-623-9196	74	19	4020-00-270-8245	87	12
3020-00-678-6094	81	24	4020-00-928-3438	14	4
3020-00-938-5766	79	4	4030-00-410-0561	97	73
3020-00-938-5768	78	17	4030-00-780-9350	8	25
3020-01-025-6532	78	20	4030-00-780-9350	87	10
3020-01-025-4952	80	22	4210-00-138-2249	90	33
3020-01-026-1260	57	33	4210-00-138-2250	90	35
3020-01-014-0211	82	2	4210-00-138-2251	90	67
3020-01-044-3758	81	24	4210-00-138-2252	90	60
3020-01-100-7976	80	17	4310-00-138-2253	90	61
3020-01-118-1072	80	20	4210-00-138-2254	90	43
3020-01-203-9895	78	19	4310-00-614-9461	64	57
3030-01-756-8416	57	7	4320-00-308-0343	78	
3040-01-006-5303	8	79	4320-00-576-3557	92	25
3040-01-011-6347	78	21	4320-00-607-7663	92	
3040-01-025-0511	61	16	4330-00-542-2060	56	13
3040-01-025-4146	78	23	4330-00-724-1463	63	36
3110-00-050-1666	61	14	4520-00-014-5627	90	16
3110-00-100-0542	97	27	4520-00-625-2977	97	55
3110-00-100-3537	97	26	4540-00-282-8181	92	27
3110-00-123-2583	58	7	4710-00-278-8726	55	6
3110-00-130-7718	58	17	4710-00-350-9897	65	30
3110-00-141-9994	40	5	4710-00-457-7018	90	20
3110-00-198-2169	97	23	4710-00-640-5410	86	7

SECTION IV. NATIONAL STOCK NUMBER AND REFERENCE INDEX (CONT.)

STOCK NUMBER	FIG. No.	ITEM No.	STOCK NUMBER	FIG. No.	ITEM No.
4710-00-643-5410	85	10	4730-00-063-7919	51	15
4710-00-643-5410	85	12	4730-00-063-9672	65	27
4710-00-643-5410	85	19	4730-00-088-8901	55	18
4710-00-643-1579	65	23	4730-00-103-2212	51	15
4710-00-730-1581	65	20	4730-00-103-2212	51	17
4710-00-804-9249	47	1	4730-00-113-0567	85	38
4710-00-983-0057	65	17	4730-00-121-0138	85	22
4710-01-025-4687	65	28	4730-00-141-1092	85	36
4720-00-139-4105	90	37	4730-00-141-1094	88	8
4720-00-203-2636	92	9	4730-00-177-6166	88	22
4720-00-278-1323	55	3	4730-00-196-1497	84	4
4720-00-278-1323	55	9	4730-00-200-3412	67	10
4720-00-278-1323	55	13	4730-00-202-6491	51	19
4720-00-278-4892	86		4730-00-209-1759	75	12
4720-00-278-4892	51		4730-00-222-1837	88	23
4720-00-289-4476	55	7	4730-00-246-9218	84	6
4720-00-289-9197	63	12	4730-00-266-0531	65	32
4720-00-289-9197	85	17	4730-00-277-8257	74	11
4720-00-289-9197	85	7	4730-00-278-3397	83	14
4720-00-289-9197	85	17	4730-00-278-3983	88	28
4720-00-289-9197	87	6	4730-00-278-4892	51	
4720-00-289-9197	88	19	4730-00-285-4329	53	47
4720-00-289-5959	84	14	4730-00-287-8437	53	51
4720-00-401-9299	84		4730-00-288-9948	92	6
4720-00-450-6618	88	17	4730-00-289-0094	83	19
4720-00-542-4433	87	6	4730-00-289-4736	63	14
4720-00-542-4433	63	9	4730-00-292-2311	88	20
4720-00-542-4433	88	3	4730-00-294-1508	88	25
4720-00-542-4433	88	16	4730-00-294-1512	92	5
4720-00-542-4433	92	3	4730-00-294-1481	84	1
4720-00-542-4433	92	11	4730-00-324-1481	55	18
4720-00-542-4433	92	16	4730-00-331-4686	92	12
4720-00-609-8732	51	16	4730-00-335-9315	72	22
4720-00-614-6230	51	12	4730-00-359-3103	63	13
4720-00-625-2202	2	2	4730-00-436-7317	90	66
4720-00-627-9773	51	14	4730-00-486-7317	88	4
4720-00-838-7818	92	14	4730-00-437-0040	92	4
4720-00-931-7879	85	5	4730-00-451-6098	55	24
4720-00-997-0316	75	3	4730-00-459-6077	69	1
4720-01-022-3923	85	15	4730-00-529-4958	83	20
4730-00-006-3977	88	6	4730-00-537-1192	49	3
4730-00-010-3875	83	18	4730-00-541-6584	2	1
4730-00-010-3876	83	21	4730-00-580-6406	88	7
4730-00-010-3885	83		4730-00-585-7635	85	13
4730-00-014-4307	65	29	4730-00-585-7635	85	20
4730-00-040-7450	87	7	4730-00-595-4251	65	33
4730-00-044-4577	85	25	4730-00-595-4924	65	8
4730-00-044-4688	64	6	4730-00-603-0731	85	9
4730-00-044-4688	64	69	4730-00-614-6473	55	17
4730-00-044-4688	64	77	4730-00-614-4478	85	27
4730-00-052-9877	65	9	4730-00-618-8497	85	39

SECTION IV. NATIONAL STOCK NUMBER AND REFERENCE INDEX (CONT.)

STOCK NUMBER	FIG. No.	ITEM No.	STOCK NUMBER	FIG. No.	ITEM No.
4730-00-619-9362	85	40	4810-00-216-1849	47	15
4730-00-621-1036	86	6	4810-00-357-0538	47	14
4730-00-778-6206	55	15	4820-00-072-0567	90	
4730-00-801-8186	77	36	4820-00-090-0554	84	5
4730-00-808-3833	97	46	4820-00-136-1085	88	5
4730-00-812-1333	85	26	4820-00-136-1085	92	7
4730-00-812-7999	55	24	4820-00-209-1562	85	34
4730-00-816-6784	55	14	4820-00-277-1765	88	21
4730-00-834-6187	75	13	4820-00-432-1232	71	17
4730-00-842-2201	63	11	4820-00-491-3102	92	20
4730-00-842-2201	85	2	4820-00-595-3191	84	23
4730-00-842-2201	85	6	4820-00-614-6498	59	32
4730-00-842-2201	85	16	4820-00-622-5790	78	
4730-00-842-2201	87	5	4820-00-752-9040	47	17
4730-00-842-2201	88	18	4820-00-752-9040	48	5
4730-00-842-2202	63	5	4820-00-934-7877	88	12
4730-00-842-2202	63	8	4820-01-005-6012	63	32
4730-00-842-2202	63	11	4820-01-025-7632	47	12
4730-00-842-2202	88	2	4820-01-025-9725	78	28
4730-00-842-2202	88	15	5120-00-138-3790	14	5
4730-00-843-2202	92	2	5300-00-343-1451	58	1
4730-00-843-2202	92	10	5310-00-897-6082	20	19
4730-00-843-2202	92	15	5305-00-007-6310	59	21
4730-00-843-0269	55	2	5305-00-021-3668	54	9
4730-00-843-0269	55	8	5305-00-026-2577	57	15
4730-00-843-0269	55	12	5305-00-026-2577	58	32
4730-00-861-6890	49	4	5305-00-036-6897	18	6
4730-00-865-6597	87		5305-00-036-6900	18	4
4730-00-893-6402	50	8	5305-00-036-6901	18	10
4730-00-908-3193	88	33	5305-00-036-6968	1	26
4730-00-908-3193	63	17	5305-00-036-6968	3	2
4730-00-908-6292	92	35	5305-00-036-6968	3	11
4730-00-908-6294	84	13	5305-00-038-6968	7	5
4730-00-909-8627	51	11	5305-00-036-6968	7	7
4730-00-909-8627	51	13	5305-00-036-6968	7	16
4730-00-911-5481		38	5305-00-036-6968	7	21
4730-00-911-5707	92	13	5305-00-036-6968	25	22
4730-00-972-1630	65	26	5305-00-036-6968	27	16
4730-00-982-8853	88	10	5305-00-036-6968	27	26
4730-00-993-3711	75	14	5305-00-036-6968	31	16
4730-00-005-6335	2	1	5305-00-036-6968	31	20
4730-01-005-6945	85	37	5305-00-036-6968	93	21
4730-01-013-9363	75	2	5305-00-036-6968	99	32
4730-01-016-5922	75	1	5305-00-036-6972	93	35
4730-01-019-4018	92	26	5305-00-036-6972	93	46
4730-01-020-5607	85	27	5305-00-036-6972	99	4
4730-01-022-8535	47	2	5305-00-036-6977	7	33
4730-01-024-1311	85	38	5305-00-036-6977	25	8
4730-01-039-6747	85	29	5305-00-036-6977	25	11
4730-01-048-9769	85	24	5305-00-036-6977	25	13
4730-01-100-6990	55	5	5305-00-036-6977	31	17

SECTION IV. NATIONAL STOCK NUMBER AND REFERENCE INDEX (CONT.)

STOCK NUMBER	FIG. No.	ITEM No.	STOCK NUMBER	FIG. No.	ITEM No.
5305-00-036-6977	31	40	5305-00-068-0500	21	1
5305-00-036-6977	31	42	5305-00-068-0500	21	2
5305-00-036-6977	35	1	5305-00-068-0500	21	12
5305-00-036-6979	93	40	5305-00-068-0500	24	3
5305-00-036-6979	4	2	5305-00-068-0500	25	1
5305-00-038-3089	25	24	5305-00-068-0500	27	1
5305-00-038-3089	27	13	5305-00-068-0500	31	11
5305-00-038-3089	27	15	5305-00-068-0500	38	5
5305-00-038-3089	27	45	5305-00-068-0500	38	8
5305-00-038-3089	93	32	5305-00-068-0500	38	11
5305-00-038-3089	93	48	5305-00-068-0500	38	15
5305-00-038-3089	98	24	5305-00-068-0500	44	4
5305-00-038-3089	99	6	5305-00-068-0500	47	5
5305-00-038-3096	47	22	5305-00-068-0500	47	10
5305-00-038-3103	98	12	5305-00-068-0500	51	8
5305-00-038-3122	93	25	5305-00-068-0500	52	1
5305-00-038-3122	93	30	5305-00-068-0500	52	4
5305-00-038-3122	93	42	5305-00-068-0500	84	10
5305-00-042-6417	39	1	5305-00-068-0500	84	15
5305-00-042-6417	50	15	5305-00-068-0500	84	32
5305-00-042-6417	50	21	5305-00-068-0500	93	1
5305-00-042-6417	50	26	5305-00-068-0500	93	3
5305-00-042-6417	50	31	5305-00-068-0500	98	28
5305-00-042-6417	50	36	5305-00-068-0502	1	36
5305-00-042-6417	50	41	5305-00-068-0502	2	3
5305-00-042-6417	54	4	5305-00-068-0502	13	10
5305-00-043-6642	89	17	5305-00-068-0502	13	16
5305-00-058-9365	53	30	5305-00-068-0502	13	21
5305-00-059-4552	3	3	5305-00-068-0502	13	46
5305-00-059-7666	61	1	5305-00-068-0502	13	59
5305-00-068-0498	45	1	5305-00-068-0502	13	86
5305-00-068-0498	45	15	5305-00-068-0502	13	90
5305-00-068-0498	46	1	5305-00-068-0502	22	4
5305-00-068-0498	46	15	5305-00-068-0502	25	7
5305-00-068-0500	5	1	5305-00-068-0502	27	2
5305-00-068-0500	7	2	5305-00-068-0502	50	4
5305-00-068-0500	8	1	5305-00-068-0502	53	7
5305-00-068-0500	13	3	5305-00-068-0502	56	18
5305-00-068-0500	13	28	5305-00-068-0502	85	32
5305-00-068-0500	13	33	5305-00-068-0502	88	36
5305-00-068-0500	13	40	5305-00-068-0502	92	18
5305-00-068-0500	13	52	5305-00-068-0502	98	1
5305-00-068-0500	13	58	5305-00-068-0502	98	4
5305-00-068-0500	13	63	5305-00-068-0502	98	21
5305-00-068-0500	13	66	5305-00-068-5122	35	10
5305-00-068-0500	13	72	5305-00-068-2236	56	10
5305-00-068-0500	13	76	5305-00-068-2237	45	6
5305-00-068-0500	13	80	5305-00-068-2237	46	6
5305-00-068-0500	13	83	5305-00-068-2239	21	25
5305-00-068-0500	13	88	5305-00-068-2239	37	1
5305-00-068-0500	13	93	5305-00-068-2241	54	8

SECTION IV. NATIONAL STOCK NUMBER AND REFERENCE INDEX (CONT.)

STOCK NUMBER	FIG. No.	ITEM No.	STOCK NUMBER	FIG. No.	ITEM No.
5305-00-071-2241	65	4	5305-00-269-3209	13	101
5305-00-071-2511	21	38	5305-00-269-3209	51	3
5305-00-071-2519	41	3	5305-00-269-3209	51	25
5305-00-119-4728	90	9	5305-00-269-3209	78	2
5305-00-125-6181	73	1	5305-00-269-3209	83	38
5305-00-145-4960	8	32	5305-00-269-3210	48	1
5305-00-155-5145	90	31	5305-00-269-3210	49	1
5305-00-156-2937	73	6	5305-00-269-3211	37	8
5305-00-191-6116	89	2	5305-00-269-3211	38	18
5305-00-191-6226	3	1	5305-00-269-3211	45	9
5305-00-191-6226	7	2	5305-00-269-3211	46	9
5305-00-191-6226	13	69	5305-00-269-3211	48	21
5305-00-191-6226	21	22	5305-00-269-3211	49	14
5305-00-191-6226	21	26	5305-00-269-3211	51	21
5305-00-191-6226	21	30	5305-00-269-3211	78	11
5305-00-191-6226	21	34	5305-00-269-3211	80	1
5305-00-191-6226	21	42	5305-00-269-3213	38	22
5305-00-191-6226	21	48	5305-00-269-3214	45	12
5305-00-191-6226	25	4	5305-00-269-3214	46	12
5305-00-191-6226	25	6	5305-00-276-8782	90	14
5305-00-191-6226	27	6	5305-00-363-9695	83	43
5305-00-191-6226	31	4	5305-00-397-4708	18	40
5305-00-191-6226	84	19	5305-00-397-4710	18	79
5305-00-191-6226	88	27	5305-00-397-4712	18	84
5305-00-191-6226	88	30	5305-00-410-3007	90	6
5305-00-191-6226	92	23	5305-00-446-7317	90	57
5305-00-191-6226	99	1	5305-00-500-3542	18	62
5305-00-207-3984	72	12	5305-00-531-0298	53	31
5305-00-207-8253	53	2	5305-00-543-2732	53	52
5305-00-211-9344	89	3	5305-00-579-2138	53	42
5305-00-224-1092	4	3	5305-00-579-2139	22	37
5305-00-225-3839	23	2	5305-00-579-2139	22	42
5305-00-225-3839	53	13	5305-00-579-2139	22	47
5305-00-225-8503	80	18	5305-00-582-3601	37	15
5305-00-225-9081	57	1	5305-00-582-5807	22	60
5305-00-225-9081	57	3	5305-00-582-5807	35	22
5305-00-228-7508	18	54	5305-00-614-0260	53	57
5305-00-231-1517	18	65	5305-08-616-5649	75	16
5305-00-231-1535	18	52	5305-00-616-5649	80	2
5305-00-231-1535	18	18	5305-00-616-5649	80	11
5305-00-231-1572	18	21	5305-00-619-2322	74	20
5305-00-250-5613	70	28	5305-00-622-9475	35	12
5305-00-253-3437	90	2	5305-00-623-1653	63	19
5305-00-253-3437	90	29	5305-00-629-3209	13	106
5305-00-253-5603	53	61	5305-00-630-4811	77	16
5305-00-253-5606	73	4	5305-00-638-8859	68	12
5305-00-253-5615	18	1	5305-00-709-8540	48	3
5305-00-253-5616	38	24	5305-00-710-4195	48	3
5305-00-263-8374	59	11	5305-00-716-8128	57	10
5305-00-269-2801	97	16	5305-00-716-8128	57	12
5305-00-269-2805	97	54	5305-00-721-4529	90	4

SECTION IV. NATIONAL STOCK NUMBER AND REFERENCE NUMBER INDEX (CONT.)

STOCK NUMBER	FIG. NO.	ITEM NO.	STOCK NUMBER	FIG. NO.	ITEM NO.
5305-00-724-5911	39	4	5305-00-984-6191	22	24
5305-00-724-5913	81	21	5305-00-984-6191	25	27
5305-00-732-0512	24	8	5305-00-984-6191	27	41
5310-00-732-0559	70	2	5305-00-984-6191	27	35
5305-00-753-4362	22	84	5305-00-984-6192	33	26
5305-00-753-4362	22	92	5305-00-984-6193	5	5
5305-00-758-8117	64	54	5305-00-984-6193	8	12
5305-00-762-6238	74	6	5305-00-984-6193	8	22
5305-00-782-7189	53	56	5305-00-984-6193	8	29
5305-00-782-9495	97	6	5305-00-984-6193	8	35
5305-00-786-4028	69	13	5305-00-984-6193	8	38
5305-00-786-4032	72	26	5305-00-984-6193	8	60
5305-00-783-3735	68	15	5305-00-984-6193	25	20
5305-00-808-9977	21	55	5305-00-984-6193	27	11
5305-00-824-1643	90	46	5305-00-984-6193	31	10
5305-00-846-0129	67	7	5305-00-984-6193	33	21
5305-00-889-2997	25	35	5305-00-984-6193	33	40
5305-00-889-2998	33	62	5305-00-984-6193	33	56
5305-00-889-2998	33	142	5305-00-984-6193	33	59
5305-00-889-3000	3	5	5305-00-984-6193	65	35
5305-00-889-3001	25	13	5305-00-984-6194	27	38
5305-00-889-3001	25	30	5305-00-984-6212	64	60
5305-00-889-3001	27	31	5305-00-984-6221	27	54
5305-00-889-3001	31	33	5305-00-987-1132	83	45
5305-00-889-3001	31	37	5305-00-989-7434	33	3
5305-00-889-3001	33	18	5305-00-989-7434	33	7
5305-00-889-3002	22	11	5305-00-989-7434	33	14
5305-00-891-8979	68	2	5305-00-989-7434	33	36
5305-00-891-8979	68	21	5305-00-989-7434	33	43
5305-00-900-8496	64	11	5305-00-989-7434	33	52
5305-00-915-8087	79	6	5305-00-989-7434	33	75
5305-00-927-0107	90	26	5305-00-993-8748	73	2
5305-00-934-0279	75	4	5305-01-007-1321	68	6
5305-00-941-9317	50	11	5305-01-010-2362	1	22
5305-00-954-1992	33	46	5305-01-014-2221	74	12
5305-00-958-6517	53	25	5305-01-014-4166	63	28
5305-00-969-4348	53	15	5305-01-014-4250	64	1
5305-00-978-9342	53	38	5305-01-014-4251	79	8
5305-00-978-9343	53	34	5305-01-014-4251	80	3
5305-00-978-9368	68	4	5305-01-014-4251	80	13
5305-00-978-9368	68	18	5305-01-014-4252	74	1
5305-00-983-7462	40	2	5305-01-017-1574	64	27
5305-00-983-4982	7	18	5305-01-018-0122	59	19
5305-00-984-4982	8	68	5305-01-038-3722	66	4
5305-00-984-4982	27	47	5305-01-072-9133	33	31
5305-00-984-4988	8	76	5305-01-078-5064	20	43
5305-00-984-4988	31	23	5305-01-078-5064	20	50
5305-00-984-4988	33	78	5306-00-033-7507	80	5
5305-00-984-4988	33	84	5306-00-056-4171	64	35
5305-00-984-4988	33	87	5306-00-207-3510	80	23
5305-00-984-4988	33	90	5306-00-225-8496	60	3

SECTION IV. NATIONAL STOCK NUMBER AND REFERENCE NUMBER INDEX (CONT.)

STOCK NUMBER	FIG. NO.	ITEM NO.	STOCK NUMBER	FIG. NO.	ITEM NO.
5306-00-225-8497	13	26	5307-00-839-1373	97	13
5306-00-225-8497	13	96	5307-00-916-6741	76	5
5306-00-225-8497	13	111	5307-00-927-2120	83	5
5306-00-225-8497	33	1	5307-01-025-7842	2	10
5306-00-225-8497	37	9	5307-01-108-0725	33	24
5306-00-225-8497	37	18	5310-00-010-3320	61	13
5306-00-225-8497	37	23	5310-00-010-3320	74	2
5306-00-225-8497	47	20	5310-00-010-3320	74	5
5306-00-225-8497	51	5	5310-00-010-3320	78	8
5306-00-225-8497	51	29	5310-00-010-3320	83	7
5306-00-225-8497	63	23	5310-00-019-0670	18	5
5306-00-225-8497	74	15	5310-00-019-0672	18	27
5306-00-225-8497	84	30	5310-00-020-4737	58	36
5306-00-225-8497	86	12	5310-00-033-7566	74	14
5306-00-225-8499	43	1	5310-00-038-2738	18	41
5306-00-225-8499	44	1	5310-00-038-2738	18	45
5306-00-225-8500	38	20	5310-00-038-2739	18	39
5306-00-225-8502	56	3	5310-00-043-0520	53	4
5306-00-225-9093	51	45	5310-00-045-3296	18	85
5306-00-226-4834	42	1	5310-00-045-3296	53	26
5306-00-364-2585	66	1	5310-00-045-3296	64	21
5306-00-463-0417	74	4	5310-00-045-3299	18	11
5306-00-550-9129	64	3	5313-00-045-3299	22	25
5306-00-550-9129	64	84	5310-00-045-3299	35	7
5306-00-616-5647	74	13	5310-00-045-3299	35	13
5306-00-616-5648	81	1	5310-00-045-4007	7	19
5306-00-616-5650	79	2	5310-00-045-4007	8	70
5306-00-618-0709	51	52	5310-00-045-4007	22	35
5306-00-618-0710	78	14	5310-00-045-4007	22	40
5306-00-618-0717	59	2	5310-00-045-4007	22	45
5306-00-775-5209	64	18	5310-00-045-4007	22	58
5306-00-786-4021	82	4	5310-00-045-4007	22	70
5306-00-819-3038	73	9	5310-00-045-4007	22	82
5305-00-843-8563	83	49	5310-00-045-4077	22	90
5306-00-882-7811	97	1	5310-00-045-4007	27	48
5306-00-916-6609	78	13	5310-00-045-4007	35	3
5306-00-958-8995	38	3	5310-00-045-4007	35	20
5306-00-008-6495	97	61	5310-00-045-4007	35	27
5306-01-117-9024	64	67	5310-00-052-3632	5	4
5307-00-261-0408	83	10	5310-00-052-3632	8	11
5307-00-033-5489	83	26	5310-00-052-3632	8	21
5307-00-429-0140	83	25	5310-00-052-3632	8	28
5307-00-466-7215	83	22	5310-00-052-3632	8	34
5307-00-605-8227	76	10	5310-00-052-3632	8	37
5307-00-616-6016	83	24	5310-00-052-3632	8	59
5307-00-616-7203	83	31	5310-00-052-3632	25	18
5307-00-616-7206	83	29	5310-00-052-3632	27	9
5307-00-616-7216	83	27	5310-00-052-3632	27	34
5307-00-623-1802	83	30	5310-00-052-3632	27	40
5307-00-630-4836	83	28	5310-00-052-3632	31	8
5307-00-677-8889	83	32	5310-00-052-3632	33	20

SECTION IV. NATIONAL STOCK NUMBER AND REFERENCE NUMBER INDEX (CONT.)

STOCK NUMBER	FIG. NO.	ITEM NO.	STOCK NUMBER	FIG. NO.	ITEM NO.
5310-00-052-3632	33	39	5310-00-081-4219	37	24
5310-00-052-3632	33	55	5310-00-081-4219	51	31
5310-00-052-3632	33	58	5310-00-081-4219	45	4
5310-00-052-3632	65	34	5310-00-081-4219	57	5
5310-00-056-3395	64	50	5310-00-081-4219	84	25
5310-00-058-5269	64	24	5310-00-081-4219	84	37
5310-00-059-9268	48	10	5310-00-081-4219	86	11
5310-00-061-1258	38	19	5310-00-081-4219	97	65
5310-00-061-1258	38	21	5310-00-082-1404	27	25
5310-00-061-1258	38	23	5310-00-082-1404	35	4
5310-00-061-1258	79	9	5310-00-082-1404	35	21
5310-00-062-1475	50	30	5310-00-082-1404	35	28
5310-00-062-1475	50	40	5310-00-082-1404	93	17
5310-00-062-2051	64	45	5310-00-082-1404	93	23
5310-00-063-7360	3	4	5310-00-094-3421	8	31
5310-00-063-7360	8	76	5310-00-094-3421	8	63
5310-00-063-7360	25	14	5310-00-094-3421	8	66
5310-00-063-7360	25	26	5310-00-094-3421	93	39
5310-00-063-7360	25	29	5310-00-094-3421	97	19
5310-00-063-7360	27	30	5310-00-132-1526	57	31
5310-00-063-7360	27	44	5310-00-145-2023	59	6
5310-00-063-7360	27	52	5310-00-166-8560	63	29
5310-00-063-7360	31	22	5310-00-167-0834	64	28
5310-00-063-7360	31	32	5310-00-167-9009	77	34
5310-00-063-7360	31	36	5310-00-168-6374	58	31
5310-00-063-7360	33	17	5310-00-178-9612	64	9
5310-00-063-7360	33	77	5310-00-184-8971	18	38
5310-00-063-7360	33	83	5310-00-193-9703	59	3
5310-00-063-7360	33	86	5310-00-194-0607	67	9
5310-00-063-7360	33	89	5310-00-194-0607	69	15
5310-00-063-7360	93	20	5310-00-194-1483	40	3
5310-00-063-7360	93	22	5310-00-199-1056	18	37
5310-00-063-7360	93	34	5310-00-209-0920	67	3
5310-00-063-7360	93	45	5310-00-209-0965	2	9
5310-00-063-7415	25	34	5310-00-209-3671	67	
5310-00-063-7415	33	61	5310-00-221-3153	18	46
5310-00-063-7415	33	141	5310-00-228-7563	18	8
5310-00-063-7415	89	16	5310-00-228-7578	18	67
5310-00-063-7415	93	47	5310-00-228-7579	18	63
5310-00-067-6357	21	42	5310-00-228-7591	18	53
5310-00-067-6357	27	5	5310-00-228-7591	18	55
5310-00-067-6357	33	30	5310-00-228-7599	18	71
5310-00-067-6357	50	3	5310-00-245-8670	58	2
5310-00-080-6004	1	23	5310-00-249-2279	80	24
5310-00-080-6004	13	102	5310-00-262-5142	77	24
5310-00-080-6004	13	107	5310-00-263-8416	18	66
5310-00-080-6004	37	7	5310-00-264-0694	18	86
5310-00-080-6004	51	4	5310-00-268-6093	61	12
5310-00-080-6004	51	26	5310-00-268-6093	78	7
5310-00-081-4219	37	11	5310-00-268-6093	83	6
5310-00-081-4219	37	19	5310-00-268-7271	64	48

SECTION IV. NATIONAL STOCK NUMBER AND REFERENCE INDEX (CONT.)

STOCK NUMBER	FIG. No.	ITEM No.	STOCK NUMBER	FIG. No.	ITEM No.
5310-00-269-5958	64	51	5310-00-550-1130	46	7
5310-00-269-6302	97	74	5310-00-559-0070	68	5
5310-00-275-9421	77	4	5310-00-582-5677	54	10
5310-00-276-2698	77	8	5310-00-582-5965	53	14
5310-00-281-9389	18	31	5310-00-582-5965	1	37
5310-00-288-2674	97	49	5310-00-582-5965	2	4
5310-00-297-2275	63	33	5310-00-582-5965	5	2
5310-00-303-0080	53	19	5310-00-582-5965	7	3
5310-00-373-0373	64	49	5310-00-582-5965	8	2
5310-00-393-0067	72	3	5310-00-582-5965	13	2
5310-00-297-4707	18	26	5310-00-582-5965	13	9
5310-00-297-4707	18	70	5310-00-582-5965	13	15
5310-00-397-4711	18	44	5310-00-582-5965	13	20
5310-00-397-4711	18	81	5310-00-582-5965	23	3
5310-00-397-5404	18	77	5310-00-582-5965	13	29
5310-00-397-5424	18	82	5310-00-582-5965	13	34
5310-00-400-3495		14	5310-00-582-5965	13	39
5310-00-407-9566	13	25	5310-00-582-5965	13	45
5310-00-407-9566	13	97	5310-00-582-5965	3	51
5310-00-407-9566	13	110	5310-00-582-5965	54	6
5310-00-407-9566	33	2	5310-00-582-5965	13	57
5310-00-407-9566	37	10	5310-00-582-5965	13	64
5310-00-407-9566	37	17	5310-00-582-5965	13	67
5310-00-407-9566	37	22	5310-00-582-5965	13	73
5310-00-407-9566	38	2	5310-00-582-5965	13	77
5310-00-407-9566	47	19	5310-00-582-5965	13	81
5310-00-407-9566	51	30	5310-00-582-5965	13	84
5310-00-407-9566	54	4	5310-00-582-5965	13	89
5310-00-407-9566	56	2	5310-00-582-5965	13	94
5310-00-407-9566	57	2	5310-00-582-5965	21	13
5310-00-407-9566	74	16	5310-00-582-5965	26	24
5310-00-410-8585	68	29	5310-00-582-5965	21	37
5310-00-420-6046	81	13	5310-00-582-5965	21	5
5310-00-432-3550	18	78	5310-00-582-5965	22	8
5310-00-436-1975	57	32	5310-00-582-5965	22	53
5310-00-461-8858	67	15	5310-00-582-5965	23	3
5310-00-464-2739	76	7	5310-00-582-5965	24	2
5310-00-476-7648	64	63	5310-00-582-5965	25	2
5310-00-482-8512	64	20	5310-00-582-5965	27	2
5310-00-486-2519	90	52	5310-00-582-5965	31	2
5310-00-505-2385	18	23	5310-00-582-5965	31	13
5310-00-505-2385	18	56	5310-00-582-5965	33	79
5310-00-543-2410	53	32	5310-00-582-5965	47	6
5310-00-543-2410	53	53	5310-00-582-5965	47	9
5310-00-543-2410	53	58	5310-00-582-5965	50	2
5310-00-543-5060	5	43	5310-00-582-5965	51	9
5310-00-550-1130	41	2	5310-00-582-5965	52	2
5310-00-550-1130	44	5	5310-00-582-5965	52	5
5310-00-550-1130	45	3	5310-00-582-5965	53	8
5310-00-550-1130	45	7	5310-00-582-5965	53	14
5310-00-550-1130	45	16	5310-00-582-5965	54	6

SECTION IV. NATIONAL STOCK NUMBER AND REFERENCE INDEX (CONT.)

STOCK NUMBER	FIG. No.	ITEM No.	STOCK NUMBER	FIG. No.	ITEM No.
5310-00-582-5965	56	9	5310-00-637-9541	1	18
5310-00-582-5965	56	17	5310-00-637-9541	13	100
5310-00-582-5965	84	9	5310-00-637-9541	12	102
5310-00-582-5965	84	16	5310-00-637-9541	22	2
5310-00-582-5965	84	33	5310-00-637-9541	37	6
5310-00-582-5965	85	3	5310-00-637-9541	48	2
5310-00-582-5965	86	10	5310-00-637-9541	48	22
5310-00-582-5965	92	18	5310-00-637-9541	49	2
5310-00-582-5965	93	22	5310-00-637-9541	49	15
5310-00-582-5965	93	44	5310-00-637-9541	51	2
5310-00-584-5272	24	99	5310-00-637-9541	51	22
5310-00-584-5272	37	2	5310-00-637-9541	51	24
5310-00-584-5272	50	14	5310-00-637-9541	64	26
5310-00-584-5272	50	20	5310-00-637-9541	75	5
5310-00-584-5272	50	25	5310-00-637-9541	75	17
5310-00-584-5272	50	29	5310-00-637-9541	76	2
5310-00-584-5272	50	35	5310-00-637-9541	78	3
5310-00-584-5272	50	39	5310-00-637-9541	78	12
5310-00-584-5272	51	6	5310-00-637-9541	80	4
5310-00-584-5272	53	65	5310-00-637-9541	80	16
5310-00-584-5272	54	3	5310-00-637-9541	83	2
5310-00-584-5272	57	9	5310-00-637-9541	83	39
5310-00-584-5272	57	13	5310-00-637-9541	97	15
5310-00-584-5272	79	7	5310-00-637-9541	97	68
5310-00-584-5272	80	7	5310-00-672-8890	82	2
5310-00-584-5272	84	29	5310-00-672-8890	21	41
5310-00-584-5272	88	37	5310-00-696-5173	33	23
5310-00-584-5272	97	4	5310-00-696-5173	33	25
5310-00-584-5272	97	11	5310-00-696-5173	98	20
5310-00-584-5272	98	5	5310-00-702-1797	64	23
5310-00-584-5272	98	29	5310-00-703-8213	77	25
5310-00-584-7890	68	5	5310-00-703-8214	77	9
5310-00-595-6475	59	12	5310-00-720-8395	18	22
5310-00-596-4694	22	85	5310-00-732-0538	13	99
5310-00-596-5096	79	5	5310-00-732-0558	1	17
5310-00-596-5096	80	6	5310-00-732-0558	13	104
5310-00-596-7691	93	16	5310-00-732-0558	22	1
5310-00-596-7693	22	12	5310-00-732-0558	37	5
5310-00-605-5259	76	6	5310-00-732-0558	51	1
5310-00-615-1829	51	50	5310-00-732-0558	51	23
5310-00-615-1830	59	10	5310-00-732-0558	83	1
5310-00-615-1835	63	21	5310-00-732-0558	67	2
5310-00-627-5028	63	22	5310-00-732-0559	76	1
5310-00-628-3834	63	24	5310-00-732-0559	97	53
5310-00-628-3860	77	3	5310-00-732-0560	97	10
5310-00-628-3874	80	19	5310-00-761-6822	4	1
5310-00-630-2383	21	9	5310-00-761-6822	47	4
5310-00-630-2801	48	4	5310-00-761-6822	50	1
5310-00-630-2801	49	5	5310-00-761-6822	56	8
5310-00-630-2802	64	2	5310-00-761-6822	56	16
5310-00-637-3027	78	15	5310-00-761-5822	84	8

SECTION IV. NATIONAL STOCK NUMBER AND REFERENCE NUMBER INDEX (CONT.)

STOCK NUMBER	FIG. NO.	ITEM NO.	STOCK NUMBER	FIG. NO.	ITEM NO.
5310-00-761-6882	85	30	5310-00-809-5997	97	5
5310-00-761-6882	87	35	5310-00-809-8544	8	23
5310-00-761-6882	92	17	5310-00-809-8544	21	27
5310-00-761-6882	1	35	5310-00-809-8544	21	31
5310-00-761-6882	13	1	5310-00-809-8544	25	19
5310-00-761-6882	13	8	5310-00-809-8544	27	10
5310-00-761-6882	13	14	5310-00-809-8544	27	37
5310-00-761-6882	13	19	5310-00-809-8544	31	9
5310-00-761-6882	13	38	5310-00-809-8546	8	67
5310-00-761-6882	13	44	5310-00-809-8553	38	4
5310-00-761-6882	13	50	5310-00-820-6653	63	20
5310-00-761-6882	13	56	5310-00-820-6653	81	22
5310-00-761-6882	13	75	5310-00-822-2236	64	44
5310-00-761-6882	13	79	5310-00-822-2241	64	39
5310-00-761-6882	13	85	5310-00-823-8804	1	38
5310-00-761-6882	13	91	5310-00-823-8804	13	60
5310-00-761-6882	21	23	5310-00-823-8804	25	3
5310-00-761-6882	21	36	5310-00-823-8804	27	4
5310-00-761-6882	23	52	5310-00-823-8804	31	3
5310-00-761-6882	24	1	5310-00-823-8804	31	12
5310-00-761-6882	41	1	5310-00-823-8804	33	6
5310-00-761-6882	47	8	5310-00-823-8804	47	11
5310-00-763-8921	38	1	5310-00-823-8804	50	5
5310-00-765-3197	35	8	5310-00-823-8804	85	33
5310-00-768-0318	50	13	5310-00-824-2688	58	44
5310-00-768-0318	50	19	5310-00-830-7825	67	16
5310-00-768-0318	50	24	5310-00-851-2242	33	45
5310-00-768-0318	50	28	5310-00-853-9336	97	14
5310-00-768-0318	50	34	5310-00-854-4342	51	61
5310-00-768-0318	50	38	5310-00-877-4952	70	17
5310-00-768-0318	57	8	5310-00-877-4956	68	11
5310-00-768-0318	97	3	5310-00-877-4956	68	24
5310-00-787-6466	71	9	5310-00-877-4957	70	14
5310-00-791-9437	70	1	5310-00-880-7744	13	24
5310-00-796-8638	67	8	5310-00-880-7744	13	95
5310-00-796-8638	68	7	5310-00-880-7744	13	109
5310-00-796-8638	69	14	5310-00-880-7744	37	16
5310-00-807-1466	67	13	5310-00-880-7744	37	21
5310-00-807-1469	84	24	5310-00-880-7744	47	18
5310-00-809-3078	22	54	5310-00-880-7744	48	16
5310-00-809-4058	54	7	5310-00-880-7744	56	1
5310-00-809-4058	98	15	5310-00-880-7744	84	28
5310-00-809-5997	37	3	5310-00-880-7744	84	38
5310-00-809-5997	50	16	5310-00-880-7744	86	9
5310-00-809-5997	50	22	5310-00-880-8186	50	10
5310-00-809-5997	50	27	5310-00-880-8189	2	8
5310-00-809-5997	50	32	5310-00-881-1763	97	40
5310-00-809-5997	50	37	5310-00-883-9384	93	24
5310-00-809-5997	50	42	5310-00-889-2527	42	2
5310-00-809-5997	57	11	5310-00-889-2527	43	2
5310-00-809-5997	85	28	5310-00-889-2527	44	2

SECTION IV. NATIONAL STOCK NUMBER AND REFERENCE NUMBER INDEX (CONT.)

STOCK NUMBER	FIG. NO.	ITEM NO.	STOCK NUMBER	FIG. NO.	ITEM NO.
5310-00-889-2528	38	6	5310-00-934-9751	68	22
5310-00-889-2528	38	9	5310-00-934-9751	69	12
5310-00-889-2528	38	12	5310-00-934-9751	88	26
5310-00-889-2528	38	16	5310-00-934-9751	88	29
5310-00-889-2528	46	3	5310-00-934-9751	89	1
5310-00-889-2528	46	16	5310-00-934-9751	92	22
5310-00-891-8931	67	23	5310-00-934-9751	93	15
5310-00-897-6082	20	8	5310-00-934-9757	35	6
5310-00-902-1121	64	66	5310-00-934-9757	67	14
5310-00-902-1124	64	52	5310-00-934-9757	98	7
5310-00-911-5467	97	21	5310-00-934-9758	64	62
5310-00-911-5468	97	22	5310-00-939-1061	18	7
5310-00-913-3366	84	36	5310-00-953-5600	65	3
5310-00-917-0963	78	30	5310-00-982-4933	53	33
5310-00-924-1807	54	11	5310-00-983-8483	22	36
5310-00-928-2683	18	76	5310-00-983-8483	22	41
5310-00-929-1807	53	1	5310-00-983-8483	22	46
5310-00-933-8118	53	35	5310-00-983-8483	22	59
5310-00-933-8118	53	39	5310-00-983-8483	22	71
5310-00-934-9739			5310-00-983-8483	22	83
5310-00-935-9739	25	23	5310-00-983-8483	22	91
5310-00-934-9739	27	12	5310-00-983-8483	27	53
5310-00-934-9739	27	14	5310-00-984-3806	57	4
5310-00-934-9739	98	23	5310-00-987-6365	77	5
5310-00-934-9739	99	5	5310-00-991-2949	35	9
5310-00-934-9747	1	25	5310-00-994-1601	59	6
5310-00-934-9747	3	10	5310-00-997-1888	23	4
5310-00-934-9747	22	34	5310-00-997-1888	5	5
5310-00-934-9747	22	39	5310-01-004-9535	53	22
5310-00-934-9747	22	44	5310-01-007-8524	97	59
5310-00-934-9747	22	57	5310-01-007-8642	97	60
5310-00-934-9747	22	69	5310-01-008-6597	19	68
5310-00-934-9747	22	81	5310-01-012-3595	33	5
5310-00-934-9747	22	89	5310-01-012-3595	33	13
5310-00-934-9747	25	21	5310-01-012-3595	33	25
5310-00-934-9747	27	17	5310-01-012-3595	33	35
5310-00-934-9747	27	24	5310-01-012-3595	33	42
5310-00-934-9747	31	15	5310-01-012-3595	33	44
5310-00-934-9747	31	19	5310-01-012-3595	33	51
5310-00-934-9747	35	2	5310-01-013-5787	64	22
5310-00-934-9747	35	19	5310-01-014-1219	63	28
5310-00-934-9747	35	26	5310-01-014-2500	21	9
5310-00-934-9747	53	29	5310-01-014-6163	77	21
5310-00-934-9747	99	3	5310-01-014-8279	63	26
5310-00-934-9747	99	31	5310-01-017-2501	48	11
5310-00-934-9751	13	70	5310-01-017-3876	21	18
5310-00-934-9751	21	19	5310-01-018-1314	57	18
5310-00-934-9751	21	19	5310-01-033-4893	18	12
5310-00-934-9751	21	41	5310-01-034-2835	21	6
5310-00-934-9751	64	25	5310-01-039-3340	66	5
5310-00-934-9751	68	3	5310-01-040-7974	80	15

SECTION IV. NATIONAL STOCK NUMBER AND REFERENCE INDEX (CONT.)

STOCK NUMBER	FIG. No.	ITEM No.	STOCK NUMBER	FIG. No.	ITEM No.
5310-01-055-4400	64	36	5330-00-001-6680	57	27
5310-01-054-8415	77	22	5330-00-036-6995	13	6
5310-01-119-4047	66	2	5330-00-036-6995	13	18
5315-01-012-4553	81	20	5330-00-036-6995	13	23
5315-01-017-9252	61	4	5330-00-036-6995	13	36
5315-01-021-8211	81	25	5330-00-036-6995	13	48
5315-01-021-8211	82	3	5330-00-036-6996	13	13
5315-00-063-9016	2	6	5330-00-036-6996	18	42
5315-00-133-3625	57	37	5330-00-036-6996	18	14
5315-00-133-3625	58	13	5330-00-036-6998	18	25
5315-00-193-4113	97	72	5330-00-060-1679	22	26
5315-00-218-6316	97	64	5330-00-061-8358	64	30
5315-00-291-5471	53	41	5330-00-061-8538	71	12
5315-00-297-2444	97	47	5330-00-067-3358	51	12
5315-00-298-1481	50	9	5330-00-079-7839	22	27
5315-00-298-9739	2	6	5330-00-119-4732	90	19
5315-00-359-0752	97	66	5330-00-133-0811	77	41
5315-00-373-0080	97	48	5330-00-145-5030	90	50
5315-00-393-5887	83	23	5330-00-150-1653	59	26
5315-00-400-3619	83	33	5330-00-167-9009	66	14
5315-00-400-5575	78	25	5330-00-171-5641	69	3
5315-00-449-2945	8	3	5330-00-171-6649	56	15
5315-00-543-3714	97	77	5330-00-171-7034	76	9
5315-00-786-3998	70	4	5330-00-187-3635	49	13
5315-00-806-9711	97	30	5330-00-211-9920	53	28
5315-00-839-2326	51	34	5330-00-213-8901	62	60
5315-00-842-3044	59	5	5330-00-228-7468	18	13
5315-00-842-3044	97	71	5330-00-231-0283	80	14
5315-00-842-9743	53	17	5330-00-240-0834	3	7
5315-00-844-3662	81	16	5330-00-250-5753	64	79
5315-00-887-1539	72	14	5330-00-251-4082	51	55
5315-00-992-7084	69	18	5330-00-251-4082	51	48
5315-00-025-4737	97	42	5330-00-260-9311	64	41
5315-00-025-4754	97	33	5330-00-291-8972	76	4
5320-00-206-1400	8	72	5330-00-316-7248	53	22
5320-00-241-6020	8	84	5330-00-357-2064	53	20
5320-00-303-1060	87		5330-00-379-4626	22	29
5320-00-510-7823	87		5330-00-401-5247	83	
5320-00-938-6713	87		5330-00-461-5732	90	
5325-00-027-0322	37		5330-00-462-4524	90	44
5325-00-099-8827	8	5	5330-00-491-9391	56	14
5325-00-174-9038	98	26	5330-00-506-3975	73	8
5325-00-177-4162	31	25	5330-00-530-2523	80	12
5325-00-185-0012	93	29	5330-00-530-2523	83	40
5325-00-291-9166	33	15	5330-00-536-6908	22	16
5325-00-432-9902	8	4	5330-00-582-2855	48	20
5325-00-449-2967	8	85	5330-00-584-1040	53	10
5325-00-343-5531	13	55	5330-00-584-1040	53	48
5325-00-582-3601	37	13	5330-00-598-8962	80	10
5325-00-889-1271	90	36	5330-00-599-2321	64	10
5325-00-926-0665	18	49	5330-00-615-1834	84	18

SECTION IV. NATIONAL STOCK NUMBER AND REFERENCE INDEX (CONT.)

STOCK NUMBER	FIG. No.	ITEM No.	STOCK NUMBER	FIG. No.	ITEM No.
5330-00-615-1838	83	42	5330-01-100-2073	58	18
5330-00-631-6649	97	25	5330-01-101-4858	56	6
5330-00-640-9399	67	12	5330-01-102-0619	41	7
5330-00-641-8282	68	10	5330-01-113-9678	84	61
5330-00-641-8282	68	23	5330-01-268-2615	84	21
5330-00-641-8283	69	6	5330-01-385-4381	2	12
5330-00-641-8283	71	18	5330-01-391-9654	48	9
5330-00-641-8286	70	2	5335-00-211-0783	87	1
5330-00-641-8291	72	11	5340-00-014-5623	90	27
5330-00-649-8437	78	6	5340-00-050-2740	8	36
5330-00-649-8445	74	18	5340-00-050-2740	98	11
5330-00-663-4773	49	9	5340-00-053-8994	85	4
5330-00-678-3815	74	22	5340-00-057-2904	8	33
5330-00-678-3817	74	10	5340-00-057-2904	90	28
5330-00-678-3823	77	7	5340-00-057-2904	92	24
5330-00-763-9322	50	7	5340-00-057-2904	98	9
5330-00-776-0580	51	58	5340-00-057-3037	86	
5330-00-786-4025	67	17	5340-00-067-3868	92	29
5330-00-790-2659	80	9	5340-00-079-7837	98	10
5330-00-804-5695	55	16	5340-00-088-1254	31	14
5330-00-805-2966	55	22	5340-00-095-6789	53	6
5330-00-833-7491	55	23	5340-00-118-3015	51	60
5330-00-836-4356	22	20	5340-00-125-6003	68	19
5330-00-842-0362	77	2	5340-00-143-4775	27	68
5330-00-842-0363	61	15	5340-00-229-3643	13	12
5330-00-842-0363	83	9	5340-00-324-2519	83	11
5330-00-853-2376	69	19	5340-00-400-0076	48	24
5330-00-877-4960	69	11	5340-00-400-0076	49	17
5330-00-877-4960	70	12	5340-00-486-1765	86	13
5330-00-877-4972	73	13	5340-00-616-5652	45	17
5330-00-893-7799	79	12	5340-00-616-5652	48	17
5330-00-893-7999	80	30	5340-00-616-6170	40	1
5330-00-905-4392	73	4	5340-00-623-1725	77	10
5330-00-914-0703	64	83	5340-00-626-9402	2	13
5330-00-932-1865	59	13	5340-00-630-4813	85	14
5330-00-936-4587	71	15	5340-00-677-5785	33	57
5330-00-936-5043	64	59	5340-00-677-5786	33	60
5330-00-937-8477	70	15	5340-00-705-7807	75	8
5330-00-966-9138	59	15	5340-00-725-5279	55	10
5330-00-971-5807	75	10	5340-00-725-6033	31	28
5330-00-971-5607	75	19	5340-00-764-7051	30	6
5330-00-972-8836	59	4	5340-00-785-1550	68	13
5330-00-974 6643	71	3	5340-00-786-4027	72	24
5330-00-997-9020	64	38	5340-00-809-1492	85	21
5330-01-012-3062	24	11	5340-00-809-1492	87	5
5330-01-014-6985	71	2	5340-00-809-8805	18	57
5330-01-017-5616	41	6	5340-00-823-5322	4	9
5330-01-022-7995	83		5340-00-823-5322	28	5
5330-01-022-7996	83		5340-00-823-5322	30	4
5330-01-028-7654	79	11			
5330-01-055-4548	78	5			

SECTION IV. NATIONAL STOCK NUMBER AND REFERENCE NUMBER INDEX (CONT.)

STOCK NUMBER	FIG. NO.	ITEM NO.	STOCK NUMBER	FIG. NO.	ITEM NO.
5340-00-823-5322	36	4	5365-00-263-3831	51	38
5340-00-823-5322	105		5365-00-282-7145	72	4
5340-00-843-7825	93	31	5365-00-408-6019	97	69
5340-00-922-6300	88	31	5365-00-441-0249	71	6
5340-00-984-8540	86	5	5365-00-485-0097	70	19
5340-00-984-8540	98	2	5365-00-536-6677	53	55
5340-00-988-1162	21	28	5365-00-556-7446	69	10
5340-00-988-1162	21	35	5365-00-630-2441	39	5
5340-01-024-9937	2	7	5365-00-715-1152	64	37
5340-01-025-6547	78	26	5365-00-720-6341	13	54
5340-01-053-7130	8	82	5365-00-753-9528	64	82
5340-01-194-2945	13	4	5365-00-786-3964	72	25
5340-01-197-1748	13	5	5365-00-804-9666	64	46
5340-01-198-7898	13	11	5365-00-833-7454	53	18
5355-00-538-7331	8	86	5365-00-929-1745	78	31
5355-00-916-2060	8	39	5365-00-961-1158	82	5
5355-00-916-2060	8	49	5365-01-012-3600	58	15
5360-00-135-1105	59	17	5365-01-015-6800	81	18
5360-00-221-6558	90	40	5365-01-017-0573	61	7
5360-00-231-1501	18	74	5365-01-017-3981	61	6
5360-00-267-0777	53	37	5365-01-024-9931	48	8
5360-00-335-9327	68	32	5875-00-111-3208	27	80
5360-00-343-3396	51	51	5905-00-001-3050	22	18
5360-00-418-4365	69	7	5905-00-081-3919	22	66
5360-00-449-5861	71	4	5905-00-105-7764	33	116
5360-00-485-0715	90	53	5905-00-105-7767	33	94
5360-00-543-3760	77	14	5905-00-106-1245	33	131
5360-00-691-7207	67	20	5905-00-106-9346	33	129
5360-00-696-8522	51	35	5905-00-107-0656	33	120
5360-00-733-9916	64	15	5905-00-110-0196	7	29
5360-00-751-8916	68	14	5905-00-111-4858	33	109
5360-00-784-0330	72	28	5905-00-113-4861	33	121
5360-00-786-1546	70	6	5905-00-118-4559	33	99
5360-00-812-0196	64	40	5905-00-121-9861	33	128
5360-00-812-8893	51	44	5905-00-135-4336	31	6
5365-00-859-5922	90	11	5905-00-140-9086	31	24
5360-00-859-5923	90	10	5905-00-141-0717	33	95
5360-00-884-8209	72	13	5905-00-141-0743	33	97
5360-00-887-1536	73	12	5905-00-141-1168	7	27
5360-00-900-2564	69	21	5905-00-141-1183	33	117
5360-01-022-3146	70	10	5905-00-141-1183	33	135
5360-01-025-4653	78	27	5905-00-141-1183	33	136
5365-00-122-2795	90	24	5905-00-165-3280	22	17
5365-00-133-0909	58	8	5905-00-173-1119	33	124
5365-00-137-5116	18	35	5905-00-172-4646	33	130
5365-00-140-9308	18	34	5905-00-250-5986	33	110
5365-00-141-6493	105	3	5905-00-252-1671	33	105
5365-00-191-3978	77	11	5905-00-264-7368	8	40
5365-00-209-3148	67	21	5905-00-333-8368	22	75
5365-00-216-1229	5	25	5905-00-357-2810	22	19
5365-00-252-4746	51	59	5905-00-359-4131	22	49

SECTION IV. NATIONAL STOCK NUMBER AND REFERENCE NUMBER INDEX (CONT.)

STOCK NUMBER	FIG. NO.	ITEM NO.	STOCK NUMBER	FIG. NO.	ITEM NO.
5905-00-359-4132	22	51	5910-00-254-8164	33	137
5905-00-371-6625	22	21	5910-00-331-9981	22	101
5905-00-371-6626	22	20	5910-00-331-9989	22	
5905-00-357-3093	27	58	5910-00-331-9990	22	
5905-00-378-0250	22	15	5910-00-331-9999	22	103
5905-00-378-0840	22	95	5910-00-431-8036	22	65
5905-00-378-0840	22	95	5910-00-434-1602	22	100
5905-00-429-7153	22	67	5910-00-577-1348	21	44
5905-00-429-7153	22	75	5910-00-577-1348	33	33
5905-00-429-7153	22	80	5910-00-577-1349	21	45
5905-00-432-0402	33	103	5910-00-577-1349	33	32
5905-00-432-0421	33	100	5910-00-603-9041	33	38
5905-00-432-9153	33	102	5910-00-603-9050	33	38
5905-00-448-5539	27	59	5910-00-879-3478	8	65
5905-00-459-2558	25	36	5910-01-063-6334	33	114
5905-00-481-8904	33	133	5910-01-100-8802	31	27
5905-00-636-7778	33	49	5920-01-280-3478	57	17
5905-00-642-1955	27	28	5920-00-280-4465	7	11
5905-00-642-2162	22	87	5920-00-450-8921	58	38
5905-00-642-2162	22	96	5920-00-450-8921	57	18
5905-00-642-5025	35	11	5920-00-474-6125	93	9
5905-00-665-7855	8	50	5920-00-875-4100	7	12
5905-00-770-5290	33	130	5920-00-875-4100	93	8
5905-00-785-6082	33	115	5925-00-682-4015	93	7
5905-00-805-8471	27	29	5925-00-686-3298	7	1
5905-00-846-8140	33	54	5925-00-686-3301	3	13
5905-00-853-0154	33	50	5925-00-686-3301	89	6
5905-00-860-6276	27	27	5930-00-044-3518	8	56
5905-00-860-6276	33	53	5930-00-214-0431	8	20
5905-00-879-1163	27	60	5930-00-329-6497	92	31
5905-00-952-1620		124	5930-00-375-0139	99	30
5905-00-973-9226	8	73	5930-00-430-3532	24	6
5905-01-021-9133	27	8	5930-00-532-0777	90	8
5905-01-060-3862	33	134	5930-00-601-6342	93	6
5905-01-107-2188	33	92	5930-00-615-4177	88	13
5910-00-007-2004	33	132	5930-00-615-6731	8	46
5910-00-007-5626	22	102	5930-00-615-7880	7	13
5910-00-007-5627	22	77	5930-00-621-7133	63	2
5910-00-009-9998	7	23	5930-00-655-1514	8	53
5910-00-060-9391	22	50	5930-00-655-1514	99	10
5910-00-083-5049	22		5930-00-655-1522	8	58
5910-00-113-5286	33	104	5930-00-655-1575	89	5
5910-00-113-5445	33	106	5930-00-655-1581	8	45
5910-00-113-5475	33	122	5930-00-655-1581	8	53
5910-00-127-3082	33	114	5930-00-655-1582	8	52
5910-00-166-9158	22		5930-00-708-3588	90	15
5910-00-166-9158	22		5930-00-782-8590	8	57
5910-00-226-8109	22	79	5930-00-854-8344	90	7
5910-00-233-1780	7	15	5930-00-914-6450	19	69
5910-00-236-8767	33	96	5930-00-945-1592	31	7
5910-00-254-2790	33	118	5930-00-993-4654	18	64

SECTION IV. NATIONAL STOCK NUMBER AND REFERENCE NUMBER INDEX (CONT.)

STOCK NUMBER	FIG. NO.	ITEM NO.	STOCK NUMBER	FIG. NO.	ITEM NO.
5930-01-009-0953	75	15	5935-00-723-5281	15	1
5930-01-018-1888	61		5935-00-723-5281	30	1
5930-01-018-6787	61	2	5935-00-725-0888	25	39
5930-01-021-9378	62		5935-00-725-0888	107	1
5930-01-023-4343	61		5935-00-725-4153	91	2
5930-01-043-6966	88	13	5935-00-725-4153	96	2
5935-00-007-2179	7		5935-00-725-7248	26	1
5935-00-016-2473	8	72	5935-00-725-8233	10	3
5935-00-024-1038	18	58	5935-00-725-8233	16	1
5935-00-024-1050	18	59	5935-00-725-8233	36	1
5935-00-089-4487	15	6	5935-00-726-8317	27	77
5935-00-089-4487	95	5	5935-00-727-7560	4	4
5935-00-106-3713	90	3	5935-00-752-2793	26	2
5935-00-137-4670	27	22	5935-00-755-2787	25	38
5935-00-137-4879	98	13	5935-00-755-2892	94	1
5935-00-167-7775	15	12	5935-00-755-3144	11	1
5935-00-172-8039	101	4	5935-00-755-3494	27	73
5935-00-189-8932	15	4	5935-00-800-2824	22	105
5935-00-206-1400	27	50	5935-00-800-2824	53	54
5935-00-210-8648	7	25	5935-00-801-6617	4	5
5935-00-211-0783	101	3	5935-00-801-6617	103	1
5935-00-232-7208	99	7	5935-00-801-6620	27	70
5935-00-275-6408	1	39	5935-00-801-6621	27	72
5935-00-280-2353	105	2	5935-00-806-3564	105	1
5935-00-295-6403	1	44	5935-00-806-4587	104	1
5935-00-367-7625	35	15	5935-00-806-4588	94	2
5935-00-368-2353	106	1	5935-00-811-8064	28	2
5935-00-432-8607	27	76	5935-00-813-4364	33	144
5935-00-432-8967	15	6	5935-00-813-4717	15	3
5935-00-432-8967	16	11	5935-00-813-4722	22	106
5935-00-432-8967	32	2	5935-00-814-9781	34	1
5935-00-500-5008	27	23	5935-00-814-9781	32	1
5935-00-500-5008	99	8	5935-00-819-5886	17	1
5935-00-548-1529	16	4	5935-00-820-0555	17	2
5935-00-553-3094	15	5	5935-00-821-0345	33	65
5935-00-557-2054	53	59	5935-00-823-5322	4	10
5935-00-565-9497	106		5935-00-823-5322	10	2
5935-00-565-9503	15	19	5935-00-823-5322	11	5
5935-00-565-9503	95	2	5935-00-823-5322	15	18
5935-00-601-6372	6	1	5935-00-823-5322	16	14
5935-00-608-1876	15	21	5935-00-823-5322	17	5
5935-00-682-0567	27	74	5935-00-823-5322	26	3
5935-00-702-4199	22	23	5935-00-823-5322	29	4
5935-00-721-0488	16	10	5935-00-823-5322	32	6
5935-00-721-0488	29	2	5935-00-823-5322	33	72
5935-00-721-0496	22	107	5935-00-823-5322	34	2
5935-00-721-0496	33	66	5935-00-824-7883	27	79
5935-00-721-0501	27	75	5935-00-827-9045	22	108
5935-00-721-0501	31	47	5935-00-834-4904	33	64
5935-00-721-0708	31	46	5935-00-834-6220	104	5
5935-00-721-1081	29	1	5935-00-839-9681	100	1

SECTION IV. NATIONAL STOCK NUMBER AND REFERENCE NUMBER INDEX (CONT.)

STOCK NUMBER	FIG. NO.	ITEM NO.	STOCK NUMBER	FIG. NO.	ITEM NO.
5935-00-842-6316	27	71	5940-00-143-4775	89	12
5935-00-842-6316	89	19	5940-00-143-4775	94	5
5935-00-844-4467	9	12	5940-00-143-4775	102	1
5935-00-844-4467	27	78	5940-00-143-4777	27	67
5935-00-845-1349	28	1	5940-00-143-4777	45	19
5935-00-845-1349	32	3	5940-00-143-4777	46	20
5935-00-845-1349	27	21	5940-00-143-4780	9	9
5935-00-845-1701	15	2	5940-00-143-4780	10	9
5935-00-846-2329	11	2	5940-00-143-4780	15	9
5935-00-846-5602	30	2	5940-00-143-4780	25	42
5935-00-851-9080	10	1	5940-00-143-4780	27	69
5935-00-852-9611	89	18	5940-00-143-4780	34	5
5935-00-879-0235	95	1	5940-00-143-4780	106	4
5935-00-879-3265	91	1	5940-00-143-4780	107	2
5935-00-879-3265	96	1	5940-00-143-4793	10	7
5935-00-938-7841	47	13	5940-00-143-4793	15	15
5935-01-009-3097	3		5940-00-143-4793	34	7
5935-01-012-3080	3	12	5940-00-143-4793	27	64
5940-00-003-8579	21	10	5940-00-143-4794	15	13
5940-00-061-6298	64	34	5940-00-143-4794	102	3
5940-00-088-6357	8	69	5940-00-159-0237	33	126
5940-00-107-1481	105	6	5940-00-204-8966	9	4
5940-00-113-8183	10	8	5940-00-204-8966	25	32
5940-00-113-8184	9	7	5940-00-204-8966	25	41
5940-00-113-8184	33	68	5940-00-204-8966	27	65
5940-00-113-9826	15	14	5940-00-204-8966	31	48
5940-00-114-1310	104	6	5940-00-204-8966	33	10
5940-00-114-1310	106	3	5940-00-204-8966	33	67
5940-00-115-0776	1	8	5940-00-204-8966	33	148
5940-00-115-0776	1	15	5940-00-204-8990	89	10
5940-00-115-0776	1	32	5940-00-230-0515	2	10
5940-00-115-0776	1	42	5940-00-230-0515	34	6
5940-00-115-2677	8	26	5940-00-234-3383	84	39
5940-00-115-2677	87	11	5940-00-237-2703	20	20
5940-00-115-2678	14	2	5940-00-283-5280	9	8
5940-00-115-4996	18	92	5940-00-283-5280	15	23
5940-00-115-4996	84	41	5940-00-283-5280	27	63
5940-00-115-5023	84	42	5940-00-283-5280	31	30
5940-00-143-4474	10	5	5940-00-283-5280	89	9
5940-00-143-4771	9	6	5940-00-283-5280	94	3
5940-00-143-4774	3	9	5940-00-283-5280	99	12
5940-00-143-4774	4	6	5940-00-283-5280	99	15
5940-00-143-4774	9	11	5940-00-283-5280	99	18
5940-00-143-4774	12	1	5940-00-283-5280	99	21
5940-00-143-4774	15	10	5940-00-283-5280	99	24
5940-00-143-4774	34	4	5940-00-283-5280	99	27
5940-00-143-4774	89	11	5940-00-283-5280	103	5
5940-00-143-4774	94	4	5940-00-283-5280	104	3
5940-00-143-4774	95	6	5940-00-420-5240	90	5
5940-00-143-4774	104	7	5940-00-549-6581	1	4
5940-00-143-4775	15	11	5940-00-549-6581	1	10

TM9-6115-465-24P
 TO 35C2-3-446-4
 NAVFACP-8-625-24P
 SL-4-06858B/06859D

SECTION IV. NATIONAL STOCK NUMBER AND REFERENCE NUMBER INDEX (CONT.)

STOCK NUMBER	FIG. NO.	ITEM NO.	STOCK NUMBER	FIG. NO.	ITEM NO.
5940-00-549-6583	1	2	5945-00-686-6877	27	42
5940-00-549-6583	1	13	5945-00-919-7749	25	9
5940-00-552-4338	19	1	5945-00-922-0030	31	18
5940-00-557-1629	9	5	5945-00-922-0031	31	41
5940-00-557-1629	25	42	5945-01-010-5913	19	37
5940-00-557-1629	27	66	5945-01-010-5914	19	45
5940-00-557-1629	31	49	5945-01-010-5917	19	60
5940-00-557-1629	33	69	5945-01-021-4122	18	16
5940-00-557-4338	18	93	5950-00-024-1000	21	32
5940-00-557-4338	20	1	5950-00-024-1052	18	87
5940-00-557-3807	31	29	5950-00-116-3471	22	48
5940-00-578-3482	27	33	5950-00-116-3472	22	48
5940-00-606-4967	1	33	5950-00-116-3613	22	38
5940-00-606-4969			5950-00-116-3614	22	63
5940-00-606-4969	1	13	5950-00-116-3616	22	63
5940-00-606-4970	21	7	5950-00-116-3546	22	62
5940-00-606-4972	21	11	5950-00-116-3664	22	68
5940-00-614-9461	64	57	5950-00-148-6066	22	38
5940-00-632-7234	25	17	5950-00-148-6067	22	43
5940-00-660-3633	12	2	5950-00-148-6069	22	43
5940-00-683-4339	18	72	5950-00-211-2000	53	44
5940-00-767-1596	7	31	5950-00-327-9625	35	30
5940-00-768-8794	18	9	5950-00-333-0759	93	41
5940-00-813-0698	22	109	5950-00-431-7828	33	93
5940-00-817-5556	15	20	5950-00-600-0840	33	29
5940-00-825-5041	27	62	5950-00-600-0842	33	29
5940-00-891-5990	64	31	5950-00-600-0843	33	41
5940-00-950-7781	1	27	5950-00-600-0844	21	40
5940-00-983-6045	25	31	5950-00-600-0845	99	33
5940-00-983-6047	31	34	5950-00-601-6296	27	36
5940-00-983-6049	31	38	5950-00-603-6286	33	22
5940-00-983-6049	33	19	5950-00-603-6989	21	29
5940-00-983-6051	25	16	5950-00-603-6990	21	29
5940-00-983-6093	27	55	5950-00-042-8637	27	51
5940-00-983-6096	27	32	5950-01-010-0007	21	40
5940-00-983-6105	8	61	5961-00-079-5958	7	28
5945-00-007-1147	21	43	5961-00-081-6392	33	98
5945-00-007-1147	21	49	5961-00-135-6168	8	74
5945-00-057-5655	25	12	5961-00-135-6168	27	57
5945-00-318-3050	25	7	5961-00-226-8697	33	81
5945-00-371-9858	18	75	5961-00-394-0902	47	23
5945-00-371-9958	18	15	5961-00-490-0318	33	111
5945-00-394-6857	18	51	5961-00-702-5763	27	56
5945-00-394-6865	18	87	5961-00-724-5970	33	11
5945-00-420-4561	25	10	5961-00-724-5970	93	18
5945-00-430-3576	31	41	5961-00-811-8372	7	30
5945-00-435-1833	7	20	5961-00-826-9048	33	123
5945-00-435-1833	8	71	5961-00-892-0888	45	4
5945-00-435-1833	27	49	5961-00-892-0888	46	4
5945-00-450-9136	31	43	5961-00-892-0919	33	113
5945-00-557-4345	20	4	5961-00-914-9740	33	127

SECTION IV. NATIONAL STOCK NUMBER AND REFERENCE NUMBER INDEX (CONT.)

STOCK NUMBER	FIG. NO.	ITEM NO.	STOCK NUMBER	FIG. NO.	ITEM NO.
5961-00-901-2290	45	5	5970-00-915-6133	7	
5961-00-901-2290	46	5	5970-00-954-1622	4	8
5961-00-929-5014	22	56	5970-00-954-1622	7	24
5961-00-949-1440	33	107	5970-00-954-1622	8	41
5961-00-950-6577	33	101	5970-00-954-1622	9	13
5961-00-951-8757	33	112	5970-00-954-1622	25	40
5961-00-958-5391	33	119	5970-00-954-1622	27	81
5961-00-998-6947	22	64	5970-00-954-1622	31	51
5961-00-998-6947	22	74	5970-00-954-1622	33	
5961-00-998-6947	22	88	5970-00-954-1622	33	27
5961-00-998-6947	35	25	5970-00-954-1622	33	73
5961-00-998-9317	33	12	5970-00-954-1622	33	147
5961-00-998-9317	93	19	5970-00-954-1622	35	16
5961-00-020-2904	57	29	5970-00-954-1622	7	
5961-00-020-4439	57	30	5975-00-074-2072	9	3
5962-00-197-3361	33	108	5975-00-074-2072	15	16
5965-00-598-5416	16	7	5975-00-074-2072	22	112
5970-00-030-7629	18	48	5975-00-074-2072	94	8
5970-00-097-9798	5	8	5975-00-111-3208	1	29
5970-00-148-6300	58	14	5975-00-111-3208	4	9
5970-00-311-5943	93	36	5975-00-111-3208	7	
5970-00-376-1307	22	86	5975-00-111-3208	11	4
5970-00-378-9939	22	94	5975-00-111-3208	12	3
5970-00-408-0410			5975-00-111-3208	15	17
5970-00-408-0410	22	111	5975-00-111-3208	17	4
5970-00-548-1098	27	82	5975-00-111-3208	18	94
5970-00-543-1154	45	18	5975-04-111-3208	20	2
5970-00-543-1154	46	19	5975-00-111-3208	25	43
5970-00-815-1295	8	42	5975-00-111-3208	26	5
5970-00-815-1295	15	23	5975-00-111-3208	29	5
5970-00-815-1295	31	28	5975-00-111-3208	30	5
5970-00-815-1295	33	80	5975-00-111-3208	31	50
5970-00-881-3556	33	47	5975-00-111-3208	32	5
5970-00-914-3117	1	3	5975-00-111-3208	36	3
5970-00-914-3117	1	14	5975-00-111-3208	106	7
5970-04-914-3117	1	30	5975-00-156-3253	35	17
5970-00-914-3117	1	40	5975-00-421-6952	5	9
5970-00-914-3117	15	22	5975-00-451-5001	16	6
5970-00-914-3117	94	10	5975-00-570-9598	16	12
5970-00-914-3117	103	2	5975-00-614-9669	41	
5970-00-914-3117	104	8	5975-00-727-5153	10	4
5970-00-914-3117	105	4	5975-00-727-5153	33	71
5970-00-914-3118	1	5	5975-00-727-5153	33	145
5970-00-914-3118	1	9	5975-00-727-5153	34	8
5970-00-914-3118	1	31	5975-00-727-5153	91	3
5970-00-914-3118	1	41	5975-00-727-5153	94	9
5970-00-914-3118	94	11	5975-00-727-5153	95	4
5970-00-914-3118	104	9	5975-00-727-5153	96	3
5970-00-914-3118	106	2	5975-00-727-5153	101	6
5970-00-914-3118	107	5	5975-00-727-5153	102	4
5970-00-915-6133	4	7	5975-00-727-5153	103	3

SECTION IV. NATIONAL STOCK NUMBER AND REFERENCE INDEX (CONT.)

STOCK NUMBER	FIG. No.	ITEM No.	STOCK NUMBER	FIG. No.	ITEM No.
5975-00-727-5153	105	7	6115-00-480-9472	97	
5975-00-727-5153	107	4	6115-00-564-0067	25	
5975-00-780-3531			6115-00-564-0074	27	
5975-00-780-3531	28	4	6115-00-602-5972	42	4
5975-00-879-7234	3	6	6115-00-602-5973	39	8
5975-00-980-2342	64	58	6115-00-610-2088	31	44
5975-01-208-8984	16	5	6115-00-610-2092	33	63
5977-00-078-9102	90	55	6115-00-610-2116	27	
5977-00-456-6097	90	54	6115-00-610-2119	99	9
5977-00-733-9909	64	13	6115-00-610-2128	100	
5977-01-011-1154	57	21	6115-00-610-2142	101	
5995-00-701-6934	90	13	6115-00-611-8018	1	24
5998-01-256-1741	31	21	6115-00-611-8092	56	7
5999-00-003-4578	18	60	6115-00-830-6462	83	35
5999-00-003-4579	18	61	6115-01-007-6957	15	
5999-00-031-3941	18	28	6115-01-021-2164	10	
5999-00-212-3555	22	61	6115-01-024-5849	1	58
5999-00-255-9313	18	65	6115-01-024-5955	18	
5999-00-332-0010	93	37	6115-01-075-6616	62	8
5999-00-202-4249	16	3	6115-01-151-7130	13	7
6105-00-092-8290	58	9	6115-01-237-3654	42	
6110-00-092-5116	8		6130-00-365-4477	22	99
6110-00-199-1278	7	22	6140-01-010-1272	1	1
6110-00-201-6015	27	46	6140-01-010-1273		
6110-00-201-8315	8		6140-01-010-1273	1	7
6110-00-202-2888	8	64	6140-01-010-4079	1	12
6110-00-202-2891	22		6140-01-210-1964	1	21
6110-00-363-3973	33	76	6145-00-284-0657	84	43
6110-00-363-3974	33	76	6145-00-548-0969	7	
6110-00-370-5864	22	73	6145-00-577-3420	33	
6115-00-033-6623	5	3	6145-00-578-6595	18	95
6115-00-188-5333	35		6145-00-578-6595	20	3
6115-00-204-1728	22	33	6145-00-578-6602	9	2
6115-00-204-1729	22	33	6145-00-578-6602	16	9
6115-00-222-8246	22		6145-00-578-6802	25	33
6115-00-279-3198	9		6145-00-578-602	25	44
6115-00-363-3957	33		6145-00-578-6802	27	85
6115-00-368-8200	38		6145-00-57846802	31	45
6115-00-368-8201	31		6145-00-578-6602	33	9
6115-00-368-8202	31		6145-00-578-6602	33	70
6115-00-370-2726	33		6145-00-578-6602	33	146
6115-00-370-2738	42	3	6145-00-578-6605	3	8
6115-00-370-2749	44		6145-00-578-6605	4	7
6115-00-370-2797	46		6145-00-578-6605	9	1
6115-00-370-2801	45		6145-00-578-6605	10	6
6115-00-370-2823	43		6145-00-578-6605	11	3
6115-00-433-6726	38		6145-00-578-6605	12	4
6115-00-463-9083	88		6145-00-578-6605	15	8
6115-00-463-9085	92		6145-00-578-6605	16	13
6115-00-463-9088	98		6145-00-578-6605	17	3
6115-00-463-9094	97		6145-00-578-6605	26	4

TM 9-6115-465-24P
 TO 35C2-3-446-4
 NAVFAC P-8-625-24P
 SL-4-06858B/06859D

SECTION IV. NATIONAL STOCK NUMBER INDEX(CONT.)

STOCK NUMBER	FIG. No.	ITEM No.	STOCK NUMBER	FIG. No.	ITEM No.
6145-00-578-6605	27	84	6210-00-813-8265	7	10
6145-00-578-6605	28	3	6210-00-831-8247	8	47
6145-00-578-6605	29	3	6210-00-935-6919	8	18
6145-00-578-6605	30	3	6210-00-990-4637	7	8
6145-00-578-6605	31	31	6240-00-143-3049	99	35
6145-00-578-6605	32	4	6240-00-155-7836	7	9
6145-00-578-6605	34	3	6240-00-155-7838	8	19
6145-00-578-6605	36	2	6240-00-155-8714	8	44
6145-00-578-6605	89	14	6240-00-155-8714	8	55
6145-00-578-6605	91	4	6240-00-155-8714	89	7
6145-00-578-6605	93	14	6240-00-155-8714	93	11
6145-00-578-6605	94	6	6240-00-155-8714	93	13
6145-00-578-6605	95	3	6305-00-068-0500	31	1
6145-00-578-6605	96	4	6230-00-143-3049	99	35
6145-00-578-6605	99	13	6240-00-143-3060	8	48
6145-00-578-6605	99	16	6620-00-436-6575	51	
6145-00-578-6605	99	19	6620-00-841-1892	75	8
6145-00-578-6605	99	22	6620-00-857-0662	8	7
6145-00-578-6605	99	25	6620-01-154-8425	63	1
6145-00-5786605	99	28	6620-01-005-4879	8	6
6145-00-578-6605	101	5	6625-00-003-0973	8	30
6145-00-57&6605	103	4	6625-00-003-0974	8	30
6145-00-578-6605	044	2	6625-00-003-0975	8	15
6145-00-578-6605	104	4	6625-00-003-0975	7	
6145-00-578-6605	105	5	6625-00-004-8066	8	16
6145-00-578-7513	102	2	6625-00-081-5840	8	16
6145-00-578-7514	15	7	6625-00-190-4868	53	24
6145-00-578-7514	10	10	6625-00-869-3141	8	9
6145-00-578-7514	27	83	6625-00-869-3144	8	17
6145-00-578-7514	89	13	6625-00-892-4342	27	39
6145-00-578-7514	91	5	6625-00-089-8842	8	10
6145-00-578-7514	94	7	6680-00-198-7058	78	1
6145-00-578-7514	96	5	6680-00-363-4001	84	20
6145-00-620-5585	107	3	6680-00-606-5022	56	5
6145-00-643-0647	22	97	6680-00-857-0656	8	8
6145-00643-0647	22	110	6685-00-814-5271	75	11
6145-00-643-0647	35	18	9390-00-865-8270	64	78
6145-00643-0647	35	24	9505-00-221-2650	56	12
6145-00-643-6642	22	98	9505-00-221-2650	59	1
6145-00-805-3354	1	6	9505-00-473-6379	73	5
6145-00-805-3354	1	11	9905-00-804-3814	84	
6145-00-805-3354	1	16	9905-00-814-5271	75	11
6145-00-805-3354	1	34	9905-01-049-0144	21	
6145-00-805-3354	1	43			
6145-01-015-9469	87	2			
6150-00-665-7230	8	62			
6210-00-686-4999	8	43			
6210-00-686-4999	93	10			
6210-00-688-5088	8	54			
6210-00-688-5088	89	8			
6210-00-688-5088	93	12			

SECTION IV. NATIONAL STOCK NUMBER AND REFERENCE INDEX (CONT.)

Reference Number	Mfg. Code	Fig. No.	Item No.	Reference Number	Mfg. Code	Fig. No.	Item No.
AGS40	71400	57	17	A2631	80684	90	59
ALA20S	19728	57	25	A2631	80684	90	60
ALC21E	19728	57	35	A2657	80684	90	58
ALE1013AS	19728	57	21	A2684	80684	90	32
ALU1045DS	19728	57	22	A2714	80684	90	68
ANJ1002S	19728	57	26	A2757	80684	90	18
ANJ 1003	19728	57	40	A2791	80684	90	63
ANJ1004AS	19728	57	30	A2796	80684	90	3
ANJ10045	19728	57	29	A2822	80684	90	57
ANJ1034S	19728	57	16	A2823	80684	90	34
ANJ2046	19728	57	36	A2328	80684	90	66
ANJ3008	19728	57	28	A2829	80684	90	37
ANJ33	19728	57	19	A2837	80684	90	20
ANJ7001	68505	57		A2841	80684	90	6
AN427-4C6	88044	8	80	A2847	80684	90	30
AN6227-12	88044	53	12	A2862	80684	90	62
AN6235-2A	88044	56	13	A2889	80684	90	38
AN6246-27	88044	56	14	A2895	80684	90	39
AN817-5	88044	85	9	A2896	80684	90	40
AN917-10	88044	92	28	A2897	80684	90	42
A1OS	05657	51	15	A2898-1	80684	90	45
A10	06037	51	17	A2899	80684	90	50
A2010	80684	90	13	A2900	80684	90	47
A2013	80684	90	12	A2901	80684	90	48
A2015	80684	90	5	A2902	80684	90	46
A2090	80684	90	11	A2903	80684	90	41
A2091	80684	90	10	A2904	80684	90	
A2092	80684	90	15	A2905	80684	90	51
A2096	80684	90	19	A2928	80684	90	49
A2137	80684	90	9	A2930	80684	90	53
A2142	80684	90	36	A2931	80684	90	52
A2154	80684	90	21	A2932	80684	90	44
A2170	80684	90	26	A400-3	80684	90	5
A2172	80684	90	2	A400-4	80684	90	5
A2172	80684	90	29	B2055	80684	90	27
A2173	80684	90	4	B2070	80684	90	8
A2204	80684	90	31	B2117	80684	90	16
A2238	80684	90	14	B2794	80684	90	
A2322	80684	90	7	B2795	80684	90	
A2393	80684	90	17	B2798	80684	90	56
A2480	80684	90	54	B2856	80684	90	
A2481	80684	90	55	B2859	80684	90	33
A2602	80684	90	22	B2894	80684	90	
A2603	80684	90	23	B2929	80684	90	43
A2604	80684	90	25	B301EA	74063	21	43
A2605	80684	90	24	CA36KFW103	81349	21	45
A2610	80684	90	65	CA36KFW103	81349	33	32
A2612	80684	90	64	CA36KFW103	81349	21	44
A2615	80684	90	59	CA36KFW103	81349	33	33

SECTION IV. NATIONAL STOCK NUMBER AND REFERENCE INDEX (CONT.)

Reference Number	Mfg. Code	Fig. No.	Item No.	Reference Number	Mfg. Code	Fig. No.	Item No.
CSR13E106ML	81349	33	122	JAN1 N4247	81349	33	119
CSR13G684ML	81349	33	137	JAN1190R	81340	46	5
CO-04HDF4-16-0500	81349	87	2	JAN2N2222A	81349	33	112
CO-04HDF4-18-0415	81349	100	2	JAN2N2905A	81349	33	107
CO-04HDF4-18-0415	81349	101	2	JAN2N4948	81349	33	111
C1126PL	73370	48	7	JAN2N689	81349	33	81
C1126PL	73370	49	8	JAN1N3189	81349	7	30
C177	59730	15	20	JAN1N4385	14433	22	64
C2583	80684	90	67	JANTXIN5616	81349	26	45
C2691	80684	90	69	JM15AWD	15605	99	29
C2797	80684	90	35	KIN5112-8112	07322	53	20
C3069X8X6	79470	88	6	K48181-15	63743	22	49
C5115X5	79470	85	13	K48181-3500	63743	22	75
C5115X5	79470	85	20	K48181-510	63743	22	51
C5115X6	79470	55	5	K48181-5100	63743	22	80
C5255X4X4	79740	55	19	K48181-5100	63743	22	67
C85-2005	30554	88	39	K48181-5100	63743	22	75
D-2310-060	04394	42	5	LC1 RN2	81349	7	8
D-298-ERX37	28265	65		LH73-1	81349	7	10
DBMFC633-ILK	84760	67	6	LN5635	35510	18	86
FA1493FFF30000	01276	87	3	MEP005AWF	36024	88	
FS92TYPE1STYLE9S	81348	22	92	MEP005AWM	30554	97	
FHN26G1	81349	57	18	MILC20696TYPE1CLAS	81349	5	10
FHN26G1	81349	57	18	MILG16491TYPE1CLAS	81349	5	12
FHN26G2	81349	7	11	MILH8794-5	81349	85	3
FHN26G2	81349	93	8	MILH8794-5	81349	85	7
FH0420-8C1	46384	33	31	MILH8794-5	81349	85	17
F02A250V1AS	81349	7	11	MILH8794-5	81349	88	19
F02A250V2AS	81349	93	9	MILH8794-5	81349	63	12
GK0023	09527	54	21	MILH8794-5	81349	87	6
GM42	66295	75	1	MILH8794-6	81349	55	3
GR32	19728	57	39	MILH8794-6	81349	55	9
GS3-4	57771	31	25	MILH8794-6	81349	55	13
G376-58	98410	1	33	MILH8794-8	81349	63	6
IN198PA	81349	46	5	MILH8794-8	81349	63	9
IN4385	14433	22	74	MILH8794-8	81349	87	3
IN4385	14433	22	88	MILH8794-8	81349	87	16
IN47722	80131	22	56	MILH8794-8	81349	92	3
JANIN1190	81349	46	4	MILH8794-8	81349	92	11
JAN1N1190OR	81349	46	5	MILH8794-8	81349	92	16
JAN1N204A	81349	33	11	MILH8794-8	96906	63	12
JAN1N1204A	81349	93	18	MILI16878-2-20-9	81349	22	98
JAN1N1204RA	81349	33	12	MILI23053-5-CLASS1	81349	15	22
JAN1N1204RA	81349	93	19	MILI23053-5-CLASS1	81349	103	2
JAN1N3020B	81349	33	123	MIL123053-5-CLASS1	81349	104	8
JAN1N3031B	81349	33	113	MIL123053-5-CLASS1	81349	104	9
JAN1 N3611	81349	33	98	MIL123053-5-CLASS1	81349	105	4
JAN1N3826A	81349	33	101	MIL123053-5-CLASS1	81349	106	2
JAN1N4246	81349	33	127				

SECTION IV. NATIONAL STOCK NUMBER AND REFERENCE NUMBER INDEX (CONT.)

REFERENCE NO.	MFG. CODE	FIG. NO.	ITEM NO.	REFERENCE NO.	MFG. CODE	FIG. NO.	ITEM NO.
MILI23053-5-CLASS1	81349	107	5	MS171657	96906	2	6
MILI23053-5-CLASS13	81349	100	3	MS17412-16	96906	106	6
MILI1631TYPEFFORUA	81349	7	24	MS17412-6	96906	106	5
MILI1631TYPEFFORUA	81349	31	28	MS18066-11	96906	53	15
MILI1631TYPEFORMUA	81349	31	51	MS18154-59	96906	1	22
MILP79FORMTMTYPEPB	81349	35	29	MS18154-113	96906	79	5
MILR17343	81349	8	27	MS20427-4C4	96906	8	83
MILR17343	81349	14	4	MS20639-114	96906	1	15
MILR17343	81349	87	12	MS20659-104	96906	105	6
MILR670TYPE4CLASS2	81349	5	11	MS20659-104	96906	106	4
MILT3520	81349	85	19	MS20659-104	96906	107	2
MILT3520	81349	86	8	MS20659-114	96906	1	8
MILT3520COMPOTYPE	81349	85	10	MS20659-114	96906	1	32
MILT3520COMPOTYPE	81349	85	12	MS20659-114	96906	1	42
MILT3520COMPOTYPE3	81349	85	19	MS20659-124	96906	84	84
MILT3520COMPOTYPE3	81349	86	7	MS20659-130	96906	106	3
MILT3520COMPOTYPE3	81349	86	14	MS20659-144	96906	8	26
MILT3520COMPOTYPE3	81349	86	15	MS20659-144	96906	14	2
MILT3520COMPOTYPE3	81349	86	16	MS20659-144	96906	87	11
MILY1140CLASSFORM	81349	45	18	MS20659-145	96906	18	92
MILY1140CLASSFORM	81349	46	19	MS20659-145	96906	84	84
MILI23053-CLASS1	81349	22	111	MS20995020	96906	56	12
MILI23053-2CL1	81349	22	30	MS20995020	96906	59	1
MILI23053-2CL1	81349	22	31	MS21042-08	96906	67	13
MILI23053-5CLASS18	81349	1	3	MS21042-5	96906	84	24
MILI2353-2CLASS10	81349	35	16	MS21266-3N	96906	37	13
MSA200	81349	27	33	MS21266-3N	96906	37	14
MS086-2-12-9	81349	27	83	MS21301A0GR	96906	84	84
MS086-2-16-9	81349	27	84	MS21318-1	96906	53	61
MS086-2-18-9	81349	27	85	MS21318-21	96906	18	1
MS13486-1-12	81349	1	43	MS21318-22	96906	38	24
MS15567-1	96906	8	48	MS21318-7	96906	73	4
MS15579-4	96906	99	35	MS21333-100	96906	85	21
MS1595-842	96906	99	24	MS21333-100	96906	86	5
MS15975-810	96906	54	10	MS21333-102	96906	86	5
MS16562-62	96906	81	16	MS21333-102	96906	98	2
MS16624-93	96906	72	4	MS21333-109	96906	92	29
MS16625-1093	96906	53	18	MS21333-111	96906	86	28
MS16632-1056	96906	48	8	MS21333-113	96906	21	28
MS16996-12	96906	53	25	MS21333-113	96906	21	35
MS16997-10	96906	53	34	MS21333-126	96906	85	4
MS16997-143	96906	40	2	MS21333-48	96906	86	13
MS16997-30	96906	68	4	MS21333-50	96906	55	10
MS16997-30	96906	68	18	MS21333-67	96906	103	10
MS16997-9	96906	53	38	MS21333-68	96906	93	31
MS17143-6	96906	27	62	MS21333-69	96906	30	6
MS17143	96906	53	41	MS21333-71	96906	8	33
MS17157-10	96906	7	31	MS21333-71	96906	87	28
MS171572	96906	53	17	MS21333-71	96906	92	24

TM9-6115-465-24P
 TO 35C2-3-446-4
 NAVFACP-8-625-24P
 SL-4-06858B/06859D

SECTION IV. NATIONAL STOCK NUMBER AND REFERENCE NUMBER INDEX (CONT.)

REFERENCE NO.	MFG. CODE	FIG. NO.	ITEM NO.	REFERENCE NO.	MFG. CODE	FIG. NO.	ITEM NO.
MS21333-71	96906	97	9	MS2503-106	96906	99	27
MS21333-75	96906	8	36	MS25036-106	96906	103	5
MS21333-75	96906	97	11	MS25036-106	96906	104	3
MS21333-77	96906	87	31	MS25036-108	96906	9	9
MS21334-30	96906	84	42	MS25036-108	96906	10	9
MS24006/2-321	81349	31	26	MS25036-108	96906	15	9
MS24243-1D404	96906	97	1	MS25036-108	96906	27	69
MS24587-5	96906	63	11	MS25036-108	96906	34	9
MS24587-5	96906	85	2	MS25036-110	96906	10	7
MS24587-5	96906	85	6	MS25036-110	96906	15	15
MS24587-5	96906	85	16	MS25036-110	96906	34	7
MS24587-5	96906	87	5	MS25036-111	96906	89	10
MS24587-5	96906	88	18	MS25036-112	96906	15	13
MS24587-6	96906	55	2	MS25036-112	96906	102	3
MS24587-6	96906	55	8	MS25036-113	96906	10	8
MS24587-6	96906	55	12	MS25036-113	96906	27	64
MS24587-8	96906	63	5	MS25036-114	96906	15	14
MS24587-8	96906	63	8	MS25036-115	96906	104	6
MS24587-8	96906	63	11	MS25036-118	96906	20	4
MS24587-8	96906	88	2	MS25036-125	96906	18	93
MS24587-8	96906	88	15	MS25036-125	96906	20	1
MS24587-8	96906	92	2	MS25036-125	96906	20	2
MS24587-8	96906	92	10	MS25036-145	96906	31	29
MS24587-8	96906	92	15	MS25036-149	96906	9	5
MS24665-136	96906	61	4	MS25036-149	96906	25	42
MS24665-283	96906	97	71	MS25036-149	96906	27	66
MS24665-357	96906	90	9	MS25036-149	96906	31	49
MS24665-623	96906	97	47	MS25036-15	96906	27	68
MS24680-6	96906	48	10	MS25036-150	96906	9	7
MS25036-101	96906	22	109	MS25036-150	96906	33	68
MS25036-102	96906	9	4	MS25036-153	96906	3	9
MS25036-102	96906	25	32	MS25036-153	96906	4	6
MS25036-102	96906	25	41	MS25036-153	96906	9	11
MS25036-102	96906	31	48	MS25036-153	96906	10	5
MS25036-102	96906	33	10	MS25036-153	96906	12	1
MS25036-102	96906	33	67	MS25036-153	96906	15	10
MS25036-102	96906	33	148	MS25036-153	96906	34	4
MS25036-103	96906	9	6	MS25036-153	96906	89	11
MS25036-106	96906	9	8	MS25036-153	96906	94	4
MS25036-106	96906	15	23	MS25036-153	96906	95	6
MS25036-106	96906	27	63	MS25036-153	96906	104	7
MS25036-106	96906	31	30	MS25036-154	96906	9	10
MS25036-106	96906	89	9	MS25036-154	96906	34	6
MS25036-106	96906	94	3	MS25036-155	96906	12	2
MS25036-106	96906	99	12	MS25036-156	96906	15	11
MS25036-106	96906	99	15	MS25036-156	96906	27	68
MS25036-106	96906	99	18	MS25036-156	96906	89	12
MS25036-106	96906	99	21	MS25036-156	96906	94	5
MS25036-106	96906	99	24	MS25036-156	96906	102	1

SECTION IV. NATIONAL STOCK NUMBER AND REFERENCE NUMBER INDEX (CONT.)

REFERENCE NO.	MFG. CODE	FIG. NO.	ITEM NO.	REFERENCE NO.	MFG. CODE	FIG. NO.	ITEM NO.
MS25036-157	96906	27	67	MS27183-10	96906	98	15
MS25036-157	96906	45	19	MS27183-11	96906	22	54
MS25036-157	96906	46	20	MS27183-12	96906	37	11
MS25043-180	96906	27	23	MS27183-12	96906	37	19
MS25043-180	96906	99	8	MS27183-12	96906	37	24
MS25043-220	96906	27	22	MS27183-12	96906	51	31
MS25043-280	96906	98	13	MS27183-12	96906	56	4
MS25043-320	96906	99	7	MS27183-12	96906	57	5
MS25068	96906	8	51	MS27183-12	96906	84	25
MS25068-23	96906	8	45	MS27183-12	96906	84	37
MS25126E2	96906	31	7	MS27183-12	96906	86	11
MS25166-1	96906	8	86	MS27183-14	96906	1	23
MS25201-6	96906	8	56	MS27183-14	96906	13	102
MS25224-1	96906	8	46	MS27183-14	96906	13	107
MS25231-313	96906	8	44	MS27183-14	96906	51	4
MS25231-313	96906	8	55	MS27183-14	96906	51	26
MS25231-313	96906	89	7	MS27183-17	96906	37	3
MS25231-313	96906	93	11	MS27183-17	96906	50	16
MS25231-313	96906	93	13	MS27183-17	96906	50	22
MS25237-327	96906	7	9	MS27183-17	96906	50	27
MS25244-15	96906	3	13	MS27183-17	96906	50	32
MS25244-15	96906	89	6	MS27183-17	96906	50	37
MS25244-20	96906	93	7	MS27183-17	96906	50	42
MS25244-7 1-2	96906	7	1	MS27183-17	96906	57	11
MS25251-12	96906	15	19	MS27183-17	96906	85	28
MS25251-12	96906	95	2	MS27183-17	96906	97	5
MS25251-15	96906	11	5	MS27183-23	96906	38	4
MS25251-15	96906	15	18	MS27183-41	96906	35	8
MS25251-15	96906	17	5	MS27183-5	96906	22	36
MS25251-15	96906	26	3	MS27183-5	96906	22	41
MS25251-15	96906	28	5	MS27183-5	96906	22	46
MS25251-15	96906	29	4	MS27183-5	96906	22	71
MS25251-15	96906	30	4	MS27183-5	96906	22	83
MS25251-15	96906	32	6	MS27183-5	96906	22	91
MS25251-15	96906	33	72	MS27183-5	96906	27	53
MS25251-15	96906	34	2	MS27183-6	96906	27	25
MS25251-15	96906	32	4	MS27183-6	96906	35	4
MS25251-15	96906	105		MS27183-6	96906	35	21
MS25251-16	96906	4	10	MS27183-6	96906	35	28
MS25251-16	96906	10	2	MS27183-6	96906	93	17
MS25251-16	96906	60	14	MS27183-6	96906	93	23
MS25251-8	96906	106		MS27183-7	96906	8	23
MS25331-2	96906	8	43	MS27183-7	96906	21	27
MS25331-2	96906	93	10	MS27183-7	96906	21	31
MS25331-4	96906	8	54	MS27183-7	96906	25	19
MS25331-4	96906	89	8	MS27183-7	96906	27	10
MS25331-4	96906	93	12	MS27183-7	96906	27	37
MS27040-4	96906	53	33	MS27183-7	96906	31	9
MS27144-1	96906	15	12	MS27183-8	96906	8	67

TM9-6115-465-24P
 TO 35C2-3-446-4
 NAVFACP-8-625-24P
 SL-4-06858B/06859D

SECTION IV. NATIONAL STOCK NUMBER AND REFERENCE NUMBER INDEX (CONT.)

REFERENCE NO.	MFG. CODE	FIG. NO.	ITEM NO.	REFERENCE NO.	MFG. CODE	FIG. NO.	ITEM NO.
MS27183-9	96906	1	38	MS3102R24-28	96906	27	75
MS27183-9	96906	13	60	MS3102R24-28	96906	31	47
MS27183-9	96906	25	3	MS3102R28-12P	96906	25	39
MS27183-9	96906	27	4	MS3102R28-12P	96906	107	1
MS27183-9	96906	31	3	MS3102R28-12S	96906	27	76
MS27183-9	96906	33	6	MS3102R28-9S	96906	94	1
MS27183-9	96906	47	11	MS3102R32-17P	96906	104	5
MS27183-9	96906	50	5	MS3102R32-6P	96906	104	1
MS27183-9	96906	85	33	MS3102R32-7P	96906	27	77
MS27188-10	96906	54	7	MS3102R36-7P	96906	9	12
MS27212-5-2	96906	13	62	MS3102R36-7S	96906	27	79
MS2720-6	96906	3	10	MS3106-518-4S	96906	101	3
MS28741-5-0150	96906	85	5	MS3106A24-28P	96906	16	4
MS28741-5-0220	96906	63	10	MS3106E14S2SC	96906	15	5
MS28741-5-0280	96906	85	15	MS3106F18-1S	96906	15	4
MS28741-5-0320	96906	85	1	MS3106F18-4S	96906	35	1
MS28741-5-0580	96906	88	17	MS3106F20-29S	96906	101	4
MS28741-5-2992	96906	87	4	MS3106F32-6S	96906	106	1
MS28741-6-0120	96906	55	7	MS3106R10SL-45	96906	16	11
MS28741-6-0160	96906	55	11	MS3106P10SL45C	96906	95	5
MS28741-6-0320	96906	55	1	MS3106R10SL4S	96906	15	6
MS28741-8-0080	96906	92	14	MS3106R10SL4SC	96906	32	2
MS28741-8-0190	96906	92	9	MS3106R14S-2P	96906	17	1
MS28741-8-0220	96906	63	10	MS3106R14S-53	96906	17	2
MS28741-8-0320	96906	63	7	MS3106R14S-65	96906	16	10
MS28741-8-0320	96906	88	14	MS3106R14S6P	96906	29	1
MS28741-8-0320	96906	92	1	MS3106R14S-6S	96906	29	2
MS28741-8-0344	96906	88	1	MS3106R18-1P	96906	33	64
MS28775-223	96906	56	15	MS3106R18-11P	96906	91	1
MS28778-4	96906	55	22	MS3106R18-11P	96906	96	1
MS28778-5	96906	55	23	MS3106R18-11S	96906	91	2
MS28778-6	96906	55	16	MS3106R18-11S	96906	96	2
MS3057-16A	96906	105	2	MS3106R18-4S	96906	6	3
MS3101R10SL4P	96906	47	13	MS3106R18-5P	96906	15	2
MS3102R14S2	96906	53	54	MS3106R20-27P	96906	11	1
MS3102R14S6P	96906	33	65	MS3106R20-27S	96906	11	2
MS3102R14S6S	96906	27	70	MS3106R20-29P	96906	4	4
MS3102R16-20P	96906	94	2	MS3106R20-29S	96906	10	3
MS3102R18-1S	96906	33	144	MS3106R20-29S	96906	16	1
MS3102R18-11P	96906	89	18	MS3106R20-29S	96906	36	1
MS3102R18-11SC	96906	27	71	MS3106R22-14S	96906	32	1
MS3102R18-11SC	96906	89	19	MS3106R22-14S	96906	34	1
MS3102R18-4P	96906	4	5	MS3106R24-28P	96906	27	21
MS3102R18-4P	96906	103	1	MS3106R24-28P	96906	28	1
MS3102R20-27S	96906	27	72	MS3106R24-28P	96906	32	3
MS3102R20-29P	96906	25	38	MS3106R24-28S	96906	28	2
MS3102R20-29S	96906	27	73	MS3106R28-12P	96906	26	2
MS3102R22-19S	96906	27	74	MS3106R28-12S	96906	26	1
MS3102R24-28P	96906	31	46	MS3106R28-9P	96906	95	1

SECTION IV. NATIONAL STOCK NUMBER AND REFERENCE INDEX (CONT.)

Reference Number	Mfg. Code	Fig. No.	Item No.	Reference Number	Mfg. Code	Fig. No.	Item No.
MS3106R32-17S	96906	100	1	MS35058-22	96906	8	53
MS3106R32-7S	96906	10	1	MS35058-22	96906	99	10
MS3106R36-7S	96906	30	1	MS35058-30	96906	8	58
MS3106R36-75	96906	15	1	MS35058-22	96906	89	5
MS3108R14S2S	96906	15	3	MS35058-23	96906	8	52
MS3108R28-12S	96906	105	1	MS35058-26	96906	7	13
MS3367-1-9	96906	7		MS35165-28	96906	35	22
MS3367-1-9	96906	9	3	MS35190-236	96906	3	3
MS3367-1-9	96906	15	16	MS35190-249	96906	73	6
MS3367-1-9	96906	22	112	MS35206-15	96906	61	1
MS3367-1-9	96906	94	8	MS35206-215	96906	25	25
MS3367-2-9	96906	35	17	MS35206-215	96906	99	6
MS3367-3-9	96906	16	6	MS35206-216	96906	33	62
MS3367-4-9	96906	10	4	MS35206-216	96906	33	142
MS3367-4-9	96906	33	71	MS35206-225	96906	7	18
MS3367-4-9	96906	33	145	MS35206-225	96906	8	68
MS3367-4-9	96906	34	8	MS35206-225	96906	27	77
MS3367-4-9	96906	91	3	MS35206-228	96906	8	77
MS3367-4-9	96906	96	3	MS35206-228	96906	31	23
MS3367-4-9	96906	94	9	MS35206-228	96906	33	78
MS3367-4-9	96906	95	4	MS35206-228	96906	33	84
MS3367-9	96906	101	6	MS35206-228	96906	33	87
MS3367-4-9	96906	102	4	MS35206-230	96906	33	90
MS3367-4-9	96906	103	3	MS35206-231	96906	3	5
MS3367-5-9	96906	1	29	MS35206-231	96906	25	15
MS3367-5-9	96906	4	9	MS35206-231	96906	25	30
MS3367-5-9	96906	7		MS35206-231	96906	27	31
MS3367-5-9	96906	11	4	MS35206-231	96906	31	33
MS3367-5-9	96906	12	3	MS35206-231	96906	31	37
MS3367-5-9	96906	15	17	MS35206-242	96906	33	18
MS3367-5-9	96906	17	4	MS35206-243	96906	22	11
MS3367-5-9	96906	18	94	MS35206-243	96906	22	24
MS3367-5-9	96906	20	2	MS35206-243	96906	25	27
MS3367-5-9	96906	25	43	MS35206-244	96906	27	35
MS3367-5-9	96906	26	5	MS35206-245	96906	33	26
MS3367-5-9	96906	27	80	MS35206-245	96906	4	6
MS3367-5-9	96906	28	4	MS35206-245	96906	8	12
MS3367-5-9	96906	29	5	MS35206-245	96906	8	22
MS3367-5-9	96906	30	5	MS35206-245	96906	8	29
MS3367-5-9	96906	31	50	MS35206-245	96906	8	35
MS3367-5-9	96906	32	5	MS35206-245	96906	8	38
MS3367-5-9	96906	36	3	MS35206-245	96906	8	60
MS3367-5-9	96906	105	7	MS35206-245	96906	25	20
MS3367-5-9	96906	106	7	MS35206-245	96906	27	11
MS3367-5-9	96906	107	4	MS35206-245	96906	31	10
MS3367-7-9	96906	16	12	MS35206-245	96906	33	21
MS3420-12	96906	16	8	MS35206-245	96906	33	40
MS3420-16	96906	16	9	MS35206-245	96906	33	56
MS3420-16	96906	105	3				

SECTION IV. NATIONAL STOCK NUMBER AND REFERENCE INDEX (CONT.)

Reference Number	Mfg. Code	Fig. No.	Item No.	Reference Number	Mfg. Code	Fig. No.	Item No.
MS35206-245	96906	33	59	MS35335-32	96906	93	16
MS35206-245	96906	65	35	MS35338-103	96906	18	38
MS35206-246	96906	27	38	MS35338-104	96906	18	22
MS35206-263	96906	98	8	MS35338-135	96906	53	35
MS35206-265	96906	64	60	MS35338-135	96906	53	39
MS35206-302	96906	21	51	MS35338-39	96906	53	43
MS35206-338	96906	8	32	MS35338-40	96906	53	32
MS35207-263	96906	33	3	MS35338-40	96906	53	53
MS35207-263	96906	33	7	MS35338-40	96906	53	58
MS35207-263	96906	33	14	MS35338-41	96906	7	19
MS35207-263	96906	33	26	MS35338-41	96906	8	70
MS35207-263	96906	33	36	MS35338-41	96906	22	35
MS35207-263	96906	33	43	MS35338-41	96906	22	40
MS35207-263	96906	33	52	MS35338-41	96906	22	45
MS35207-263	96906	33	75	MS35338-41	96906	22	58
MS35223-62	96906	22	84	MS35338-41	96906	22	70
MS35225-17	96906	89	17	MS35338-41	96906	22	82
MS35265-15	96906	53	31	MS35338-41	96906	22	90
MS35263-17	96906	53	57	MS35338-41	96906	27	48
MS35265-18	96906	53	52	MS35338-41	96906	35	3
MS35265-2	96906	53	42	MS35338-41	96906	35	21
MS35265-28	96906	22	60	MS35338-41	96906	35	27
MS35265-30	96906	22	37	MS35338-42	96906	18	11
MS35265-30	96906	22	42	MS35338-42	96906	22	25
MS35265-30	96906	22	47	MS35338-42	96906	35	7
MS35265-41	96906	35	12	MS35338-42	96906	35	13
MS35265-55	96906	35	10	MS35338-43	96906	53	26
MS35265-68	96906	67	7	MS35338-44	96906	1	37
MS35265-83	96906	22	55	MS35338-44	96906	2	4
MS35265-96	96906	74	20	MS35338-44	96906	5	2
MS35307-308	96906	53	2	MS35338-44	96906	7	4
MS35307-310	96906	54	9	MS35338-44	96906	8	2
MS35333-104	96906	18	7	MS35338-44	96906	13	2
MS35333-106	96906	18	5	MS35338-44	96906	13	9
MS35333-107	96906	18	27	MS35338-44	96906	13	15
MS35333-38	96906			MS35338-44	96906	13	20
MS35333-40	96906	38	6	MS35338-44	96906	13	29
MS35333-40	96906	38	9	MS35338-44	96906	13	34
MS35333-40	96906	38	12	MS35338-44	96906	13	39
MS35333-40	96906	38	16	MS35338-44	96906	13	45
MS35333-40	96906	41	2	MS35338-44	96906	13	51
MS35333-40	96906	44	5	MS35338-44	96906	13	57
MS35333-40	96906	45	3	MS35338-44	96906	13	64
MS35333-40	96906	45	7	MS35338-44	96906	13	67
MS35333-40	96906	45	16	MS35338-44	96906	13	73
MS35333-40	96906	46	7	MS35338-44	96906	13	77
MS35333-42	96906	38	19	MS35338-44	96906	13	81
MS35333-44	96906	40	3	MS35338-44	96906	13	84
MS35333-31	96906	22	12	MS35338-44	96906	13	89

SECTION IV. NATIONAL STOCK NUMBER AND REFERENCE NUMBER INDEX (CONT.)

REFERENCE NO.	MFG. CODE	FIG. NO.	ITEM NO.	REFERENCE NO.	MFG. CODE	FIG. NO.	ITEM NO.
MS35338-44	96906	13	94	MS35338-45	96906	60	4
MS35338-44	96906	21	2	MS35338-45	96906	74	16
MS35338-44	96906	21	13	MS35338-46	96906	1	18
MS35338-44	96906	21	24	MS35338-46	96906	13	100
MS35338-44	96906	21	37	MS35338-46	96906	13	105
MS35338-44	96906	22	5	MS35338-46	96906	22	2
MS35338-44	96906	22	8	MS35338-46	96906	48	2
MS35338-44	96906	22	53	MS35338-46	96906	48	22
MS35338-44	96906	23	3	MS35338-46	96906	49	2
MS35338-44	96906	24	2	MS35338-46	96906	49	12
MS35338-44	96906	25	2	MS35338-46	96906	51	2
MS35338-44	96906	27	3	MS35338-46	96906	51	22
MS35338-44	96906	27	40	MS35338-46	96906	51	24
MS35338-44	96906	31	2	MS35338-46	96906	75	5
MS35338-44	96906	33	79	MS35338-46	96906	75	17
MS35338-44	96906	47	6	MS35338-46	96906	76	2
MS35338-44	96906	47	9	MS35338-46	96906	78	3
MS35338-44	96906	50	2	MS35338-46	96906	78	12
MS35338-44	96906	51	9	MS35338-46	96906	80	4
MS35338-44	96906	52	2	MS35338-46	96906	80	16
MS35338-44	96906	52	5	MS35338-46	96906	83	2
MS35338-44	96906	53	8	MS35338-46	96906	83	39
MS35338-44	96906	53	14	MS35338-46	96906	97	15
MS35338-44	96906	54	6	MS35338-46	96906	97	68
MS35338-44	96906	56	9	MS35338-47	96906	2	9
MS35338-44	96906	56	17	MS35338-48	96906	37	2
MS35338-44	96906	84	9	MS35338-48	96906	24	9
MS35338-44	96906	84	16	MS35338-48	96906	50	14
MS35338-44	96906	84	33	MS35338-48	96906	50	20
MS35338-44	96906	85	31	MS35338-48	96906	50	25
MS35338-44	96906	86	10	MS35338-48	96906	50	29
MS35338-44	96906	88	37	MS35338-48	96906	50	35
MS35338-44	96906	92	18	MS35338-48	96906	50	39
MS35338-44	96906	93	2	MS35338-48	96906	51	6
MS35338-44	96906	93	4	MS35338-48	96906	53	65
MS35338-44	96906	98	5	MS35338-48	96906	54	3
MS35338-44	96906	98	29	MS35338-48	96906	57	9
MS35338-45	96906	13	25	MS35338-48	96906	57	13
MS35338-45	96906	13	97	MS35338-48	96906	79	7
MS35338-45	96906	13	110	MS35338-48	96906	80	7
MS35338-45	96906	33	2	MS35338-48	96906	84	29
MS35338-45	96906	37	10	MS35338-48	96906	97	4
MS35338-45	96906	37	17	MS35336-48	96906	97	11
MS35338-45	96906	37	22	MS35338-50	96906	63	20
MS35338-45	96906	47	19	MS35338-50	96906	81	22
MS35338-45	96906	51	30	MS35338-51	96906	38	2
MS35338-45	96906	56	1	MS35482-12	96906	63	17
MS35338-45	96906	56	2	MS35489-20	96906	97	26
MS35338-45	96906	57	2	MS35489-35	96906	93	29

TM9-6115-465-24P
 TO 35C2-3-446-4
 NAVFACP-8-625-24P
 SL-4-06858B/06859D

SECTION IV. NATIONAL STOCK NUMBER AND REFERENCE NUMBER INDEX (CONT.)

REFERENCE NO.	MFG. CODE	FIG. NO.	ITEM NO.	REFERENCE NO.	MFG. CODE	FIG. NO.	ITEM NO.
MS35489-38	96906	37	13	MS35756-17	96906	81	20
MS35490-11	96906	3	15	MS35756-35	96906	81	25
MS35645-1	96906	84	7	MS35756-35	96906	82	3
MS35649-202	96906	64	62	MS35770-1	96906	75	8
MS35649-202	96906	98	14	MS35782-4	96906	47	17
MS35649-242	96906	25	23	MS35782-4	96906	48	5
MS35649-242	96906	27	12	MS35782-4	96906	49	6
MS35649-242	96906	27	14	MS35802-2	96906	63	37
MS35649-242	96906	27	24	MS35823-6C	96906	8	82
MS35649-242	96906	98	23	MS35840-1	96906	51	28
MS35649-262	96906	1	25	MS35842-12	96906	88	33
MS35649-262	96906	3	10	MS35842-12	96906	63	17
MS35649-262	96906	22	34	MS35842-13	96906	51	11
MS35649-262	96906	22	39	MS35842-13	96906	51	13
MS35649-262	96906	22	44	MS35842-14	96906	92	35
MS35649-262	96906	22	57	MS35842-16	96906	84	13
MS35649-262	96906	22	69	MS35842-16	96906	88	38
MS35649-262	96906	22	81	MS35930-2	96906	88	21
MS35649-262	96906	22	89	MS39154-4	96906	85	39
MS35649-262	96906	25	21	MS39212-3	96906	66	8
MS35649-262	96906	27	17	MS39231G6	96906	55	15
MS35649-262	96906	31	15	MS39321T8	96906	92	36
MS35649-262	96906	31	30	MS39321V5	96906	53	23
MS35649-262	96906	35	2	MS39321V6	96906	55	17
MS35649-262	96906	35	19	MS39321W5	96906	55	22
MS35649-262	96906	35	26	MS39326-26	96906	84	2
MS35649-262	96906	53	29	MS39326-8	96906	86	1
MS35649-262	96906	99	3	MS39326-8	96906	51	15
MS35649-262	96906	99	31	MS39326-14	96906	2	1
MS35649-282	96906	35	6	MS39326-14	96906	2	1
MS35649-282	96906	98	7	MS39347-5	96906	21	20
MS35649-282	96906	67	14	MS434631-3	30554	16	2
MS35649-2252	96906	23	4	MS45904-68	96906	46	3
MS35649-2252	96906	54	5	MS45904-68	96906	46	6
MS35650-302	96906	13	70	MS45904-69	96906	21	42
MS35650-302	96906	21	41	MS45904-69	96906	27	3A
MS35650-302	96906	68	3	MS45904-72	96906	42	2
MS35650-302	96906	68	22	MS45904-72	96906	43	2
MS35650-302	96906	89	1	MS45904-72	96906	44	2
MS35650-302	96906	92	22	MS45904-76	96906	38	21
MS35650-302	96906	91	15	MS45904-76	96906	38	23
MS35650-3385	96906	18	37	MS45904-76	96906	79	9
MS35660-3252	96906	53	4	MS5086-2-16-19	96906	31	31
MS35690-302	96906	88	26	MS51007-2	96906	22	26
MS35690-302	96906	88	29	MS51007-4	96906	22	27
MS35691-24	96906	97	14	MS51007-8	96906	22	28
MS35691-36	96906	21	8	MS51066-59	96906	57	7
MS35691-36	96906	21	19	MS51095-405	96906	102	10
MS35692-23	96906	59	6	MS5127B6	96906	55	15

SECTION IV. NATIONAL STOCK NUMBER AND REFERENCE INDEX (CONT.)

Reference Number	Mfg. Code	Fig. No.	Item No.	Reference Number	Mfg. Code	Fig. No.	Item No.
MS51321-2	96906	50	6	MS51967-2	96906	88	35
MS51504B&-4	96906	55	18	MS51967-2	96906	92	17
MS51509A5	96906	85	29	MS51967-23	96906	38	1
MS51813-4	96906	85	36	MS51967-26	96906	50	10
MS51815-36	96906	55	14	MS51967-5	96906	13	23
MS51815-37	96906	55	24	MS51967-5	96906	13	101
MSS1819-36	96906	85	35	MS51967-5	96906	13	115
MS51819-36	96906	85	39	MS51967-5	96906	37	16
MS51922-11	96906	84	36	MS51967-5	96906	37	21
MS51922-19	96906	21	6	MS51967-5	96906	34	9
MS51922-2	96906	53	1	MS51967-5	96906	48	16
MS51922-2	96906	54	11	MS51967-5	96906	84	27
MS51922-9	96906	57	4	MS51967-5	96906	84	38
MS51953-102	96906	84	4	MS51967-5	96906	85	9
MS51967-1	96906	2	8	MS51967-8	96906	1	17
MSS1967-1	96906	50	13	MS51967-8	96906	10	99
MSS1967-1	96906	50	19	MS51967-8	96906	14	101
MS51967-1	96906	50	24	MS51967-8	96906	22	1
MS51967-1	96906	50	28	MS51967-8	96906	51	1
MS51967-1	96906	50	55	MS51967-8	96906	51	23
MS51967-1	96906	50	39	MS51967-8	96906	83	1
MS51967-1	96906	57	8	MSS1968-14	96906	97	10
MS51967-1	96906	97	3	MS51968-8	96906	67	2
MS51967-2	96906	1	35	MS51968-8	96906	76	1
MS51967-2	96906	4	1	MS51968-8	96906	97	53
MS51967-2	96906	13	1	MS51976-37	96906	53	56
MS51967-2	96906	13	8	MS51977-22	96906	53	30
MS51967-2	96906	13	14	MS52130A06R	96906	84	
MS51967-2	96906	13	19	MS52149-1	96906	1	21
MS51967-2	96906	13	38	MS57523-003	96906	7	20
MS51967-2	96906	13	44	MS57523-003	96906	8	72
MS51967-2	96906	13	50	MS70725-8	96906	23	2
MS51967-2	96906	13	56	MS75004-1	96906	1	4
MS51967-2	96906	13	75	MS75004-1	96906	1	10
MS51967-2	96906	13	79	MS75004-2	96906	1	2
MS51967-2	96906	13	85	MS75004-2	96906	1	13
MS51967-2	96906	13	91	MS75009-19	96906	33	46
MS51967-2	96906	21	23	MS75009-3	96906	33	47
MSS1967-2	96906	21	36	MS75009-33	96906	27	27
MS51967-2	96906	22	52	MS75009-33	96906	33	53
MS51967-2	96906	24	1	MS75009-5	96906	33	45
MS51967-2	96906	27	40	MS75009-13	96906	8	25
MS51967-2	96906	41	1	MS75009-13	96906	87	10
MS51967-2	96906	47	4	MS9020-02	96906	53	10
MS51967-2	96906	47	8	MS9020-02	96906	53	48
MS51967-2	96906	50	1	MS90725-1	96906	45	1
MS51967-2	96906	56	8	MS90725-1	96906	45	15
MS51967-2	96906	56	16	MS90725-1	96906	46	1
MS51967-2	96906	84	8	MS90725-1	96906	46	15
MS51967-2	96906	85	30				

SECTION IV. NATIONAL STOCK NUMBER AND REFERENCE INDEX (CONT.)

Reference Number	Mfg. Code	Fig. No.	Item No.	Reference Number	Mfg. Code	Fig. No.	Item No.
MS90725-10	96906	54	8	MS90725-3	96906	38	8
MS90725-10	96906	65	3	MS90725-3	96906	38	11
MS90725-107	96906	24	8	MS90725-3	96906	38	15
MS90725-1	96906	79	6	MS90725-3	96906	44	4
MS90725-111	96906	97	6	MS90725-3	96906	47	5
MS90725-113	96906	41	1	MS90725-3	96906	47	10
MS90725-113	96906	50	14	MS90725-3	96906	50	4
MS90725-113	96906	50	21	MS90725-3	96906	51	8
MS90725-113	96906	50	26	MS90725-3	96906	52	1
MS90725-113	96906	50	31	MS90725-3	96906	52	1
MS90725-113	96906	50	36	MS90725-3	96906	84	10
MS90725-113	96906	50	41	MS90725-3	96906	84	15
MS90725-113	96906	54	4	MS90725-3	96906	84	32
MS90725-115	96906	37	1	MS90725-3	96906	85	32
MS90725-117	96906	57	10	MS90725-3	96906	93	1
MS90725-117	96906	57	12	MS90725-3	96906	93	3
MS90725-177	96906	53	64	MS90725-3	96906	94	28
MS90725-12	96906	21	25	MS90725-31	96906	60	3
MS90725-14	96906	45	6	MS90725-32	96906	13	26
MS90725-14	96906	46	6	MS90725-32	96906	13	96
MS90725-15	96906	56	10	MS90725-32	96906	13	111
MS90725-163	96906	39	4	MS90725-32	96906	33	1
MS90725-166	96906	81	21	MS90725-32	96906	37	5
MS90725-188	96906	38	3	MS90725-32	96906	37	18
MS90725-3	96906	5	1	MS90725-32	96906	37	23
MS90725-3	96906	7	2	MS90725-32	96906	47	20
MS90725-3	96906	8	1	MS90725-32	96906	86	12
MS90725-3	96906	13	3	MS90725-32	96906	51	5
MS90725-3	96906	13	28	MS90725-32	96906	51	29
MS90725-3	96906	13	33	MS90725-32	96906	63	23
MS90725-3	96906	13	40	MS90725-32	96906	74	15
MS90725-3	96906	13	52	MS90725-32	96906	84	30
MS90725-3	96906	13	58	MS90725-34	96906	43	1
MS90725-3	96906	13	63	MS90725-34	96906	44	1
MS90725-3	96906	13	66	MS90725-35	96906	38	20
MS90725-3	96906	13	72	MS90725-36	96906	57	1
MS90725-3	96906	13	77	MS90725-36	96906	57	1
MS90725-3	96906	13	80	MS90725-38	96906	56	3
MS90725-3	96906	13	83	MS90725-39	96906	80	18
MS90725-3	96906	13	88	MS90725-58	96906	13	101
MS90725-3	96906	13	93	MS90725-58	96906	13	106
MS90725-3	96906	21	1	MS90725-58	96906	51	3
MS90725-3	96906	21	12	MS90725-58	96906	51	25
MS90725-3	96906	24	3	MS90725-59	96906	48	1
MS90725-3	96906	25	1	MS90725-59	96906	49	1
MS90725-3	96906	27	1	MS90725-6	96906	1	36
MS90725-3	96906	27	41	MS90725-6	96906	2	3
MS90725-3	96906	31	1	MS90725-6	96906	13	10
MS90725-3	96906	38	5	MS90725-6	96906	13	16

SECTION IV. NATIONAL STOCK NUMBER AND REFERENCE NUMBER INDEX (CONT.)

REFERENCE NO.	MFG. CODE	FIG. NO.	ITEM NO.	REFERENCE NO.	MFG. CODE	FIG. NO.	ITEM NO.
MS90725-6	96906	13	21	M16878-2-20-9	81349	35	24
MS90725-6	96906	13	46	M16878-4-22-9	81349	7	
MS90725-6	96906	13	59	M168787-2-20-9	81349	22	110
MS90725-6	96906	13	86	M22-03-00161FD	81349	8	40
MS90725-6	96906	13	90	M22-04-00181FD	81349	8	50
MS90725-6	96906	22	4	M22759-6-16-9	81349	105	5
MS90725-6	96906	22	7	M22759 6-16-9	81349	107	3
MS90725-6	96906	27	2	M23053/5-105D	81349	4	8
MS90725-6	96906	51	8	M23053/5-105-0	81349	7	24
MS90725-6	96906	53	7	M23053/5-105-0	81349	9	13
MS90725-6	96906	56	18	M23053/5-105-0	81349	25	40
MS90725-6	96906	88	36	M23053/5-105-0	81349	27	81
MS90725-6	96906	92	19	M23053/5-105-0	81349	33	27
MS90725-6	96906	98	1	M23053/5-105-0	81349	33	73
MS90725-6	96906	98	4	M23053/5-105-0	81349	33	80
MS90725-6	96906	98	21	M23053/5-105-0	81349	33	147
MS90725-60	96906	13	101	M23053/5-105-0	81349	33	
MS90725-60	96906	45	9	M23053/5-105-0	81349	35	16
MS90725-60	96906	46	9	M23053/5-106-0	81349	8	41
MS90725-60	96906	48	21	M23053/5-106-0	81349	8	42
MS90725-60	96906	49	14	M23053/5-106-0	81349	9	13
MS90725-60	96906	51	21	M23053/5-106-0	81349	15	23
MS90725-60	96906	78	11	M23053/5-106-0	81349	33	28
MS90725-60	96906	80	1	M23053/5-109-0	81349	1	5
MS90725-62	96906	38	18	M23053/5-109-0	81349	1	9
MS90725-62	96906	38	22	MS3053/5-109-0	81349	1	31
MS90725-64	96906	45	12	M23053/5-109-0	81349	1	41
MS90725-64	96906	46	12	M23053/5-109-0	81349	15	22
MS90725-8	96906	53	13	M23053/5-109-0	81349	94	10
MS90725-80	96906	51	21	M23053/5-109-2	81349	1	3
MS90726-58	96906	97	16	M23053/5-109-2	81349	1	14
MS90726-62	96906	97	54	M23053/5-109-2	81349	1	30
MS90726-90	96906	48	3	M23053/5-109-2	81349	1	40
MS90728-22	96906	41	3	M23053/5-109-2	81349	94	11
MS90728-1	96906	84	12	M2305317-104-C	96906	16	15
MS90728-107	96906	24	18	M24243-1B402	81349	87	
MS90728-14	96906	25	40	M24243-1B402	81349	87	
MS90728-41	96906	42	1	M24243-1B502	81349	87	
MS81528-2P48	96906	8	39	MM24243-1B504	81349	87	
MS91528-2P48	96906	8	49	M24243-1D404	81349	33	138
MS9245-47	96906	59	5	M35206-234	96906	27	54
MS9358-12	96906	59	6	M38510/10201BIC	81349	33	108
M13486-1-12	81349	1	6	M39003-01-3088	81349	33	132
M13486-1-12	81349	1	11	M39003-01-3100	81349	33	96
M13486-1-12	81349	1	16	M39006/02-1240	81349	8	64
M13486-1-12	81349	1	34	M39006/02-1244	81349	7	14
M1450351-282	01295	98	25	M39006/02-272	81349	7	23
M16878-2-20-9	81349	22	97	M39014-01-1340	81349	33	106
M16878-2-20-9	81349	35	18	M39014-02-1356	81349	33	104

TM9-6115-465-24P
 TO 35C2-3-446-4
 NAVFACP-8-625-24P
 SL-4-06858B/06859D

SECTION IV. NATIONAL STOCK NUMBER AND REFERENCE NUMBER INDEX (CONT.)

REFERENCE NO.	MFG. CODE	FIG. NO.	ITEM NO.	REFERENCE NO.	MFG. CODE	FIG. NO.	ITEM NO.
M39022-01-1142	81349	33	125	M5086-2-18-9	81349	33	9
M39022-01-1581	81349	33	114	M5086-2-18-9	81349	33	70
M39022-08-1021	81349	33	85	M5086-2-18-9	81349	33	146
M39022-08-1025	81349	33	88	M5086-2-4-9	81349	18	95
M39022-08-1025	81349	33	91	M5086-2-4-9	81349	20	1
M39022-1-1541	81349	33	118	M5086-2-8-9	81349	84	
M39024-10-02	81349	22	23	M5086-2-8-9	81349	104	
M5080-0-18-9	81349	31	31	M5086-216-9	81349	104	4
M5086-2-4-9	81349	20	3	M5086-2-12-9	81349	27	83
M5086-2-10-9	81349	102	2	M5086-2-12-9	81349	27	84
M5086-2-12-9	81349	10	10	M5086-2-12-9	81349	27	85
M5086-2-12-9	81349	15	7	M5086-2-16-9	96906	16	13
M5086-2-12-9	81349	89	13	M5086-2-18-9	96906	16	9
M5086-2-12-9	81349	94	5	M5089-2-12-9	81349	91	5
M5086-2-12-9	81349	96	7	M5600	74400	8	10
M5086-2-16-9	81349	3	8	M5757-23-003	81349	7	20
M5086-2-16-9	81349	4	7	M5757-23-003	81349	8	71
M5086-2-16-9	81349	9	1	M5757-23-003	81349	27	49
M5086-2-16-9	81349	10	6	M39006A/102-1300	81349	7	14
M5086-2-16-9	81349	11	3	NAS1598-6	80205	22	16
M5086-2-16-9	81349	12	4	NAS549P8	80205	35	9
M5086-2-16-9	81349	15	8	NAS56IC8-22	80205	2	6
M5086-2-16-9	81349	17	3	NLW50-50	14655	22	50
M5086-2-16-9	81349	26	4	NT1138	01843	97	74
M5086-2-16-9	81349	28	3	N110-1	78500	77	8
M5086-2-16-9	81349	29	3	N5001-156	01843	57	41
M5086-2-16-9	81349	30	3	N6	06915	33	57
M5086-2-16-9	81349	32	4	N7	06915	33	60
M5086-2-16-9	81349	34	3	QA18036F15	06840	78	15
M5086-2-16-9	81349	36	2	PUL664	19728	57	34
M5086-2-16-9	81349	89	14	PU602	19728	57	33
M5086-2-16-9	81349	91	4	PX1080	00320	59	3
M5086-2-16-9	81349	93	14	P112	78500	77	39
M5086-2-16-9	81349	94	6	P151211-18	45722	31	16
M5086-2-16-9	81349	95	3	P15121-17	45722	89	3
M5086-2-16-9	81349	96	4	P15121-18	45722	1	26
M5086-2-16-9	81349	99	13	P15121-18	45722	3	2
M5086-2-16-9	81349	99	16	P15121-18	45722	3	11
M5086-2-16-9	81349	99	19	P15121-18	45722	7	5
M5086-2-16-9	81349	99	22	P15121-18	45722	7	7
M5086-2-16-9	81349	99	25	P15121-18	45722	7	16
M5086-2-16-9	81349	99	28	P15121-18	45722	7	21
M5086-2-16-9	81349	101	5	P15121-18	45722	25	22
M5086-2-16-9	81349	103	4	P15121-18	45722	27	16
M5086-2-18-9	81349	9	2	P15121-18	45722	31	16
M5086-2-18-9	81349	25	33	P15121-18	45722	31	20
M5086-2-18-9	81349	25	44	P15121-18	45722	99	32
M5086-2-18-9	81349	31	30	P15121-20	45722	93	35
M5086-2-18-9	81349	31	45	P15121-20	45722	93	46

SECTION IV. NATIONAL STOCK NUMBER AND REFERENCE INDEX (CONT.)

Reference Number	Mfg. Code	Fig. No.	Item No.	Reference Number	Mfg. Code	Fig. No.	Item No.
P15121-3	45722	99	4	QOW343TYPE24- AWG	81349	33	
P15121-3	45722	25	2	RA20TASB103A	81349	23	15
P15121-3	45722	27	45	RA20TASB103A	81349	23	18
P15121-3	45722	4	2	RA30LASB253A	81349	31	6
P15121-3	45722	27	13	RA30TASB102A	81349	23	20
P15121-3	45722	27	15	RA20TASB103A	81349	23	21
P15121-3	45722	27	26	RCR07G100JS	81349	33	120
P15121-3	45722	93	22	RCR07G101JS	81349	33	117
P15121-3	45722	93	48	RCR07G101JS	81349	33	135
P15121-3	45722	98	24	RCR07G101JS	81349	33	136
P15121-32	45722	47	22	RCR07G22JS	81349	33	116
P15121-33	45722	7	33	RCR07G222JS	81349	33	105
P15121-33	45722	25	8	RCR07G333JS	81349	33	99
P15121-33	45722	25	11	RCR07G390JS	81349	33	121
P15121-33	45722	25	13	RCR07G392JS	81349	33	97
P15121-33	45722	31	17	RCR96G463JS	81349	33	95
P15121-33	45722	31	40	RCR07G474JS	81349	33	94
P15121-33	45722	31	42	RCR20G102JS	81349	7	29
P15121-33	45722	35	1	RCR20G222JS	81349	7	27
P15121-34	45722	93	25	RCR20G471JS	81349	33	109
P15121-34	45722	93	30	RLR32C183JM	81349	33	130
P15121-34	45722	93	42	RCR32G102JS	81349	33	128
P15121-35	45722	98	12	RCR32G103JS	81349	33	129
P15121-49	45722	93	39	RCR32G272JS	81349	33	131
P15121-5	45722	4	3	RCR42G151JS	81349	33	124
P15121-50	45722	98	16	RCR42G751JS	81349	33	115
P15121-4	45722	3	1	RER70F294OR	81349	31	24
P15121-64	45722	7	2	RER75F7850R	81349	25	36
P15121-64	45722	13	69	RLR32C1002GR	81394	33	134
P15121-64	45722	21	22	RL2955	81349	13	6
P15121-64	45722	21	26	RL2955	81349	13	13
P15121-64	45722	21	30	RL2955	81349	13	18
P15121-64	45722	21	34	RL2955	81349	13	23
P15121-64	45722	21	42	RL2955	81349	13	31
P15121-64	45722	21	48	RL2955	81349	13	36
P15121-64	45722	25	4	RL2955	81349	13	42
P15121-64	45722	25	6	RL2955	81349	13	48
P15121-64	45722	27	6	RL32S103J	81349	33	134
P15121-64	45722	31	4	RL32S512J	81349	33	130
P15121-64	45722	84	19	RL42S242GTX	81349	33	92
P15121-64	45722	88	27	RL42S12G	81349	33	133
P15121-64	45722	88	30	RNC55K1501FS	81349	33	93
P15121-64	45722	92	23	-RNC55K2002ES	81349	33	103
P15121-64	45722	99	1	RNC55K3242ES	81349	33	102
P15121-78	45722	21	43	RNC55L4991ES	81349	33	100
P15121-84	45722	93	21	RNC55K4992FS	81349	33	110
P383-2	75214	48	20	RPOOZ5-2120GBA	81349	27	8
QQW343DTYPES18AWGW	81348	22	22	RP101UB120KK	81349	27	8
QQW343TYPESSIZE18Z	81349	101		RPC271	81349	6	2
QQW343TYPES16AWG	81348	6					

SECTION IV. NATIONAL STOCK NUMBER AND REFERENCE INDEX (CONT.)

Reference Number	Mfg. Code	Fig. No.	Item No.	Reference Number	Mfg. Code	Fig. No.	Item No.
RPC271TYPE2CLASS68	81348	87	8	WWT700-4DIA375THK036	81348	55	6
RPC271TYPE2CLASS78	81348	27	19	XA744AN	19728	57	27
RWR78S1501FR	81349	27	58	XBN8190	90202	50	12
RWR78S2671FR	81349	22	59	X1516	14740	93	37
RW32V501	81349	22	87	X3416	19728	57	42
RW32V501	81349	27	96	X3433	19728	57	38
RW33V100	81349	27	28	ZZT410A	81348	97	8
RW33V300	81349	33	29	ZZ100550	81348	97	9
RW33V511	81349	33	54	00206	05972	42	6
RW35V100	81349		49	1-126	31211	58	11
RW35V511	81349	33	50	1-130	31211	58	26
RW56V512	81349	27	60	1-171	31211	58	10
RW68V152	81349	8	73	1-1983	95026	97	34
RW68V302	81349	22	66	1-2MMOB	30780	88	10
SA1644-3DOD	78388	62		1-2MROB	30780	92	5
SB1013A	78388	62	8	1-4CR-S	30780	85	23
SCRG112	14655	33	38	1-4MMOS	30780	85	24
SCRG115	14555	33	38	1-4SHP-S	30780	85	25
SP-ZZ-175Z	85814	63	2	1-4CD45S	30780	92	13
SP2201	70411	85	84	1A43KAH1	01411	22	99
SP2201	70411	92	20	1A561	96309	51	33
S1-3502-0137-203	72619	8	47	1G17705	96309	51	53
S8153-6-0310	70210	67	9	1G1771	96309	51	
S9153-6-0310	70210	69	15	1G407	96309	51	
S-915-A	15434	77	36	1G4070	96309	51	32
TAE60-50SBNTN1-FORM	02567	41		1G40704	96309	51	37
TC150-22-4ANSL	85814	75	15	1G40720	96309	51	43
TLF-1213-BJAM	82458	21	18	1G40721	96309	51	42
TLF-3816-SJAM	82458	21	9	1G40723L	96309	51	39
TRA1005	73662	22	43	1G40723R	96309	51	40
TRA1006	73662	22	48	1G4074	96309	51	
TRA1183	73662	22	38	1N4385	81349	35	25
TRA1251	73662	22	43	1P1046	11237	22	19
TRA1252	73662	22	48	1X165	95026	97	80
TRA1266	73662	22	38	1X167	95026	97	61
TW62510	02640	22	63	1X169	96006	97	67
TW62511	02640	22	63	10A500	63743	30	10
TW62514	02640	22	68	10-40736-24	77820	1	44
TW62530	02640	22	62	10127-001	74063	18	34
TXD079-137	98978	22	61	1-127-002	74063	18	35
UC116	29227	22	29	10127-003	74063	18	31
V88-1FA11-80	05574	8	72	101488	73370	49	13
V88-1FA11-80	05574	27	50	101489	73370	48	9
VS448	83003	8	74	101979	73370	63	33
VS448	83003	27	67	1028	73370	51	64
VT285TYPEII-CLASS1	81348	5	13	103326	73370	63	34
WC596/12-4	81348	3	12	103885	24617	83	12
WWP471	81348	83	21				

SECTION IV. NATIONAL STOCK NUMBER AND REFERENCE NUMBER INDEX (CONT.)

REFERENCE NO.	MFG. CODE	FIG. NO.	ITEM NO.	REFERENCE NO.	MFG. CODE	FIG. NO.	ITEM NO.
10394	84760	73	5	11532	84760	69	13
104018	73370	49	3	1155	96309	51	35
104071	73370	49	4	11557A	28265	83	23
104071-72-2015-8	30554	49	3	11582	84760	67	7
10422-1	50603	19	45	11582	84760	68	7
10453	84760	73	14	11582	84760	69	14
10460	89749	63	13	11588	84760	70	2
10464	84760	73	3	11610	84760	70	17
10519	84760	73	13	11662A	28265	76	5
1054	96309	51	44	11683A	28265	83	11
10541	84760	73	12	11813A	28265	83	15
10566GT	31007	77	4	11813A	28265	83	58
10567	84760	73	7	11833A	28265	83	24
10574	84760	73	8	118940	73370	63	36
1064-2	96309	51	45	11919	84760	68	32
107D151F01	19899	42	4	11944A	28265	74	23
107D240G01	19899	38		12-25	31211	58	16
107D274G01	19899	38		12X168	95026	97	60
1075A	28265	83	55	1202F5-4-4	93061	88	24
10819-20	68505	19	17	12040	84760	68	10
10900409	19207	77	9	12040	84760	68	23
11-25	31211	58	18	12054	84760	67	12
11-3	31211	58	8	12106	84760	67	11
11-41	31211	58	17	122F424G01	19899	43	5
11-42	31211	58	7	122F425G01	19899	45	20
11-314	04426	19	69	122F430G01	19899	44	8
11-400	95026	97	33	122F431F01	19899	46	22
11X147	95026	97	49	12216	84760	72	20
1107A	96309	51	54	12221	84760	68	26
11076	84760	72	17	12237	84760	68	9
11141	84760	72	14	12259	84760	73	2
11175	84760	72	12	12288	84760	70	1
11196	84760	72	13	12293A	28265	83	25
11208	84760	72	24	12360	84760	68	28
11212	84760	72	25	12362	84760	68	29
1126A	18165	77	22	12406	84760	69	3
11304	84760	72	11	12480	84760	67	20
11329	84760	69	19	125-7047	95026	97	83
11331	84760	73	9	1250041G01	19899	42	3
11346	84760	72	22	1250047G01	19899	45	8
11437	84760	72	19	125C124F01	19899	39	7
11438	84760	72	18	125C127F01	19899	38	17
11439	84760	72	21	125C129G02	19899	45	
11470	12670	25	9	125C131F01	19899	40	4
11486	12670	25	12	125C204G01	19899	42	
11507	84760	64	6	125C209G01	19899	40	
11507	84760	71	18	125C213G01	19899	39	
11508	84760	69	8	125C258G01	19899	43	4
11525	84760	69	18	125C260F01	19899	45	23

SECTION IV. NATIONAL STOCK NUMBER AND REFERENCE NUMBER INDEX (CONT.)

REFERENCE NO.	MFG. CODE	FIG. NO.	ITEM NO.	REFERENCE NO.	MFG. CODE	FIG. NO.	ITEM NO.
125C262G01	19899	45	21	1399	84760	51	50
125C263G01	19899	45		14-1000	95026	97	25
125C267F01	19899	41		14207	31211	58	19
125C270G01	19899	41		14-208	31211	58	35
125C273F01	19899	46	25	14-209	31211	58	33
125C306G01	19899	46	2	14-46	31211	58	6
125C311G01	19899	44		14-801	95026	97	30
125C324G01	19899	46		1423	96309	51	41
12500	84760	67	16	14259	84760	71	4
12513	84760	67	17	143A832F01	19899	39	2
12622	84760	71	9	143A870F01	19899	40	1
12627A	28265	65	7	143A913F01	19899	40	3
12640	84760	71	1	143A929F04	19899	45	23
12741	84760	71	5	143A929F06	19899	46	24
12743	84760	71	6	143A930F01	19899	45	17
12745	84760	71	7	143A930F01	19899	46	17
12764	84760	71	3	143A933F01	19899	39	3
12765	84760	71	14	143A941F01	19899	46	18
12766	84760	71	15	143768	73370	63	26
1279574	80064	63	35	143863	73370	63	32
12949	84760	71	16	14408	84760	68	11
1290497	80064	18	46	14408	84760	68	24
12957	84760	68	15	14483	84760	72	2
12966	84760	69	11	14512A	28265	80	23
12966	84760	70	12	14613	62429	21	40
12972	84760	68	2	14615	62429	21	29
12972	84760	68	21	14616	62429	21	29
12979	84760	68	8	14680	84760	70	16
12988	84760	68	6	14728A	28265	77	24
13003	84760	68	14	14733	84760	71	8
13010	84760	68	13	14801	96309	51	46
13114A	28265	76	10	14803	96309	51	55
13132A	28265	77	10	14875A	28265	78	14
13331A	28265	83	56	14895-001	74063	18	62
13337A	28265	65	2	1490	96309	51	45
13550	84760	70	15	1490	96309	51	52
13554	84760	70	4	14907A	28265	83	22
13-5	31211	58	9	1491A	28265	65	18
13558	84760	70	6	1491A	28265	65	21
13567	84760	70	11	1491A	28265	65	24
13616	96309	51	51	1491A	28265	65	29
13622	96309	51	35	14966	84760	68	1
13623B	96309	51	36	15-1001	95026	97	19
13672	84760	70	14	15-255	31211	58	24
13814A	28265	83	32	15-26	31211	58	47
13825	84760	72	29	15-27	31211	58	12
13837	84760	72	26	15-3	31211	58	14
13839	84760	72	28	15-39	31211	58	29
1390	84760	51	38	15-51	31211	58	30

SECTION IV. NATIONAL STOCK NUMBER AND REFERENCE INDEX (CONT.)

Reference Number	Mfg. Code	Fig. No.	Item No.	Reference Number	Mfg. Code	Fig. No.	Item No.
15-67	31211	58	48	1588145F01	19899	38	7
15-7	31211	58	51	1588147F01	19899	39	6
15-806	95026	97	13	1588149F01	19899	38	10
15-901-1	95026	97	18	1588161F01	19899	41	4
15-901-2	95026	97	17	1588166F01	19899	42	3
150-36176	64294	59	23	1588166F01	19899	44	3
150015	73370	63	38	1588199F01	19899	44	6
15037-006	74063	18	14	1588243F01	19899	39	5
151-36154	64294	59	24	1588386G01	19899	43	
151-36154	64294	59	33	1588887G01	19899	45	20
151-36155-7	64294	59	34	1588887G01	19899	46	21
151-36159	64294	59	20	1588442G01	19899	46	23
151-36162	64294	59	22	1588453G01	19899	44	
151-36164-2	64294	59	29	1588468F01	19899	41	6
151-36175-1	64294	59	25	15765	85760	69	17
151-36179	64294	59	32	15877	84760	69	16
151-37606-1	64294	59	17	1598079	19899	38	13
151-38029	64294	59	14	15913	84760	69	7
151-39536	64294	59	10	16-004-013	43990	93	12
151-39538	64294	59	13	16-125	31211	58	34
151-41463	64294	59	30	16-126	31211	58	22
151-41464	64294	59	18	16-80	31211	58	39
151-41465	64294	59	11	16-806	95026	97	41
151392	73370	63	28	16-81	31211	58	41
151424	73370	63	29	16-82	31211	58	40
151728	73370	63	31	16-93	31211	58	42
152-36156-18	64294	59	31	16-98	31211	58	52
152-40008-1	64294	59	28	16TU1710	95026	97	14
152-64172-6	64294	59	27	16054-001	74063	18	2
152068	73370	63	30	1618624	19899	38	25
15225	84760	69	4	16135	84760	68	19
15228	84760	69	1	16136	84760	68	17
15438	84760	71	16	16144	84760	73	11
154746	73370	63	27	16225	84760	72	23
1550288	28265	81	24	16243	84760	71	13
15627	84760	69	5	16278	84760	67	19
1569A	28265	81	14	16355	84760	67	18
15699	84760	69	21	16369	84760	83	
15750	84760	71	12	16395	84760	73	1
1588016G01	19899	39	8	16396	84760	67	21
1588124F01	19899	40	6	16440	84760	72	20
158814201	19899	45	13	16558	84760	70	8
1588142F01	19899	46	13	16572	84760	70	9
1588142G02	19899	45	14	18575	84760	70	19
1588142G02	19899	46	14	16576	84760	70	20
1588142F03	19899	45	10	16579	84760	70	23
1588142F03	19899	46	10	16580	84760	70	24
1588142F04	19899	45	11	16581	84760	70	25
1588142F04	19899	46	11	16582	84760	70	26

SECTION IV. NATIONAL STOCK NUMBER AND REFERENCE INDEX (CONT.)

Reference Number	Mfg. Code	Fig. No.	Item No.	Reference Number	Mfg. Code	Fig. No.	Item No.
16583	84760	70	27	20-150	31211	58	5
16587	84760	70	25	20-156	31211	58	45
17-135	95026	97	24	20-160	31211	58	28
17-136	95026	97	23	20-223	31211	58	25
17-137	95026	97	27	20-234	31211	58	53
17-138	95026	97	26	20-320	31211	58	46
17056	84760	69	2	20-34	31211	58	36
172-314S5P2	29578	55		20-4	31211	57	31
17451	84760	69	10	20-5	31211	57	32
17513	84760	72	9	20-7	31211	57	37
17604	84760	68	31	20-7	31211	58	13
17619	84760	68	20	20-92	31211	58	15
1798078	36024	38	14	20-93	31211	58	50
17981	84760	73	16	200087A	28265	48	34
18-400	95026	97	42	20087A	28265	49	17
18275	84760	70	5	20113	84760	71	2
18501	84760	67	15	20117	84760	72	15
1865A	28265	79	8	201400A	28265	63	22
1865A	28265	80	3	201426A	28265	76	6
18657	84760	69	20	20154	84760	67	10
18658	84760	69	22	201565	28265	80	6
187C704P433	89954	7		201914A	28265	63	21
18770	84760	72	16	201941	00736	77	1
18785	84760	72	10	201991A	28265	82	4
18948	84760	73	10	202138A	28265	63	24
18967	84760	71	11	20214	84760	72	1
18968	84760	71	10	20219	84760	70	7
18986	84760	72	8	20222	84760	72	3
19-900	85026	97	48	20223	84760	70	13
1945630	16764	64		20224	84760	70	3
2-522	85026	97	50	20225	84760	68	30
2-8	31211	58	38	20226	84760	68	27
2-9	31211	58	37	20227	84760	72	7
2-096	95026	97	21	20235	84760	72	6
2A9178102	04178	98	22	20237	84760	72	5
2DA1250	11502	22	95	20238	84760	73	15
2N1596	80131	7	27	-02436A	28265	78	13
2N3773	80131	22	56	202568A	28265	81	13
2P1181	11237	22	17	202854A	28265	75	4
2W1 -24-24-92	43999	67	4	202996A	28265	74	4
20-102	31211	58	21	203077A	28265	77	25
20-109	31211	58	49	203329AS	28265	83	35
20-111	31211	58	31	203349A	28265	83	59
20-113	31211	58	27	203480A	28265	77	11
20-120	31211	58	44	203924A	28265	75	7
20-121	31211	57	15	203986B	28265	83	30
20-121	31211	58	32	204236A	28265	74	6
20-136	31211	58	1	204420A	28265	77	2
20-137	31211	58	2	204429A	28265	74	1
20-143	31211	58	23				

SECTION IV. NATIONAL STOCK NUMBER AND REFERENCE INDEX (CONT.)

Reference Number	Mfg. Code	Fig. No.	Item No.	Reference Number	Mfg. Code	Fig. No.	Item No.
204509B	28265	83	44	255013	28265	77	42
204591 B	28265	83	28	255023A	28265	77	28
20460LA	28265	83	33	255072A	28265	82	5
204607A	84760	69	12	255073B	28265	82	7
20475	84760	70	10	255080A	28265	77	14
2050	71177	84	45	255161A	28265	83	37
205317A	28265	83	16	2551798B	28265	78	9
205351A	28265	83	49	255185A	28265	78	6
205354A	28265	77	32	255360A	28265	74	16
206-2838S	28265	63	4	255361B	28265	74	23
206024A	28265	83		255365A	28265	74	8
206278A	28265	63	13	255368CS	28265	83	
206378A	28265	83	13	255369D	28265	74	27
206425A	28265	77	23	255370C	28265	74	21
206728A	28265	63	13	255371B	28265	74	22
206752	28265	66	14	255510A	28265	82	1
206752A	28265	77	34	255561 A	28265	83	4
206802-A	28265	79	4	255761 A	28265	83	8
206880A	28265	75	12	255772A	28265	61	15
20849	84760	70	18	255772A	28265	83	9
209P8-4	93061	93	11	256019B	28265	83	34
2181003-2	81073	98	17	2562900DS	28265	74	
2138101	12670	25	10	256581A	28265	74	22
215PN4	30780	88	23	2600460	28265	80	9
215PN8	20780	88	9	260047B	28265	80	13
206PS	30780	88	8	260269B	28265	78	1
2175-12650	28265	61	19	260935	65092	8	15
2189A	28265	83	43	2642-24850N140	06540	93	26
22-3009	92857	51	27	2661-20395N152	06540	93	36
22-407	95026	97	32	266701A	28265	75	9
2268917-2L03G	62494	59		266701A	28265	75	19
2210A	28265	80	29	267A	28265	79	1
22238	84760	71	17	267838	65092	8	13
224-6	93061	86	6	267839	65092	8	14
2359A	28265	74	1	267840	65092	8	13
240068	50999	47	2	267841	65092	8	14
240091	50999	47	14	267843	65092	8	16
240096	50999	47	3	268086	65092	8	30
2411A	28265	80	15	268087	65092	8	30
24902	96309	51	65	268420	64092	8	
2403LW	82121	99	30	268421	65094	8	
2492	96309	51		27X465C	95026	97	77
25-7046	95026	97	73	27289-001	74063	18	88
252-39535	64204	59	16	27873-001	74063	18	68
253633	65092	8	9	28A	28265	61	12
2538	80672	2	11	28A	28265	78	7
254013	30554	8	17	28A	28265	83	6
254014	65092	8	16	28204	96309	51	49
255012A	28265	77	43				

SECTION IV. NATIONAL STOCK NUMBER AND REFERENCE INDEX (CONT.)

Reference Number	Mfg. Code	Fig. No.	Item No.	Reference Number	Mfg. Code	Fig. No.	Item No.
28316-001	74063	18	30	288290AS	28265	81	
28419-D02	74063	18	33	288291AS	28265	81	
285111B	28265	83	53	288704-00	28265	75	3
285123C	28266	83	50	288795A	28265	59	4
285129B	28265	83	51	288750C	28265	75	7
285184B	28265	78	16	28996-010	74063	18	60
285194A	28265	78	20	29014-010	74063	18	61
285196B	28265	78	10	2903300	28265	76	8
285203F	28265	77	6	290515-AS	28265	65	20
285213	28265	77	7	290516AS	28265	65	23
285271A	28265	78	30	290577A	28265	65	19
285718C	28265	74	9	290577AS	28265	65	17
286013B	28265	83	41	290662AS	28265	65	16
286116A	28265	81	7	290663AS	28265	65	28
286269B	28265	78	21	290679D	28265	76	3
286303D	28265	78	24	290697A	28265	65	22
28676-001	74063	18	15	290698A	28265	65	25
28678-001	74063	18	9	2907770	28265	73	25
28683-001	74063	18	48	2910108	28265	77	32
287012A	28265	77	27	2910350	28265	79	12
287060	28265	82	7	2910350	28265	80	30
287218	28265	77	41	291159A	28265	81	8
28267B	28265	81	17	291160AS	28265	81	
287268A	28265	81	19	291161B	28265	81	10
287269A	28265	81	18	291162B	28265	81	11
28270BS	28265	81	15	291163B	28265	81	12
287311DS	28265	78	18	291984	28265	78	5
287313A	28265	78	23	291608-A	28265	66	11
287414A	28265	78	19	291656A	28265	65	30
287315AS	28265	78	22	29233-001	74063	18	51
28744-001	74063	18	25	2930118	28265	79	30
28791-001	74063	18	49	293200B	28265	77	40
288020A	28265	77	30	293205-AS	28265	77	
288021A	28265	77	29	293516A	27255	67	35
288025AS	28265	76		29539055	54284	59	21
288026AS	28265	81	26	29569-23	64294	59	19
288075A	28265	77	17	295901-2	96530	8	5
288077BS	28265	77	15	29602-6	64294	59	12
288095AS	28265	81	5	29629-10	64294	59	9
288100C	28265	83	46	296791-011	64294	59	26
288101C	28265	83	47	29691-906	64294	59	15
288103C	28265	83	48	29900-010	74063	18	58
288104B	28265	83	52	29901-010	74063	18	59
288105A	28265	83	45	3-1205	95026	97	44
288106AS	28265	83		3-15	31211	58	20
288187D	28265	81	4	3-4SHPS	30780	84	
288198B	28265	81	2	3-410	95026	97	46
288199A	28265	81	3	3-5	31211	58	43
288263C	28265	78	17	3-800458	30780	92	8

SECTION IV. NATIONAL STOCK NUMBER AND REFERENCE NUMBER INDEX (CONT.)

REFERENCE NO.	MFG. CODE	FIG. NO.	ITEM NO.	REFERENCE NO.	MFG. CODE	FIG. NO.	ITEM NO.
3-800458	45681	88	7	30554-70-1466	36024	93	38
3-8MMO	45681	63	15	30554-70-1531-1	36024	50	40
3-907	95026	97	39	30554-70-1531-1	36024	97	7
30274-002	74063	18	83	30554-70-502	36024	13	75
30392-001	74063	18	13	30554-70-507	36024	48	48
30393-5	14655	33	37	30554-70-507-1	36024	48	17
30393-9	14655	33	37	30554-70-507-12	36024	48	15
30396-010	74063	18	91	30554-70-507-15	36024	48	12
30413-010	74063	18	24	30554-70-507-3	36024	49	5
30469-020	74063	18	43	30554-70-507-5	36024	48	6
305A	28265	74	7	30554-70-507-5	36024	49	7
30554-69-530	36024	7		30554-70-507-9	36024	48	13
30554-69-532	36024	7	15	30554-70-507-12-1	36024	48	15
30554-69-533	36024	7	17	30554-70-514	36024	7	36
30554-69-536	36024	7	6	30554-71-2264	36024	31	21
30554-69-539-2	36024	85	26	30554-72-1531-2	36024	50	30
30554-69-541	36024	7	32	30554-72-2001	36024	84	46
30554-69-545	36024	7	35	30554-72-2004	36024	57	14
30554-69-561-6	36024	33	5	30554-72-2007	36024	51	10
30554-69-580	36024	5	3	30554-72-2008	36024	50	11
30554-69-581	36024	5	7	30554-72-2009	36024	13	98
30554-69-582	36024	5	9	30554-72-2010	36024	50	33
30554-69-583	36024	5	6	30554-72-2011	36024	50	43
30554-69-590-1	36024	8		30554-72-2012	36024	50	23
30554-69-590-2	36024	8		30554-72-2013	36024	50	18
30554-69-591	36024	3	78	30554-72-2014	36024	50	17
30554-69-592	36024	8	78	30554-72-2015	36024	51	
30554-69-650	36024	89		30554-72-2018	36024	51	11
30554-69-654	36024	89	4	30554-72-2019	36024	24	10
30554-69-655	36024	89	20	30554-72-2021	36024	57	6
30554-69-656	36024	89	15	30554-72-2024	36024	84	27
30554-69-677	36024	9		30554-72-2028	36024	84	26
30554-69-692-6	36024	84	39	30554-72-2031	36024	1	24
30554-69-698	36024	55	6	30554-72-2032	36024	84	17
30554-69-764	36024	8	75	30554-72-2033	36024	56	7
30554-69-765	36024	8	64	30554-72-2035	36024	13	71
30554-69-767	36024	27	61	30554-72-2035	36024	84	34
30554-69-768	36024	27	46	30554-72-2038	36024	13	112
30554-69-722-2	36024	87		30554-72-2039	36024	37	25
30554-70-1172	36024	21	32	30554-72-2040	36024	37	20
30554-70-1229	36024	93	5	30554-72-2041	36024	37	12
30554-70-1230	36024	93	44	30554-72-2045	36024	13	92
30554-70-1231	36024	93	43	30554-72-2046	36024	13	87
30554-70-1232	36024	93		30554-72-2047	36024	84	17
30554-70-1233	36024	93	49	30554-72-2049	36024	13	69
30554-70-1282	36024	93	27	30554-72-2051	36024	2	5
30554-70-1283	36024	93	28	30554-72-2052	36024	59	8
30554-70-1284	36024	93	33	30554-72-2053	36024	2	7
30554-70-1416	36024	92	32	30554-72-2055	36024	51	14

SECTION IV. NATIONAL STOCK NUMBER AND REFERENCE NUMBER INDEX (CONT.)

REFERENCE NO.	MFG. CODE	FIG. NO.	ITEM NO.	REFERENCE NO.	MFG. CODE	FIG. NO.	ITEM NO.
30554-72-2056	36024	51	12	30554-72-2134	36024	13	22
30554-72-2057	36024	2	12	30554-72-2136	36024	84	44
30554-72-2058	36024	21	33	30554-72-2137	36024	2	10
30554-72-2059	36024	21	39	30554-72-2138	36024	13	7
30554-72-2063	36024	22	10	30554-72-2138	36024	13	32
30554-72-2065	36024	13	61	30554-72-2138	36024	13	37
30554-72-2067-1	36024	1	20	30554-72-2138	36024	13	43
30554-72-2067-2	36024	22	3	30554-72-2138	36024	13	49
30554-72-2068	36024	22	9	30554-72-2142	36024	13	27
30554-72-2070	36024	13	11	30554-72-2144	36024	21	14
30554-72-2071	36024	13	41	30554-72-2145	36024	21	3
30554-72-2072	36024	13	47	30554-72-2146	36024	86	16
30554-72-2073	36024	13	35	30554-72-2151	36024	85	8
30554-72-2079	36024	13	5	30554-72-2153	36024	85	11
30554-72-2080	36024	13	65	30554-72-2163	36024	85	4
30554-72-2083	36024	84	14	30554-72-2164	36024	67	1
30554-72-2090	36024	1	19	30554-72-2166	36024	74	17
30554-72-2091	36024	24	4	30554-72-2176	36024	13	6
30554-72-2095	36024	13	103	30554-72-2202	36024	51	7
30554-72-2096	36024	13	108	30554-72-2204	36024	27	36
30554-72-2098-1	36024	21	4	30554-72-2210	36024	25	5
30554-72-2098-2	36024	21	16	30554-72-2210	36024	31	5
30554-72-2098-3	36024	21	15	30554-72-2211	36024	25	25
30554-72-2099-1	36024	37	4	30554-72-2213	36024	21	7
30554-72-2100	36024	49	21	30554-72-2214	36024	21	11
30554-72-2101	36024	52	3	30554-72-2215-2	36024	21	21
30554-72-2102	36024	52	6	30554-72-2219	36024	59	7
30554-72-2105	36024	13	83	30554-72-2220	36024	31	
30554-72-2106	36024	13	79	30554-72-2221-2	36024	21	17
30554-72-2108	36024	13	17	30554-72-2244	36024	26	
30554-72-2109	36024	53	66	30554-72-2225-2	36024		
30554-72-2110-1	36024	86	2	30554-72-2226	36024	25	28
30554-72-2110-2	36024	86	4	30554-72-2227	36024	25	37
30554-72-2110-4	36024	86	3	30554-72-2228	36024	31	
30554-72-2110-5	36024	51	18	30554-72-2232	36024	27	
30554-72-2110-6	36024	51	16	30554-72-2233	36024	27	5
30554-72-2111	36024	84	31	30554-72-2234	36024	36	
30554-72-2112	36024	56	19	30554-72-2235	36024	27	43
30554-72-2115	36024	87	9	30554-72-2236	36024	21	10
30554-72-2117	36024	24	11	30554-72-2237	36024	21	5
30554-72-2118	36024	14	1	30554-72-2238	36024	28	
30554-72-2119	36024	85	18	30554-72-2239	36024	27	
30554-72-2120	36024	55	5	30554-72-2241	36024	26	14
30554-72-2122	36024	86	7	30554-72-2243	36024	25	
30554-72-2123	36024	86	14	30554-72-2244	36024	31	44
30554-72-2125	36024	86	15	30554-72-2245	36024	32	
30554-72-2126	36024	86	8	30554-72-2247	36024	11	
30554-72-2128	36024	84	3	30554-72-2248	36024	11	
30554-72-2132	36024	56	5	30554-72-2253	36024	31	

SECTION IV. NATIONAL STOCK NUMBER AND REFERENCE NUMBER INDEX (CONT.)

REFERENCE NO.	MFG. CODE	FIG. NO.	ITEM NO.	REFERENCE NO.	MFG. CODE	FIG. NO.	ITEM NO.
30554-72-2259	36024	10		30554-72-2843	36024	92	25
30554-72-2260	36024	31		30554-72-2849	36024	92	30
30554-72-2265	36024	21	30	30554-72-2855	36024	95	
30554-72-2266	36024	31	44	30554-72-2856	36024	91	
30554-72-2271	36024	84	20	30554-72-2857	36024	92	21
30554-72-2274	36024	3		30554-72-2860	36024	92	34
30554-72-2275	36024	3	14	30554-72-2861	36024	92	33
30554-72-2276	36024	3	16	30554-72-2866	36024	98	6
30554-72-2280	36024	1	39	30554-72-2868-1	36024	99	17
30554-72-2281-1	36024	1	1	30554-72-2868-2	36024	99	20
30554-72-2281-2	36024	1	7	30554-72-2868-3	36024	99	11
30554-72-2281-3	36024	1	12	30554-72-2868-4	36024	99	14
30554-72-2282	36024	17		30554-72-2868-5	36024	99	26
30554-72-2284	36024	15		30554-72-2868-6	36024	99	23
30554-72-2286	36024	4		30554-72-2871	36024	103	
30554-72-2288	36024	34		30554-72-2872	36024	102	
30554-72-2290-2	36024	18		30554-72-2874	36024	98	
30554-72-2291-2	36024	1	25	30554-72-2875	36024	96	
30554-72-2299	36024	47	12	30554-72-2907	36024	87	
30554-72-2390	36024	84		30554-72-2908	36024	87	
30554-72-2391	36024	84		30554-72-2909	36024	87	
30554-72-2459-4	36024	38	25	30554-72-2910	36024	87	
30554-72-2600	36024	33		30554-72-2911	36024	87	
30554-72-2601	36024	33		30554-72-2914	36024	87	
30554-72-2602	36024	33	139	30554-72-2915	36024	87	
30554-72-2604	36024	33	74	30554-72-2916	36024	87	
30554-72-2605	36024	33	4	30554-72-2920	36024	87	
30554-72-2606	36024	33	8	30554-72-2925	36024	87	
30554-72-2610	36024	33	140	30554-72-2926	36024	87	
30554-72-2611	36024	33	76	30554-72-2928	36024	87	
30554-72-2616	36024	33	76	30554-72-2929	36024	87	
30554-72-2620	36024	33	16	30554-72-515	36024	7	34
30554-72-2621	36024	33	15	30590-010	74063	18	36
30554-72-2622	36024	33	82	30592-010	74063	18	28
30554-72-2627	36024	33	143	30595-010	74063	18	90
30554-72-2628	36024	33	63	30596-020	74063	18	75
30554-72-2800	36024	99	36	30651-010	74063	18	47
30554-72-2803	36024	99	2	30707-001	74063	18	74
30554-72-2808	36024	99		30720-001	74063	18	50
30554-72-2812	36024	98	18	30789-010	74063	18	89
30554-72-2821	36024	99	33	30825-001	74063	18	32
30554-72-2822	36024	107		30918-010	74063	18	87
30554-72-2823	36024	106		30920-020	74063	18	16
30554-72-2825	36024	105		30921-010	74063	18	69
30554-72-2828	36024	104		314384-200	67049	51	27
30554-72-2829	36024	100		315-175-02	08599	92	27
30554-72-2832	36024	99	9	315A	28265	75	16
30554-72-2836	36024	92		315A	28265	80	2
30554-72-2839	36024	97	2	315A	28265	80	11

SECTION IV. NATIONAL STOCK NUMBER AND REFERENCE NUMBER INDEX (CONT.)

REFERENCE NO.	MFG. CODE	FIG. NO.	ITEM NO.	REFERENCE NO.	MFG. CODE	FIG. NO.	ITEM NO.
316A	28265	83	10	40-0000146	28265	83	36
31827-001	74063	18	73	40-0000706A	28265	81	6
31877-010	74063	18	80	40-0001314A	28265	79	2
31904LT	83121	8	20	40-001517A	28265	80	19
3200X6	79470	63	14	40-0001525	28265	77	5
32003-010	74063	18	42	40-0001617B	28265	83	31
3204A	28265	75	14	40-0001618B	29265	83	27
32059A	28265	83	3	40-000-1619	28265	83	27
32187-001	74063	18	20	40-0001720A	28265	77	3
3220X6X4	79470	51	20	40-0002727A	28265	85	14
32223-010	74063	18	17	40-0003205	28265	79	11
3225-001	74063	18	3	40-0003216A	28265	80	10
3235A	28265	63	19	40-0003640D	28265	48	23
33X203	95026	97	72	40-0003640D	28265	49	16
3306A	28265	76	7	40-0003820A	28265	77	13
335A	29265	67	3	40-0003821A	28265	77	19
342A	28265	74	14	40-0003828	28265	61	14
3456W36-7P	96906	30	2	40-0005529A	28265	85	37
35070	73370	48	14	40-0007109A	28265	65	5
3600X2	79470	65	33	40-0007109A	28265	65	7
3673A	28265	80	28	40-0009501A	28256	65	6
369B106G01	19899	33	29	40-0011155	28265	83	35
369B208G01	19899	33	29	40-0011906C	28265	83	42
369B209G01	19899	33	41	40-0012306B	28265	80	21
369B210G01	19899	33	22	40-0017301B	28265	77	16
37TB10	81349	25	16	40-0018601A	28265	61	17
37TB4	81349	25	31	40-001865A	28265	61	16
37TB6	81349	31	34	40-2076001	28265	80	22
37TB8	81349	31	38	40-3001-704E	28265	83	60
37TB8	81349	33	19	40-3001-755B	28265	83	
3734A	28265	65	31	40-3003058	28265	81	
375045A	28265	61	18	40-3005101	28265	77	20
38T820	81349	27	32	40-3005201A	28265	77	18
383	96309	51	56	40-3005202C	28265	77	12
39TB2	81349	21	52	40-3015101C	28265	80	27
39TB10	81349	8	61	40-3015152C	28265	80	25
3903	96309	51	57	40-3015801D	28265	80	8
3906	96309	51	58	40-3019151D	28265	78	4
3910	96309	51	62	40-3025151	28265	78	
3911	96309	51	63	40-3035051DS	28265	74	
3912	96309	51	60	40-3040801D	28265	79	10
3913	96309	51	59	40-30453-1C	28265	79	3
3914	96309	51	61	40-3044152C	28265	66	
39187BS	28265	74	26	40-3055102A	28265	66	13
4S6-74D	86577	33	126	40-3070101B	28265	75	18
4-1205	95026	97	45	40-3070401	28265	75	10
4-410	95206	97	38	40-3075901	28265	80	17
4-907	95026	97	40	40-3076051	28265	80	20
40-0000104A	28265	83	17	40-3076101C	28265	83	2

SECTION IV. NATIONAL STOCK NUMBER AND REFERENCE INDEX (CONT.)

Reference Number	Mfg. Code	Fig. No.	Item No.	Reference Number	Mfg. Code	Fig. No.	Item No.
40-30764010	28265	81	24	49X3	79470	65	26
40-3076401D	28265	80	17	4920-87	02032	48	18
40-3080201C	28265	74	19	4920-87	02032	49	11
40-3092304	28265	78	27	4920-89	02032	48	19
40-3092305A	28265	78	26	4920-89	02032	49	12
40-3092309A	28265	78	28	5-40TXS	45681	85	22
40-3092354B	28265	78	29	5-405XS	08762	93	20
40-3092356B	28265	78		500TXS	30780	88	24
40-3092409	28265	81	35	50035613	11757	80	24
40-3092754A	28265	65	2	5LHBTXS	45681	87	7
40-3093301A	28265	81	1	5X101	95026	97	59
40-3094661A	28265	83		50OGM	66295	75	2
40-3094662A	28265	77	41	501	79550	1	4
40-3094662A	28265	81		50301-049	74063	18	64
40-3095702A	28265	80	26	50406-031	74063	18	76
40-3097001	28265	65	10	50408-081	74063	18	44
40-3097002	28265	65	11	50408-081	74063	18	81
40-3097003	28265	65	12	50410-031	74063	18	26
40-3097004	28265	65	13	50410-031	74063	18	70
40-3097005	28265	65	14	505AS	57733	8	6
40-3097006	28265	65	15	505AC	57733	8	8
40-30971001C	28265	81	23	505BE	57733	8	7
40-450B	95026	97	84	506	79550	1	10
40TB12	81349	27	45	506	79550	1	13
40065A	28265	82	8	506-AL	57733	63	1
4020-6	95026	97	51	50900-111	74063	18	29
403-10	95026	87	37	51X3	72470	65	27
403-11	95026	97	36	5100-011-099	82415	92	31
4039A	28265	59	2	5100-11-198	82415	88	13
415A	28265	75	13	511-041800-00	78189	25	34
415A	28265	83	57	511-041800-00	78189	33	61
4151A	28265	83	26	511-041800-00	78189	33	141
42T86	81349	8	69	511-041800-00	78189	89	16
422A031	18310	22	76	511-041800-00	78189	93	47
4304A	28265	77	21	511-041800-00	78189	93	5
433747	47733	84	21	511-061800-00	48189	93	20
4364A	28265	84	6	511-061800-00	78189	93	22
440035	91265	48	9	511-061800-00	78189	3	4
440035	91265	63	35	511-061800-00	78189	8	76
444783	19206	77	37	511-061800-00	78189	25	14
4585A	28265	78	2	511-061800-00	78189	25	26
4585A	28265	83	38	511-061800-00	78189	25	29
4728A	28265	66	1	511-061800-00	78189	27	9
47901-2900-201	72619	8	18	511-061800-00	78189	27	30
479135	72850	50	8	511-061800-00	78189	27	44
479136	70850	50	7	511-061800-00	78189	27	52
479136	70850	50	7	511-061800-00	78189	31	22
48X3	79740	65	32	511-061800-00	78189	31	36
48X6	76849	83	19	511-061800-00	78189	33	17
48684	28265	74	12				

SECTION IV. NATIONAL STOCK NUMBER AND REFERENCE INDEX (CONT.)

Reference Number	Mfg. Code	Fig. No.	Item No.	Reference Number	Mfg. Code	Fig. No.	Item No.
511-061800-00	78189	33	77	51701-301	74063	18	67
511-061800-00	78189	33	83	51702-121	74063	18	23
511-061800-00	78189	33	86	51702-121	74063	18	56
511-061800-00	78189	33	89	51702-151	74063	18	78
511-061800-00	78189	93	34	51702-431	74063	18	12
511-061800-00	78189	93	45	51802-011	74063	18	63
511-061800-00	78189	8	21	51804-011	74063	18	66
511-061800-00	78189	5	5	51804-021	74063	18	53
511-061800-00	78189	8	11	51804-021	74063	18	55
511-061800-00	78189	8	28	51806-031	74063	18	77
511-061800-00	78189	8	34	51808-011	74063	18	82
511-061800-00	78189	8	37	51808-021	74063	18	41
511-061800-00	78189	8	59	51808-021	74063	18	45
511-061800-00	78189	25	18	51810-011	74063	18	27
511-061800-00	78189	27	34	51810-011	74063	18	71
511-061800-00	78189	31	32	51810-031	74063	18	85
511-061800-00	78189	33	20	52001-006	74063	18	57
511-061800-00	78189	33	39	5211	74545	3	6
511-061800-00	78189	33	55	5330-295	55070	66	3
511-061800-00	78189	33	58	5339-334	U0041	66	6
511-061800-00	78189	65	34	53601-036	74063	18	
511-061800-00	78189	8	31	53601-043	74063	18	
511-061800-00	78189	8	63	57400-016	74063	18	19
511-061800-00	78189	8	66	59A	28265	83	14
511-061800-00	78189	31	8	6-CYX-S	30780	55	24
511-061800-00	78189	93	39	6-6CTX	30780	55	19
511-061800-00	78189	97	19	6S56-30V	08805	8	19
511-061800-00	78189	31	8	630	79470	47	17
511-061800-00	78189	33	13	600J	74282	25	17
511-061800-00	78189	22	25	600J	75382	31	39
511-061800-00	78189	33	35	6000	44655	22	85
511-061800-00	78189	33	42	6007	44655	22	93
511-061800-00	78189	33	44	601J	75382	27	33
511-061800-00	78189	33	51	602J	75382	8	62
511-061800w	78189	33	25	606	95026	97	28
511-061800-00	78189	33	23	6123	44655	33	48
511-061800-00	78189	98	20	615A	28265	61	13
51204-231	74063	18	65	615A	28265	74	2
51204-391	74063	18	6	615A	28265	74	5
51204-541	74063	18	18	615A	28265	78	8
51204-541	74063	24	48	615A	28265	83	7
51204-781	74063	18	54	6161738	28265	78	25
51204-831	74063	18	21	620A	28265	83	54
51204-251	74063	18	79	6307-2RS	52676	40	5
51208-061	74063	18	4	630428S	32377	93	5
51208-211	74063	18	40	64-2	59730	14	3
51208-011	74063	18	10	6560	79470	51	19
51210-271	74063	18	84	68240	31356	93	6
51410-002	74063	18	72	69-502-2	30554	35	15
51701-291	74063	18	8				

SECTION IV. NATIONAL STOCK NUMBER AND REFERENCE NUMBER INDEX (CONT.)

REFERENCE NO.	MFG. CODE	FIG. NO.	ITEM NO.	REFERENCE NO.	MFG. CODE	FIG. NO.	ITEM NO.
69-502-3	30554	22	105	69-561-2	30554	33	77
69-502-4	30554	22	106	69-561-2	30554	33	83
69-502-5	30554	22	107	69-561-2	30554	33	83
69-502-5	30554	22	107	69-561-2	30554	33	83
69-502-5	30554	33	66	69-561-2	30554	33	86
69-502-6	30554	22	108	69-561-2	30554	33	89
69-502-7	30554	7		69-561-2	30554	93	20
69-503	30554	35	5	69-561-2	30554	93	22
69-504	30554	35	23	69-561-2	30554	93	34
69-505	30554	35	11	69-561-2	30554	93	45
69-506	30554	35		69-561-3	30554	5	4
69-507	30554	35	31	69-561-3	30554	8	11
69-508	30554	35	30	69-561-3	30554	8	21
69-511	30554	35	14	69-561-3	30554	8	28
69-512	30554	22	64	69-561-3	30554	8	34
69-512	30554	22	74	69-561-3	30554	8	37
69-512	30554	35	25	69-561-3	30554	25	18
69-516	30554	22	72	69-561-3	30554	27	9
69-530	30554	7		69-561-3	30554	27	34
69-532	30554	7	15	69-561-3	30554	31	8
69-533	30554	7	17	69-561-3	30554	33	20
69-536	30554	7	6	69-561-3	30554	33	39
69-539-2	30554	85	26	69-561-3	30554	33	55
69-539-2	30554	84	22	69-561-3	30554	33	58
69-540	30554	7	22	69-561-3	30559	8	59
69-541	30554	7	32	69-561-3	30554	65	34
69-542	30554	7	28	69-561-4	30554	8	31
69-543	30554	7	30	69-561-4	30554	8	63
69-543	30554	33	98	69-561-4	30554	8	66
69-545	30554	7	35	69-561-4	30554	93	39
69-547	30554	8	24	69-561-4	30554	97	19
69-548	30554	8	40	69-561-5	30554	33	23
69-549	30554	8	47	69-561-5	30554	33	25
69-561-1	30554	25	34	69-561-5	30554	97	20
69-561-1	30554	33	61	69-561-6	30554	33	5
69-561-1	30554	33	141	69-561-6	30554	33	13
69-561-1	30554	89	16	69-561-6	30554	33	25
69-561-1	30554	93	47	69-561-6	30554	33	28
69-561-2	30554	3	4	69-561-6	30554	33	42
69-561-2	30554	8	76	69-561-6	30554	33	44
69-561-2	30554	25	14	69-561-6	30554	33	51
69-561-2	30554	25	25	69-5614	30554	97	5
69-561-2	30554	25	28	69-570-3	30554	5	8
69-561-2	30554	26	46	69-571-1	30554	8	50
69-561-2	30554	27	30	69-571-2	30554	31	6
69-561-2	30554	27	44	69-572	30554	8	57
69-561-2	30554	31	22	69-574	30554	8	9
69-561-2	30554	31	32	69-575	30554	8	8
69-561-2	30554	31	36	69-576-1	30554	8	6
69-561-2	30554	33	17	69-576-2	30554	8	7

SECTION IV. NATIONAL STOCK NUMBER AND REFERENCE NUMBER INDEX (CONT.)

REFERENCE NO.	MFG. CODE	FIG. NO.	ITEM NO.	REFERENCE NO.	MFG. CODE	FIG. NO.	ITEM NO.
69-578	30554	8	13	69-651-1	30554	31	39
69-579	30554	8	13	69-651-2	30554	27	33
69-580	30554	5	3	69-651-3	30554	8	62
69-581	30554	5	7	69-654	30554	89	4
69-582	30554	5	9	69-655	30554	89	20
69-583	30554	5	6	69-656	30554	89	15
69-589-1	30554	8	30	69-657	30554	13	12
69-589-2	30554	8	30	69-658	30554	8	72
69-590-1	30554	8		69-658	30554	27	50
69-590-2	30554	8		69-659	30554	88	5
69-590-4	30554	8	2	69-659	30554	92	7
69-591	30554	8	79	69-661-14	30554	27	78
69-592	30554	8	83	69-661-14	30554	9	12
69-592	30554	8	78	69-662-17	30554	89	3
69-593	30554	8	18	69-662-17	30554	1	26
69-594	30554	8	19	69-662-18	30554	3	2
69-595	30554	8		69-662-18	30554	3	11
69-596	30554	8		69-662-18	30554	7	5
69-597	30554	8	16	69-662-18	30554	7	7
69-598	30554	8	16	69-662-18	30554	7	16
69-599	30554	8	17	69-662-18	30554	7	21
69-601	30554	55	24	69-662-18	30554	25	22
69-602	30554	55	19	69-662-18	30554	27	16
69-603	30554	55		69-662-18	30554	31	16
69-604	30554	55		69-662-18	30554	31	20
69-605	30554	55		69-662-18	30554	93	21
69-606	30554	55		69-662-20	30554	93	35
69-607	30554	55		69-662-20	30554	93	46
69-608	30554	55		69-662-20	30554	98	4
69-609	30554	55		69-662-3	30554	4	2
69-610	30554	55		69-662-3	30554	25	24
69-612	30554	55		69-662-3	30554	27	13
69-615	30554	55		69-662-3	30554	27	15
69-616	30554	55		69-662-3	30554	27	26
69-617	30554	55		69-662-3	30554	27	45
69-618	30554	55		69-662-3	30554	93	48
69-619	30554	55		69-662-3	30554	97	24
69-620	30554	55		69-662-32	30554	47	22
69-621	30554	55		69-662-33	30554	7	32
69-622	30554	55		69-662-33	30554	25	8
69-624	30554	55		69-662-33	30554	25	11
69-625	30554	55		69-662-33	30554	25	13
69-629	30554	55		69-662-33	30554	31	17
69-630	30554	55		69-662-33	30554	31	40
69-631	30554	55		69-662-33	30554	31	42
69-632	30554	55		69-662-33	30554	35	1
69-633	30554	55		69-662-34	30554	93	25
69-650	30554	37		69-662-34	30554	93	30
69-651-1	30554	25	17	69-662-34	30554	93	42

SECTION IV. NATIONAL STOCK NUMBER AND REFERENCE NUMBER INDEX (CONT.)

REFERENCE NO.	MFG. CODE	FIG. NO.	ITEM NO.	REFERENCE NO.	MFG. CODE	FIG. NO.	ITEM NO.
69-662-35	30554	84	47	69-716	30554	22	50
69-662-35	30554	102	12	69-717-1	30554	22	77
69-662-49	30554	93	40	69-717-2	30554	22	65
69-662-50	30554	98	16	69-717-3	30554	22	79
69-662-64	30554	3	1	69-717-4	30554	22	102
69-662-64	30554	13	69	69-718	30554	22	63
69-662-64	30554	21	22	69-719	30554	22	56
69-662-64	30554	21	26	69-725	30554	22	13
69-662-64	30554	21	30	69-726	30554	22	38
69-662-64	30554	21	34	69-727-1	30554	22	43
69-662-64	30554	21	42	69-727-2	30554	22	48
69-662-64	30554	21	48	69-728-1	30554	22	100
69-662-64	30554	25	4	69-728-2	30554	22	101
69-662-64	30554	25	6	69-728-3	30554	22	
69-662-64	30554	27	6	69-728-4	30554	22	
69-662-64	30554	31	4	69-728-5	30554	22	
69-662-64	30554	84	19	69-728-6	30554	22	103
69-662-64	30554	89	2	69-728-7	30554	22	
69-662-64	30554	92	23	69-731	30554	22	
69-662-64	30554	95	30	69-732-1	30554	22	104
69-662-64	30554	99	1	69-732-2	30554	22	104
69-662-66	30554	21	50	69-733-2	30554	22	95
69-662-78	30554	21	43	69-734	30554	22	62
69-668	30554	87	3	69-735	30554	22	68
69-669	30554	3	7	69-736	30554	22	33
69-677	30554	9		69-738-1	30554	22	19
69-691	30554	3	12	69-738-2	30554	22	17
69-692-4	30554	21	20	69-738-3	30554	22	21
69-692-6	30554	84	39	69-738-4	30554	22	20
69-693-2	30554	8	84	69-738-5	30554	22	18
69-694-6	30554	8	4	69-738-6	30554	22	15
69-695	30554	8	3	69-739	30554	8	74
69-696	30554	8	14	69-739	30554	27	57
69-697-4	30554	75	15	69-740	30554	27	56
69-698	30554	55	6	69-741	30554	27	51
69-700	12670	22		69-763	30554	8	24
69-702	30554	22	61	69-764	30554	8	75
69-704	30554	22	78	69-765	30554	8	64
69-705	30554	22	76	69-766	30554	8	5
69-710	30554	22	32	69-767	30554	27	61
69-711	30554	22	14	69-768	30554	27	46
69-712	30554	22	99	69-771	30554	13	6
69-713-1	30554	22	49	60-771	30554	13	13
69-713-3	30554	22	67	69-771	30554	13	18
69-713-3	30554	22	75	69-771	30554	13	23
69-713-3	30554	22	80	69-771	30554	13	31
69-713-4	30554	22	75	69-771	30554	13	36
69-713-5	30554	22	51	69-771	30554	13	42
69-715	30554	22	73	69-771	30554	13	48

SECTION IV. NATIONAL STOCK NUMBER AND REFERENCE NUMBER INDEX (CONT.)

REFERENCE NO.	MFG. CODE	FIG. NO.	ITEM NO.	REFERENCE NO.	MFG. CODE	FIG. NO.	ITEM NO.
69-772-2	30554	87		70-1137	30554	25	10
69-773	30554	8	14	70-1138	30554	25	12
69-774	30554	85	34	70-1140	30554	27	42
69-774	30554	92	20	70-1141	30554	31	41
69-775	30554	90		70-1172	30554	21	32
69-779-1	30554	63	1	70-117224	80089	27	42
69-781	30554	75	11	70-1229	30554	93	5
69-782	30554	50	12	70-1230	30554	93	44
69-784-1	30554	22		70-1231	30554	93	43
69-784-2	30554	22		70-1232	30554	93	
69-785	30554	35		70-1233	30554	93	49
69-787-2	30554	47	15	70-1251	30554	93	5
69-787-2	30554	53		70-1282	30554	93	27
69-790-3	30554	54		70-1283	30554	93	28
69-790-3	30554	53		70-1284	30554	93	33
69-800	12670	22		70-1285	30554	93	41
69-801	12670	22	33	70-1286	30554	93	37
69-805	30554	22	73	70-1290	30554	99	30
69-806	30554	22	63	70-1292	30554	99	34
69-810	30554	22	38	70-1310	30554	101	6
69-811-2	30554	22	48	70-1329	30554	87	
69-814	30554	22		70-1332	30554	87	
6939A	28265	63	3	70-1341	30554	87	
6939A	28265	74	11	70-1397	30554	92	27
696	79470	84	23	70-1416	30554	92	32
6957A	28265	67	5	70-1417	30554	98	25
7-75	31211	58	3	70-1434	30554	88	34
7-8	31211	58	4	70-1466	30554	93	38
7-809	95026	97	43	70-1481	30554	87	
7-914	95026	97	22	70-1484	30554	15	21
70-1050-1	30554	93	26	70-1489	30554	92	5
70-1050-2	30554	93	36	70-1491-36	30554	85	
70-1105-1	30554	53		70-1492	30554	92	26
70-1105-1	30554	62		70-1494-6	30554	88	11
70-1105-2	30554	62		70-1495-4	30554	88	24
70-1105-4	30554	61		70-1498	30554	88	12
70-1109-13	30554	88	4	70-1500	30554	88	20
70-1109-13	30554	92	4	70-1511	30554	13	54
70-1109-37	30554	55	24	70-1512	30554	84	5
70-1109-6	30554	85	21	70-1524	30554	31	27
70-1111	30554	54	12	70-1528	30554	93	25
70-1112-36	30554	85		70-1529-26	30554	98	3
70-1112-73	30554	85	6	70-1531-2	52660	50	30
70-1118	30554	31	43	70-1531-2	52660	50	40
70-1119	30554	31	41	70-1531-2	30554	97	7
70-1120	30554	31	18	70-1580	30554	3	6
70-1132	30554	25	7	70-1592-1	30554	92	31
70-1135	30554	25		70-1592-2	30554	88	13
70-1136	30554	25	9	70-1594	30554	47	16

SECTION IV. NATIONAL STOCK NUMBER AND REFERENCE INDEX (CONT.)

Reference Number	Mfg. Code	Fig. No.	Item No.	Reference Number	Mfg. Code	Fig. No.	Item No.
70-1599	30554	47	23	72-212	30554	54	13
70-1608	30554	47	3	72-3002-2	30554	51	27
70-1609	30554	47	14	72-2003	30554	51	20
70-1610	30554	47	7	72-2004	30554	57	14
70-1611	30554	47	2	72-2007	30554	51	10
70-1614	30554	93	6	72-2009	30554	13	98
70-1615-3	30554	94	2	72-2010	30554	50	33
70-1615-7	30554	94	1	72-2011	30554	50	
70-222	30554	55	3	72-2012	30554	50	23
70-4012	30554	8	15	72-2013	30554	50	18
70-4016	30554	8	20	72-2014	30554	50	17
70-501	30554	21	43	72-2015	30554	51	
70-501	30554	21	49	72-2015-8	30554	51	3
70-501-1	30554	21	49	71-2018	30554	84	11
70-501-2	30554	19		71-2019-2	30554	101	10
70-502	30554	13	74	71-2021	30554	57	6
70-507	30554	48		72-2023-1	30554	55	20
70-507-3	30554	48	4	72-2023-2	30554	55	21
70-507-11	30554	48	11	72-2024	30554	79	26
70-508	30554	48	1	72-2025-1	30554	85	9
70-512-2	30554	22	94	72-2025-1	30554	95	13
70-512-3	30554	22	86	72-2025-1	30554	85	20
70-514	30554	7	26	72-2025-2	30554	53	5
70-515	30554	7	34	72-2026	30554	51	20
70D43103S01	31211	58		72-2029	30554	14	51
7002-018	92742	93	41	72-2031	30554	1	24
7008-20	55070	66	8	72-2032	30554	84	17
7008-34C	55070	66	2	72-2033	20554	56	6
7008-35	55070	66	5	72-2035	30554	13	71
7008-36A	55070	66	4	72-2035	30554	84	34
7008-42B	10260	66	12	72-2038	30554	13	112
7008-49T	55070	66	7	72-2039	30554	37	25
7008-571	55070	66	10	72-2040	30554	37	20
7008-711	55070	66	9	72-2041	30554	37	12
7046-025	95026	97	76	72-2042	30554	14	3
7046-040	95026	97	75	72-2043	30554	85	3
7047.3	95026	97	79	72-2044	30554	1	33
7047-5	95026	97	81	72-2045	30554	13	92
7047-6	95026	97	78	72-2046	30554	13	87
7064-1	95026	97	70	72-2047	30554	84	18
7064-2	95026	97	69	72-2049	30554	13	68
7064-3	95026	97	66	72-2050-2	30554	2	2
7064-4	95026	97	65	72-2051	20554	2	5
7064-5	95026	97	64	72-2052	30554	59	8
7086700	19207	77	38	72-2053	30554	2	5
7165A	19207	83	20	72-2054-2	30554	2	11
72-0504-7	30554	87		72-2055	30554	51	14
72-1868-3	30554	99	11	72-2056	30554	51	12
72-2001	30554	84	46	72-2057	30554	2	12

SECTION IV. NATIONAL STOCK NUMBER AND REFERENCE NUMBER INDEX (CONT.)

REFERENCE NO.	MFG. CODE	FIG. NO.	ITEM NO.	REFERENCE NO.	MFG. CODE	FIG. NO.	ITEM NO.
72-2058	30554	21	33	72-2112	30554	56	19
72-2059	30554	21	39	72-2115	30554	87	9
72-2060	30554	24	7	72-2117	30554	24	11
72-2061-1	30554	21	9	72-2118	30554	14	1
72-2061-2	30554	21	18	72-2119	30554	85	18
72-2062-2	30554	21	8	72-2120	30554	13	53
72-2062-2	30554	21	19	72-2120	30554	53	13
72-2063	30554	22	10	72-2122	30554	86	7
72-2064	30554	22	6	72-2123	30554	86	14
72-2065	30554	13	61	72-2125	30554	86	15
72-2067-1	30554	1	20	72-2126	30554	86	8
72-2067-2	30554	22	3	72-2128	30554	84	3
72-2068	30554	22	9	72-2132	30554	56	5
72-2070	30554	13	11	72-2133	30554	15	20
72-2071	30554	13	41	72-2134	30554	13	22
72-2072	30554	13	47	72-2136	30554	84	44
72-2073	30554	13	35	72-2137	30554	2	10
72-2074	30554	13	30	72-2138	30554	13	7
72-2079	30554	13	5	72-2138	30554	13	32
72-2080	30554	13	65	72-2138	30554	13	37
72-2082	30554	31	25	72-2138	30554	13	43
72-2083	30554	84	13	72-2138	30554	13	49
72-2084	30554	85	23	72-2142	30554	13	27
72-2085	30554	85	24	72-2143	30554	56	6
72-2086	30554	85	25	72-2144	30554	21	14
72-2090	30554	1	19	72-2145	30554	21	3
72-2091	30554	24	4	72-2146	30554	86	16
72-2094	30554	86	6	72-2147	30554	65	37
72-2095	30554	13	103	72-2149	30554	47	1
72-2096	30554	13	108	72-2151-1	30554	85	8
72-2098-1	30554	21	4	72-2151-1	30554	85	10
72-2098-2	30554	21	16	72-2153	30554	85	11
72-2098-3	30554	21	15	72-2153-1	30554	85	12
72-2099-1	30554	37	4	72-2154	30554	63	18
72-2099-2	30554	55		72-2155	30554	52	3
72-2099-3	30554	53	67	72-2156	30554	2	
72-2100	30554	47	21	72-2157	30554	2	
72-2102	30554	52	6	72-2163	30554	53	4
72-2105	30554	13	82	72-2164	30554	67	1
72-2106	30554	12	75	72-2166	30554	74	17
72-2108	30554	13	17	72-2167	30554	88	7
72-2109	30554	53	66	72-2167	30554	92	8
72-2110-1	30554	86	2	72-2168-1	30554	92	12
72-2110-2	30554	86	4	72-2168-2	30554	55	18
72-2110-3	30554	86	4	72-2168-3	30554	53	18
72-2110-4	30554	86	3	72-2169	30554	92	13
72-2110-5	30554	51	18	72-2170	30554	88	10
72-2110-6	30554	51	16	72-2172	30554	88	22
72-2111	30554	84	31	72-2173-1	30554	88	23

SECTION IV. NATIONAL STOCK NUMBER AND REFERENCE INDEX (CONT.)

Reference Number	Mfg. Code	Fig. No.	Item No.	Reference Number	Mfg. Code	Fig. No.	Item No.
72-2173-2	30554	88	9	72-2260	30554	31	
72-2174	30554	65	36	72-2264	30554	31	21
72-2174	30554	84	1	72-2265	30554	31	35
72-2176	30554	13	4	72-2266	30554	21	39
72-2202	30554	51	7	72-2271	30554	84	20
72-2203-1	30554	61		72-2274	30554	3	
72-2203-1	54125	61		72-2275	30554	3	14
72-2203-2	30554	62		72-2276	30554	3	16
72-2203-2	54125	61		72-2278	30554	63	2
72-2204	30554	27	36	72-2279-2	30554	8	80
72-2206	30554	65		72-2280	30554	1	39
72-2207	30554	74	3	72-2281-1	30554	1	1
72-2208	30554	74	31	72-2281-1	30554	51	17
72-2209	30554	25		72-2281-2	30554	1	7
72-2210	30554	25	5	72-2281-3	30554	1	12
72-2210	30554	31	5	72-2282	30554	17	
72-2211	30554	25	23	72-2283	30554	13	55
72-2213	30554	21	7	72-2284	30554	15	
72-2215-2	30554	21	21	72-2286	30554	4	
72-2216	30554	21	29	72-2288	30554	34	15
72-2217	30554	51	19	72-2289-1	30554	51	17
72-2218	30554	59		72-2290-2	30554	18	
72-2219	30554	59	7	72-2291-2	30554	1	28
72-2220	30554	29		72-2294-2	30554	84	40
72-2221-2	30554	21	17	72-2297-1	30554	47	17
72-2224	30554	26		72-2297-2	30554	84	23
72-2226	30554	25	37	72-2299	30554	47	12
72-2228	30554	31		72-2390	30554	84	
72-2229	30554	21	40	72-2391	30554	84	
72-2230	30554	21	40	72-2402	30554	45	24
72-2231	30554	6	1	72-2403	30554	45	8
72-2232	30554	27		72-2403	30554	46	8
72-2233	30554	27	5	72-2411	30554	40	4
72-2234	30554	36		72-2412	30554	43	3
72-2235	30554	26	38	72-2413	30554	41	7
72-2236	30554	21	10	72-2414	30554	43	4
72-2237	30554	32	5	72-2427	30554	45	
72-2238	30554	28		72-2429	30554	46	
72-2239	30554	27		72-2430	30554	42	3
72-2241	30554	27	18	72-2435	30554	38	7
72-2242	30554	31		72-2436	30554	40	6
72-2243	30554	25		72-2442	30554	40	5
72-2244	30554	31	44	72-2448	30554	38	13
72-2245	30554	32		72-2449	30554	38	17
72-2247	30554	11		72-2451	30554	40	39
72-2248	30554	30		72-2457	30554	38	10
72-2250-2	30554	57		72-2458	30554	38	14
72-2250-2	31211	58		72-2459-3	30554	38	25
72-2253	30554	31		72-2459-4	30554	38	25
72-2259	30554	10					

SECTION IV. NATIONAL STOCK NUMBER AND REFERENCE NUMBER INDEX (CONT.)

REFERENCE NO.	MFG. CODE	FIG. NO.	ITEM NO.	REFERENCE NO.	MFG. CODE	FIG. NO.	ITEM NO.
72-2469	30554	42	4	72-2829	30554	100	
72-2480	30554	43	5	72-2830	30554	101	
72-2489	30554	44		72-2832	30554	99	9
72-2492	30554	43		72-2833	30554	97	
72-2500	30554	38		72-2834	30554	97	
72-2550	30554	38		72-2836	30554	92	
72-2600	30554	33		72-2837	30554	88	
72-2601	30554	33		72-2839	30554	97	2
72-2602	30554	33	139	72-2848	30554	92	25
72-2603	30554	33	139	72-2849	30554	92	30
72-2604	30554	33	74	72-2855	30554	95	
72-2405	30554	33	4	72-2856	30554	91	
72-2606	30554	33	8	72-2857	30554	92	21
72-2607	30554	33	22	72-2860	30554	92	34
72-2609	30554	33	29	72-2861	30554	92	33
72-2610	30554	33	140	72-2866	30554	98	6
72-2611	30554	33	76	72-2868-1	30554	99	17
72-2612-1	30554	33	38	72-2868-2	30554	99	20
72-2612-2	30554	33	38	72-2868-4	30554	99	14
72-2513-1	30554	33	57	72-2868-5	30554	99	26
72-2613-2	30554	33	60	72-2868-5	30554	99	23
72-2614-1	30554	33	37	72-2871	30554	103	
72-2614-2	30554	33	37	72-2872	30554	102	
72-2615	30554	33	48	72-2973	30554	88	32
72-2616	30554	33	76	72-2874	30554	98	
72-2618	30554	33	41	72-2875	30554	96	
72-2619	30554	33	29	72-2907	30554	87	
72-2620	30554	33	16	72-2908	30554	87	
72-2621	30554	33	15	72-2909	30554	87	
72-2622	30554	33	82	72-2910	30554	87	
72-2623	30554	33	126	72-2911	30554	87	
72-2624	30554	33	108	72-2914	30554	87	
72-2627	30554	33	143	72-2915	30554	87	
72-2628	30554	33	63	72-2916	30554	87	
72-2633	30554	33	24	72-2919	30554	87	
72-2800	30554	99	36	72-2920	30554	87	
72-2801	30554	98	27	72-2925	30554	87	
72-2803	30554	99	2	72-2926	30554	87	
72-2805	30554	101	1	72-2928	30554	87	
72-2807	30554	99	29	72-2929	30554	87	
72-2808	30554	99		72-2930	30554	87	
72-2810-2	30554	89	22	72-2931	30554	87	
72-2812	30554	98	18	72-2934	30554	87	
72-2818	30554	98	17	72-2935	30554	87	
72-2821	30554	99	33	72-2941-2	30554	87	
72-2822	30554	107		72-502-1	30554	22	93
72-2823	30554	106		75-502-2	30554	22	85
72-2825	30554	105		72-503	30554	22	29
72-2828	30554	104		7238X2	79470	55	9

TM9-6115-465-24P
 TO 35C2-3-446-4
 NAVFAC P-8-625-24P
 SL-4-06858B/06859D

SECTION IV. NATIONAL STOCK NUMBER AND REFERENCE NUMBER INDEX (CONT.)

REFERENCE NO.	MFG. CODE	FIG. NO.	ITEM NO.	REFERENCE NO.	MFG. CODE	FIG. NO.	ITEM NO.
73-0507	30554	8	10	8142-6	95026	97	55
73-2279-12IN	41625	8	80	8142-7	95026	97	63
74-7016	95026	97	31	8142-8	95026	97	62
74F01DA103	06001	22	103	817010	54125	61	10
74F01DA105	06001	22	100	8170613	54125	61	9
74F01DA224	02003	22		8170614	51425	61	5
74F91DA473	06001	22		8170616	54125	61	3
74F91DA474	06001	22		8170619	54125	61	2
74F01DA564	06001	22	101	8180100	54125	61	11
74F01DC104	06001	22		82283	89584	90	61
75-0851	30554	27	8	83-2001	30554	60	1
750893	30554	84	35	83-2002	30554	60	2
76036A	28265	76	9	83-2012	30554	16	3
78109A	28265	80	12	84-704	30554	16	
76109A	28265	83	40	85-15-200-16	94222	13	55
77019A	28265	77	26	85-2000-1	30554	42	5
77112A	28265	81	9	85-2000-2	30554	42	6
779-512	30554	22	88	85-34-101-17	94222	13	54
8-4CTKS	30780	92	12	8552A	28265	80	5
8-410	95026	97	82	8692DX	77890	74	3
8-8CTKB	45681	92	4	87A	28265	76	4
8-8FTXS	45681	92	6	887047PG13	10001	68	12
8FTX	45681	63	16	8906K1359	37192	8	57
80-0901-0511-203	72619	99	34	9-148	95026	97	20
801-042	54125	61	7	9-207	95026	97	29
801-043	51425	61	6	90-2378	19728	57	23
801-058	51425	61	8	90-2379	18728	57	24
809650	04009	3	12	90-33	19728	57	20
81-2002	30554	84	26	9048200920	9720	25	7
81-4903	30554	23	1	9200	96026	97	35
81-4917	30554	16	5	9305-001	74063	18	39
81-704	30554	54	2	9409949	83945	83	18
81-705	30554	54	1	98292-2-250	96530	8	4
8142-1	95026	97	52	9947P130	60119	8	85
8142-3	95026	97	58	99836	96530	8	3
8142-5	85026	97	57				
8142-5	95026	97	56				

By Order of the Secretaries of the Army, Air Force, and Navy (Including the Marine Corps):

GORDON R. SULLIVAN
General, United States Army
Chief of Staff

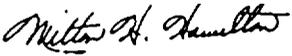
MILTON H. HAMILTON
Administrative Assistant to the
Secretary of the Army
01650

MERRILL A. McPEAK
General, USAF
Chief of Staff

Official:

CHARLES C. McDONALD
General, USAF
Commander Air Force Logistics Command

DAVID E. BOTTORFF
Rear Admiral, CEC, US Navy
Commander
Navy Facilities Engineering Command

H. E. REESE
Deputy for Support
Marine Corps Research, Development and
Acquisition Command

DISTRIBUTION:

To be distributed in accordance with DA Form 12-25E, qty rqr block no. 0851.

RECOMMENDED CHANGES TO EQUIPMENT TECHNICAL PUBLICATIONS



THEN... JOT DOWN THE DOPE ABOUT IT ON THIS FORM. CAREFULLY TEAR IT OUT. FOLD IT AND DROP IT IN THE MAIL!

SOMETHING WRONG WITH THIS PUBLICATION?

FROM: (PRINT YOUR UNIT'S COMPLETE ADDRESS)

PFC JOHN DOE
COA, 3d ENGINEER BN
FT. LEAVELAND, MO 63108

DATE SENT

PUBLICATION NUMBER

TM 9-6115-465-24P

PUBLICATION DATE

3 JUNE 1992

PUBLICATION TITLE

Generator Set, Diesel Engine Driven

BE EXACT PIN-POINT WHERE IT IS

PAGE NO	PARA-GRAPH	FIGURE NO	TABLE NO
---------	------------	-----------	----------

6

2-1
a

B1

4-3

125

line 20

IN THIS SPACE TELL WHAT IS WRONG AND WHAT SHOULD BE DONE ABOUT IT:

In line 6 of paragraph 2-1a the manual states the engine has 6 cylinders. The engine on my set only has 4 cylinders. Change the manual to show 4 cylinders.

Callout 16 on figure 4-3 is pointing at a bolt. In key to figure 4-3, item 16 is called a skin - Please correct one or the other.

I ordered a gasket, item 19 on figure B-16 by NSN 2 910-05-762-3001. I got a gasket but it doesn't fit. Supply says I got what I ordered, so the NSN is wrong. Please give me a good NSN

PRINTED NAME, GRADE OR TITLE AND TELEPHONE NUMBER

JOHN DOE, PFC (268) 317-7111

SIGN HERE

JOHN DOE

DA FORM 1 JUL 79 2028-2

PREVIOUS EDITIONS ARE OBSOLETE.
DRSTS-M Overprint 1, 1 Nov 80

P.S. --IF YOUR OUTFIT WANTS TO KNOW ABOUT YOUR RECOMMENDATION MAKE A CARBON COPY OF THIS AND GIVE IT TO YOUR HEADQUARTERS

TEAR ALONG PERFORATED LINE

FILL IN YOUR
UNIT'S ADDRESS



FOLD BACK

DEPARTMENT OF THE ARMY

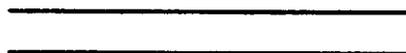

OFFICIAL BUSINESS

COMMANDER
U.S. ARMY TROOP SUPPORT COMMAND
ATTN: AMSTR-MMTS
4300 GOODFELLOW BOULEVARD
ST. LOUIS, MO 63120-1798

TEAR ALONG PERFORATED LINE

RECOMMENDED CHANGES TO EQUIPMENT TECHNICAL PUBLICATIONS



THEN... JOT DOWN THE DOPE ABOUT IT ON THIS FORM. CAREFULLY TEAR IT OUT. FOLD IT AND DROP IT IN THE MAIL!

SOMETHING WRONG WITH THIS PUBLICATION?

FROM: (PRINT YOUR UNIT'S COMPLETE ADDRESS)

DATE SENT

PUBLICATION NUMBER

TM 9-6115-465-24P

PUBLICATION DATE

3 JUNE 1992

PUBLICATION TITLE

Generator Set, Diesel Engine Driven

BE EXACT PIN-POINT WHERE IT IS

PAGE NO	PARA-GRAPH	FIGURE NO	TABLE NO

IN THIS SPACE TELL WHAT IS WRONG AND WHAT SHOULD BE DONE ABOUT IT:

TEAR ALONG PRECUTTED LINE

PRINTED NAME, GRADE OR TITLE AND TELEPHONE NUMBER

SIGN HERE

DA FORM 2028-2
1 JUL 79

PREVIOUS EDITIONS ARE OBSOLETE.
DRSTS-M Overprint 2, 1 Nov 88.

P.S.--IF YOUR OUTFIT WANTS TO KNOW ABOUT YOUR RECOMMENDATION MAKE A CARBON COPY OF THIS AND GIVE IT TO YOUR HEADQUARTERS

FILL IN YOUR
UNIT'S ADDRESS



FOLD BACK

DEPARTMENT OF THE ARMY

OFFICIAL BUSINESS

COMMANDER
U.S. ARMY TROOP SUPPORT COMMAND
ATTN: AMSTR-MMTS
4300 GOODFELLOW BOULEVARD
ST. LOUIS, MO 63120-1798

TEAR ALONG PERFORATED LINE

FILL IN YOUR
UNIT'S ADDRESS



FOLD BACK

DEPARTMENT OF THE ARMY

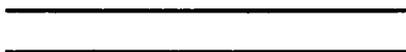

OFFICIAL BUSINESS

COMMANDER
U.S. ARMY TROOP SUPPORT COMMAND
ATTN: AMSTR-MMTS
4300 GOODFELLOW BOULEVARD
ST. LOUIS, MO 63120-1798

TEAR ALONG PERFORATED LINE

RECOMMENDED CHANGES TO EQUIPMENT TECHNICAL PUBLICATIONS



THEN... JOT DOWN THE DOPE ABOUT IT ON THIS FORM. CAREFULLY TEAR IT OUT. FOLD IT AND DROP IT IN THE MAIL!

SOMETHING WRONG WITH THIS PUBLICATION?

FROM: (PRINT YOUR UNIT'S COMPLETE ADDRESS)

DATE SENT

PUBLICATION NUMBER

TM 9-6115-465-24P

PUBLICATION DATE

3 JUNE 1992

PUBLICATION TITLE

Generator Set, Diesel Engine Driven

BE EXACT. PIN-POINT WHERE IT IS

PAGE NO

PARA-GRAPH

FIGURE NO

TABLE NO

IN THIS SPACE TELL WHAT IS WRONG AND WHAT SHOULD BE DONE ABOUT IT:

FORM LONG PERFORATED LINE

PRINTED NAME, GRADE OR TITLE, AND TELEPHONE NUMBER

SIGN HERE:

DA FORM 2028-2
1 JUL 79

PREVIOUS EDITIONS ARE OBSOLETE.
DRST&M Overprint 2, 1 Nov 80.

P.S.--IF YOUR OUTFIT WANTS TO KNOW ABOUT YOUR RECOMMENDATION MAKE A CARBON COPY OF THIS AND GIVE IT TO YOUR HEADQUARTERS.

FILL IN YOUR
UNIT'S ADDRESS



FOLD BACK

DEPARTMENT OF THE ARMY

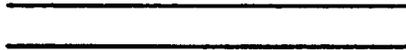

OFFICIAL BUSINESS

COMMANDER
U.S. ARMY TROOP SUPPORT COMMAND
ATTN: AMSTR-MMTS
4300 GOODFELLOW BOULEVARD
ST. LOUIS, MO 63120-1798

TEAR ALONG PERFORATED LINE

The Metric System and Equivalents

Linear Measure

1 centimeter = 10 millimeters = .39 inch
 1 decimeter = 10 centimeters = 3.94 inches
 1 meter = 10 decimeters = 39.37 inches
 1 dekameter = 10 meters = 32.8 feet
 1 hectometer = 10 dekameters = 328.08 feet
 1 kilometer = 10 hectometers = 3,280.8 feet

Weights

1 centigram = 10 milligrams = .15 grain
 1 decigram = 10 centigrams = 1.54 grains
 1 gram = 10 decigram = .035 ounce
 1 dekagram = 10 grams = .35 ounce
 1 hectogram = 10 dekagrams = 3.52 ounces
 1 kilogram = 10 hectograms = 2.2 pounds
 1 quintal = 100 kilograms = 220.46 pounds
 1 metric ton = 10 quintals = 1.1 short tons

Liquid Measure

1 centiliter = 10 milliliters = .34 fl. ounce
 1 deciliter = 10 centiliters = 3.38 fl. ounces
 1 liter = 10 deciliters = 33.81 fl. ounces
 1 dekaliter = 10 liters = 2.64 gallons
 1 hectoliter = 10 dekaliters = 26.42 gallons
 1 kiloliter = 10 hectoliters = 264.18 gallons

Square Measure

1 sq. centimeter = 100 sq. millimeters = .155 sq. inch
 1 sq. decimeter = 100 sq. centimeters = 15.5 sq. inches
 1 sq. meter (centare) = 100 sq. decimeters = 10.76 sq. feet
 1 sq. dekameter (are) = 100 sq. meters = 1,076.4 sq. feet
 1 sq. hectometer (hectare) = 100 sq. dekameters = 2.47 acres
 1 sq. kilometer = 100 sq. hectometers = .386 sq. mile

Cubic Measures

1 cu. centimeter = 1000 cu. millimeters = .06 cu. inch
 1 cu. decimeter = 1000 cu. centimeters = 61.02 cu. inches
 1 cu. meter = 1000 cu. decimeters = 35.31 cu. feet

Approximate Conversion Factors

To change	To	Multiply by	To change	To	Multiply by
inches	centimeters	2.540	ounce-inches	newton-meters	.007062
feet	meters	.305	centimeters	inches	.394
yards	meters	.914	meters	feet	3.280
miles	kilometers	1.609	meters	yards	1.094
square inches	square centimeters	6.451	kilometers	miles	.621
square feet	square meters	.093	square centimeters	square inches	.155
square yards	square meters	.836	square meters	square feet	10.764
square miles	square kilometers	2.590	square meters	square yards	1.196
acres	square hectometers	.405	square kilometers	square miles	.386
cubic feet	cubic meters	.028	square hectometers	acres	2.471
cubic yards	cubic meters	.765	cubic meters	cubic feet	35.315
fluid ounces	milliliters	29.573	cubic meters	cubic yards	1.308
pints	liters	.473	milliliters	fluid ounces	.034
quarts	liters	.946	liters	pints	2.113
gallons	liters	3.785	liters	quarts	1.057
ounces	grams	28.349	liters	gallons	.264
pounds	kilograms	.454	grams	ounces	.035
short tons	metric tons	.907	kilograms	pounds	2.205
pound-feet	newton-meters	1.356	metric tons	short tons	1.102
pound. inches	newton-meters	.11296			

Temperature (Exact)

°F Fahrenheit temperature 5/9 (after subtracting 32) Celsius temperature °C

This fine document...

Was brought to you by me:



[Liberated Manuals -- free army and government manuals](#)

Why do I do it? I am tired of sleazy CD-ROM sellers, who take publicly available information, slap “watermarks” and other junk on it, and sell it. Those masters of search engine manipulation make sure that their sites that sell free information, come up first in search engines. They did not create it... They did not even scan it... Why should they get your money? Why are not letting you give those free manuals to your friends?

I am setting this document FREE. This document was made by the US Government and is NOT protected by Copyright. Feel free to share, republish, sell and so on.

I am not asking you for donations, fees or handouts. If you can, please provide a link to liberatedmanuals.com, so that free manuals come up first in search engines:

<A HREF=<http://www.liberatedmanuals.com/>>Free Military and Government Manuals

- Sincerely
Igor Chudov
<http://igor.chudov.com/>
- [Chicago Machinery Movers](#)